



Mars Exploration Rover Coordinate Systems Relevant to Imaging & Rover Motion Counter

Justin Maki

8/6/03



Table of Contents

1. Coordinate Frames
2. Rover Motion Counter
3. Context ID

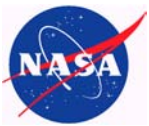

Lander Coordinate Frame (L Frame)



Mars Exploration Rover

- The coordinate frame of the Mars Exploration Rover Lander is right handed, orthogonal, and defined by axes X_L , Y_L , and Z_L , where the origin of the lander coordinate frame is located 1133.5 mm away in the Z_c direction with respect to the cruise coordinate frame.

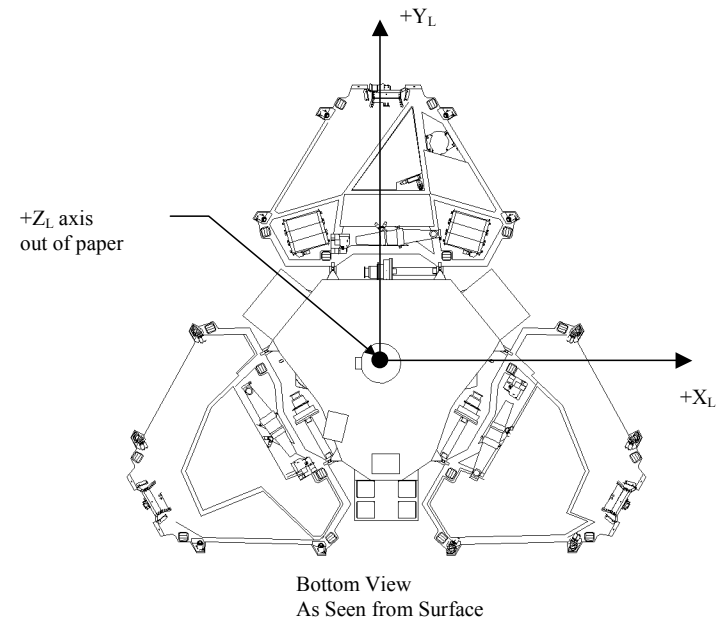
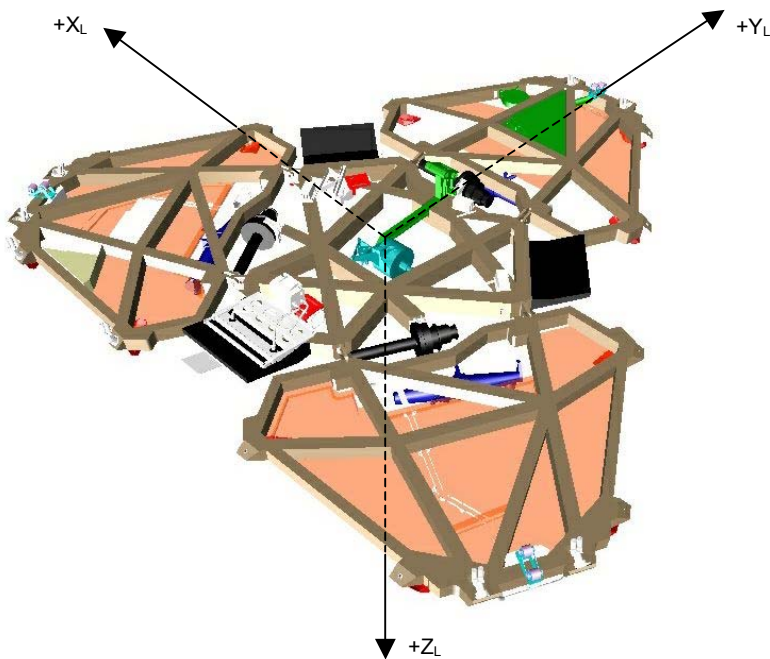



Rover Coordinate Frames



Mars Exploration Rover

- There are two coordinate frames for the MER rover.
- The Rover Mechanical Frame is used by mechanical for the rover design.
- The Rover Traverse Coordinate Frame is used by the navigation and imaging teams during testing and mission operations

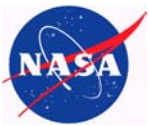

Rover Mechanical Coordinate Frame



Mars Exploration Rover

- The MER rover mechanical coordinate frame is right handed, orthogonal, and defined by axes X_R , Y_R , and Z_R .
- The $+Z_R$ axis emanate from the origin in the X_R/Y_R plane, is normal to the X_C/Y_C plane and points toward the end of the aeroshell, this is the launch direction.
- The origin of the coordinate system is offset from the cruise and lander coordinate frames as described below for the rover in stowed and deployed configurations.

Rover Mechanical Frame Origin

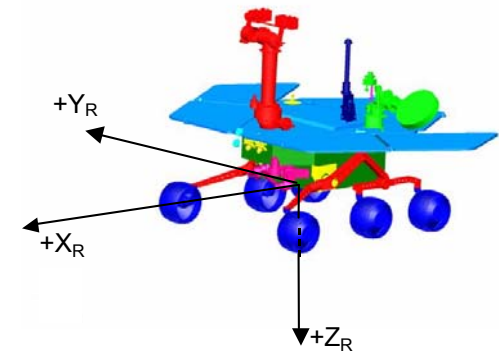
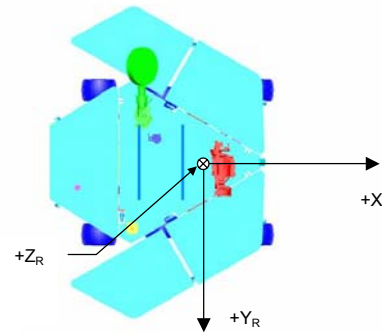
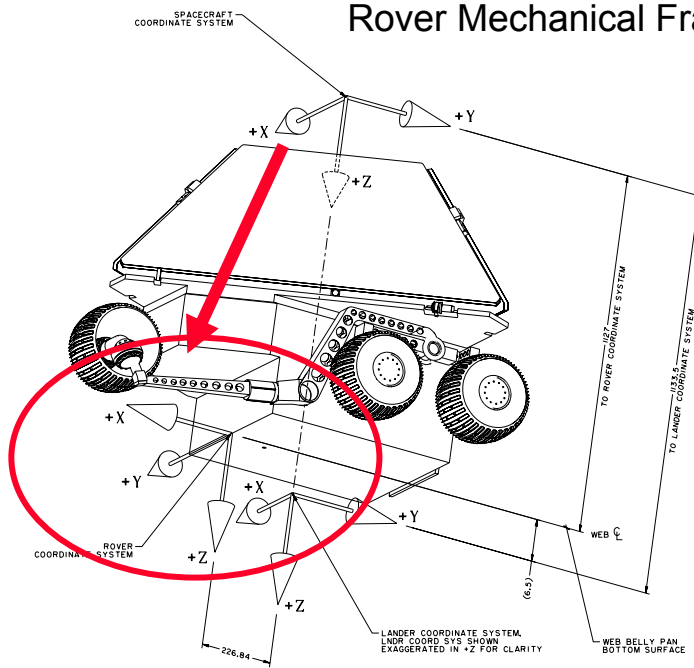

COORDINATE SYSTEM OFFSETS
ROVER +Y MOBILITY, INSTRUMENT DEPLOYMENT DEVICE AND LIFT MECHANISM NOT SHOWN.



Rover Coordinate Frame



Mars Exploration Rover

- The rover navigation (N) frame is used for rover surface navigation.
- The N coordinate system is right handed, orthogonal, and defined by axes X_N , Y_N , and Z_N , where the X_N/Y_N plane is coincident with the X_R/Y_R plane.
- The $+Z_N$ axis emanates from the origin in the X_N/Y_N plane, is anti-normal to the X_R/Y_R plane and points away the cruise stage.
- The Y_N axis is aligned with the middle wheel rotation axis for deployed rover and suspension system on flat plane (gravity vector parallel to Z_N).

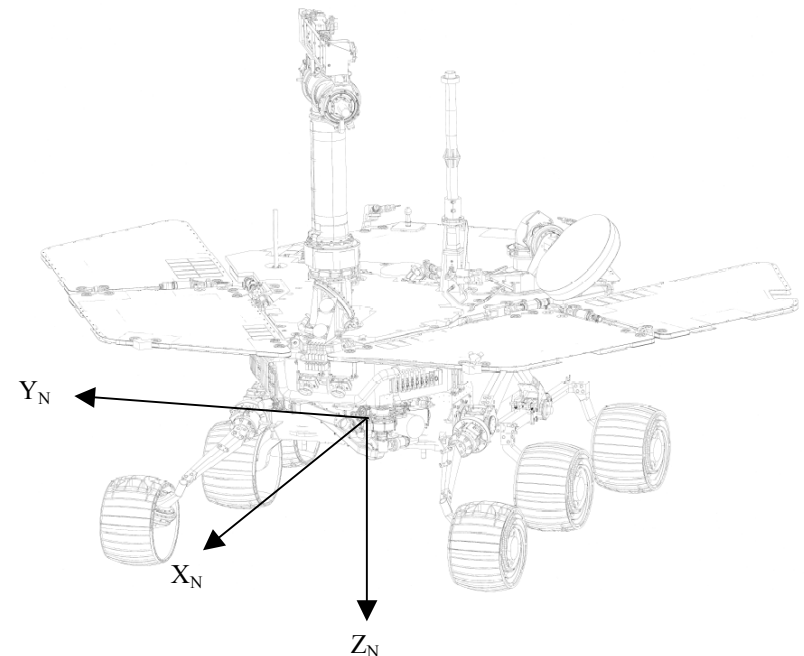
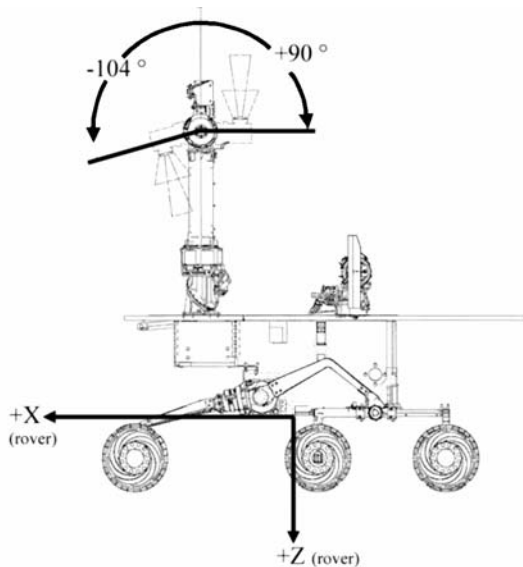

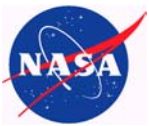

PMA Coordinate Frame



Mars Exploration Rover

- The PMA coordinate system is right handed, orthogonal, and defined by axes X_{PMA} , Y_{PMA} , and Z_{PMA} , where the X_{PMA}/Y_{PMA} plane is defined interface mounting plane between PMA and RED
- The $+Z_{PMA}$ axis emanates from the origin in the X_{PMA}/Y_{PMA} plane, is anti-normal to the X_R/Y_R plane and points toward the cruise stage.

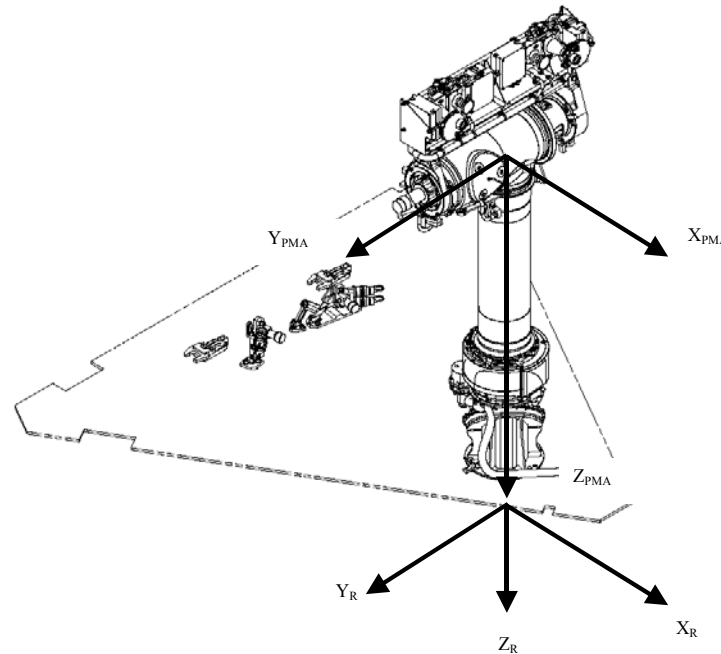



Mars Body Fixed



Mars Exploration Rover

- The Mars body fixed reference axes have their origin at the Mars center-of-mass and are aligned with the spin axis and prime meridian.

- This frame is described as the following:

$+Z_{mbf} \equiv$ Mars spin axis, pointing toward Martian North Pole.

$+X_{mbf} \equiv$ Vector lies in the Mars equatorial plane and intersects the prime meridian.

$+Y_{mbf} \equiv$ Vector lies in the Mars equatorial plane and completes a right handed coordinate system

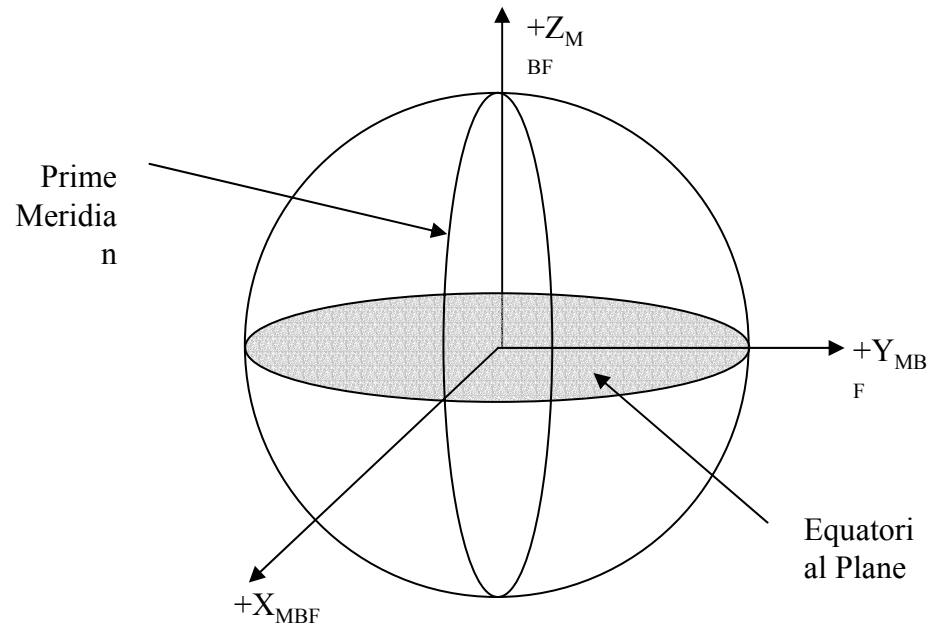



Mars Local Level



Mars Exploration Rover

- The Mars Local Level Coordinate Frame (M Frame) is right handed, orthogonal, and defined by axes X_M , Y_M , and Z_M .
- It is described as a North, East, Nadir frame whose origin is coincident with the Lander L frame.
- There are no translations in any directions with respect to the L frame. It is defined relative to the Mars body fixed frame using radius, r , aerocentric latitude, ϕ , and aerocentric longitude, λ , of the rover frame as follows:

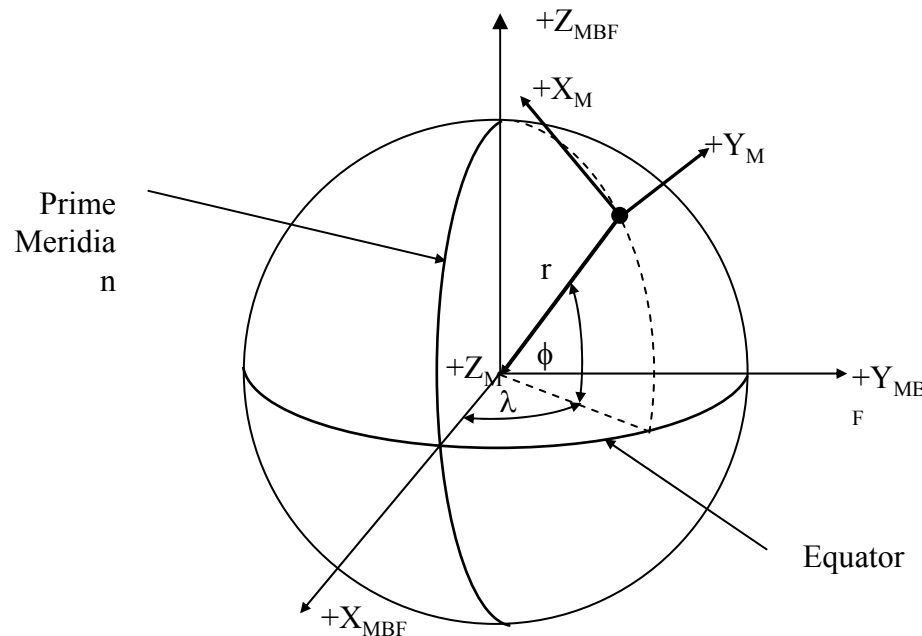



Site Frame



Mars Exploration Rover

- The Site Frame (S) is described as a North, East, Nadir frame whose origin is initially coincident with the Rover (R) frame and is initially equivalent to the Mars Local Level Frame (M).
- After the Lander petals have been deployed and Rover orientation has been initially estimated (through accelerometer measurements located in the rover IMU and sun search performed by the cameras), this frame is fixed with respect to the Mars Body Fixed Frame (MBF) and is no longer assumed coincident with the R frame or equivalent to the M frame. The initial S frame shall be fixed thereafter.
- $Z_S \equiv$ unit vector that is normal to the Mars IAU^[i] Reference Ellipsoid, which originates at the Lander (L) origin at the time of or immediately prior to the Sun search, and which points down into the Ellipsoid. This is the Nadir vector.
- $X_S \equiv$ unit vector that points toward the North Spin Axis, that lies in the plane tangent to the reference ellipsoid, and which originates as given above in the Z_S definition.
- $Y_S \equiv$ unit vector that is orthogonal to X and Z that completes a right hand coordinate frame. In addition, this originates as given above in the Z_S definition. This is the Nominal East Vector.

^[i] “Report of the IAU/IAG/COSPAR Working Group on Cartographic Coordinates and Rotational Elements of Planets and Satellites: 1994”; M. Davies et al.; published in Celestial Mechanics.

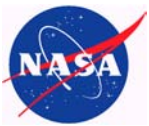

Coordinate Frames



Mars Exploration Rover

The Pancams and Navcams can be pointing in the following coordinate frames:

Name	Coordinate Frame	Parameters	Units	Boresight options
Mast Frame az/el	Mast	azimuth,elevation	radians	camera bar
Rover Frame az/el	R (Rover)	azimuth, elevation	radians	camera bar, Mini-TES boresight
Rover Frame point	R (Rover)	x,y,z	meters	left Navcam, right Navcam, left Pancam, right Pancam, camera bar, Mini-TES boresight
Local Level Frame az/el	S _L (Local Level)	azimuth/elevation	radians	camera bar, Mini-TES boresight
Local Level Frame point	S _L (Local Level)	x,y,z	meters	left Navcam, right Navcam, left Pancam, right Pancam, camera bar, Mini-TES boresight
Site Frame point	S _S (site frame)	x,y,z	meters	left Navcam, right Navcam, left Pancam, right Pancam, camera bar, Mini-TES boresight
IVP Object	IVP Object	Object name	none	camera bar

Mini-TES Optics Frame az/el	Mini-TES Optics	azimuth,elevation	radians	Mini-TES boresight
-----------------------------	-----------------	-------------------	---------	--------------------



Multiple Site Frames



Mars Exploration Rover

- MER extends the use of the MPF coordinate systems by including multiple instances of the Surface Fixed frame (S Frame).
- Upon landing (and before Rover egress), the origin of the first instance of the S Frame (S_0) is coincident with the origin of the R Frame.
- When the Rover egresses from the lander, the S_0 Frame stays fixed in space, the L Frame stays attached to the lander (in both position and orientation), and the Local Level and R Frame origins move with the Rover.
- The positional offset between the S_0 and R Frames is simply the location of the Rover in the S_0 Frame.



Multiple Site Frames (cont.)



Mars Exploration Rover

- As the Rover traverses across the surface, it accumulates an error of its position and orientation in the S_0 Frame.
- The error in orientation is periodically corrected by measurements of the position of the Sun at a known time.
- The error in position is corrected by examining images from the surface navigation cameras and comparing the locations of objects that are also contained within images acquired before the traverse. These corrections (position updates) are uplinked to the Rover.



Multiple Site Frames (cont.)



Mars Exploration Rover

- In the simplest case, an entire surface mission could be conducted using one instance of the S Frame.
- Pathfinder used this approach because the lander camera was essentially fixed to the S_0 frame origin (the lander didn't move).
- For MER however, the cameras will regularly move relative to the S Frame origin - and the knowledge of Rover absolute position (relative to the local S Frame) degrades over time.
- Because of this degradation in position knowledge, the image data acquired over time become misaligned.



Multiple Site Frames (cont.)



Mars Exploration Rover

- To prevent the accumulated Rover positional error from propagating into the image data, the Surface frame is “zeroed out” (reset) at strategic locations (defined as a new *site*) during the mission by the Surface operations team (nominally just prior to the acquisition of a large image data set, e.g., a panorama).
- As with all new S Frames, the origin initially coincides with the R Frame origin, and the orientation is aligned with the Local Level (S_L) orientation.
- This new S Frame becomes the operational coordinate system for activities within that site.



Multiple Site Frames



Mars Exploration Rover

Use of telemetry tags for Rover site allows easy downlink, identification, and processing of instrument data for operations.

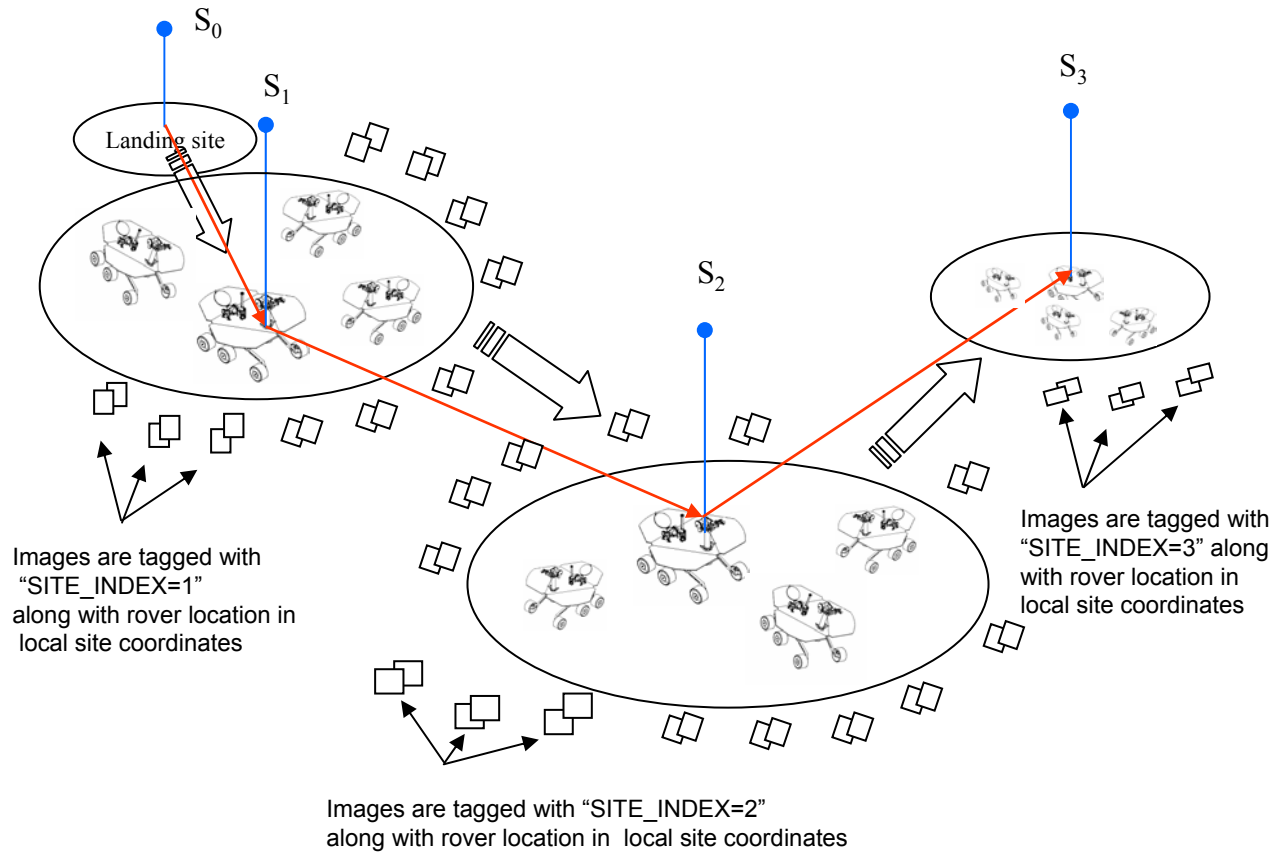



Positions within a single site frame



Mars Exploration Rover

Use of telemetry tags for Rover position allows easy downlink, identification, and processing of instrument data for operations. Example: mosaics assembled from image data acquired at the same site, position index.

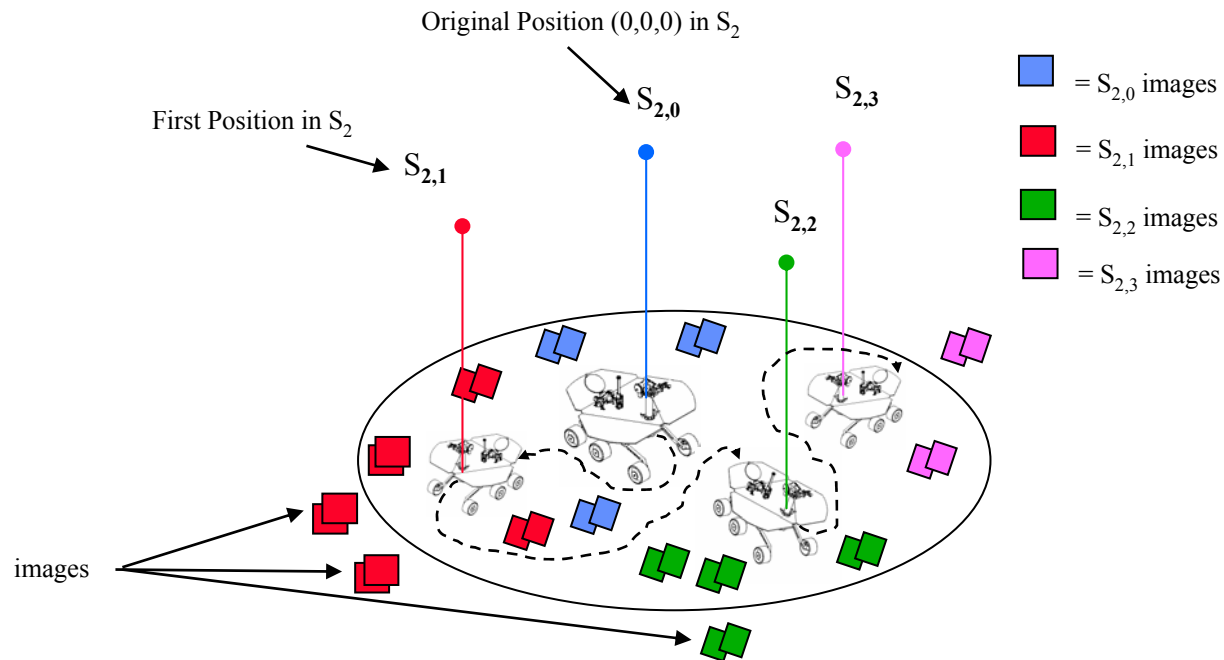

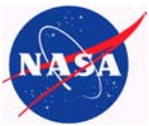

Data Organization for Operations



Mars Exploration Rover

Use of telemetry site/position tags allows the a priori spatial organization of data without relying on the specific xyz Rover position values. This structure provides a systematic method for building and maintaining traversal trees across the entire instrument data set.

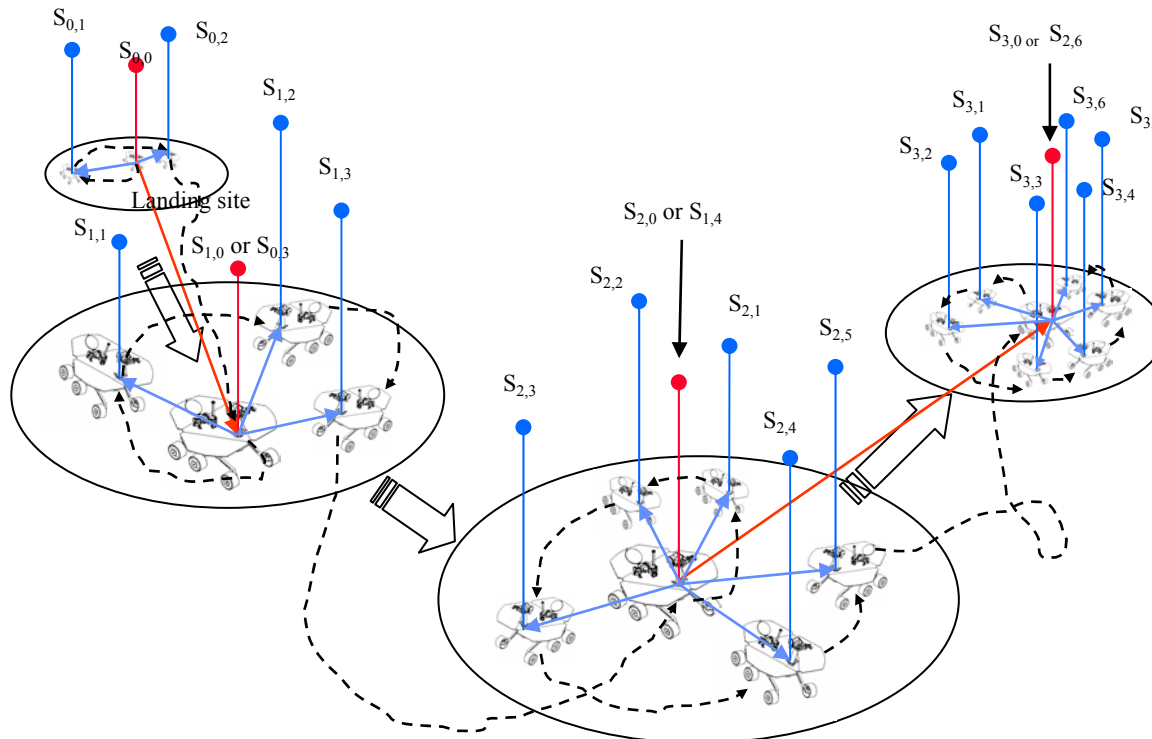



Resetting the Site Frame



Mars Exploration Rover

- As the rover traverses across the Martian surface, the surface coordinate frame will be periodically reset to zero (typically immediately before acquisition of a panorama).
- All of the images and XYZ maps for that site will be in the (same) local site frame.
- The images will be marked with corresponding site index (first component of the rover motion counter).



- The RMC is a monotonically increasing counter – as the rover moves around on the surface, the RMC increments.
- The RMC is composed of five integers (or index values):
 - the *site index* - incremented by ground command
 - the *drive index* - incremented after the completion of a low-level drive primitive (move, arc turn, etc.)
 - the *IDD index* - incremented after the completion of a low-level IDD primitive (movement of IDD joint)
 - the *PMA index* - incremented after the completion of a low-level PMA primitive (movement of PMA)
 - the *HGA index* - incremented after the completion of a low-level HGA primitive (movement of HGA)
- The RMC serves as a compact/efficient notation for referencing the rover position/state during a traverse or activity.
- The RMC is placed in the headers of instrument data products.

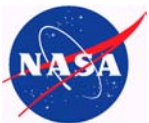

MER Data Product Organization Tags: Rover Motion Counter (cont.)



Mars Exploration Rover

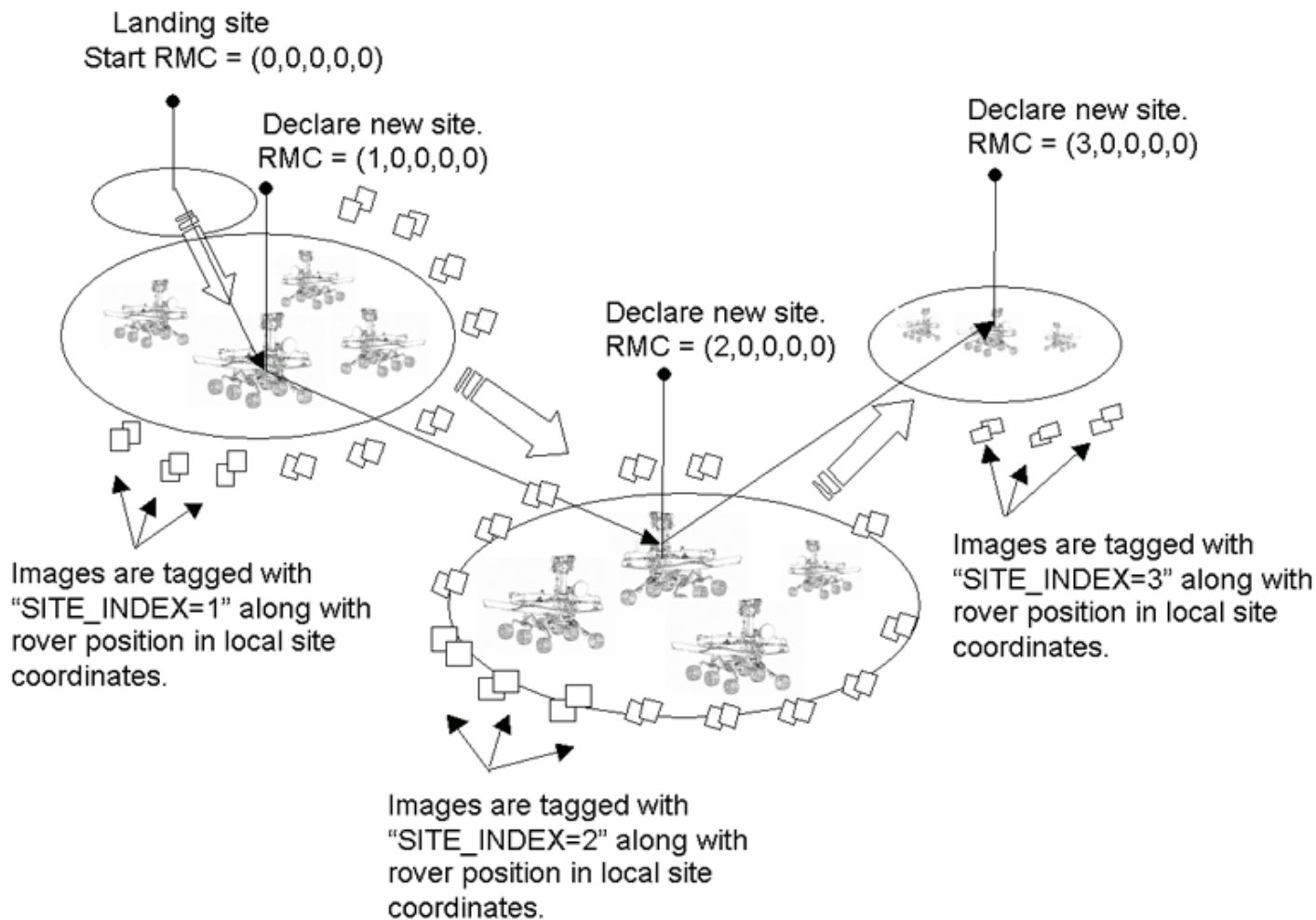



- The RMC tracks the movement of the rover within a site.
- As the rover drives from one position to the next, the drive index (second component of the RMC) is incremented.
- When the Instrument Deployment Device (IDD) is in use, the IDD index (third component of the RMC) is incremented.
- The RMC is returned with all instrument data and provides a useful way to associate data sets across multiple instruments and multiple Sols of operation.

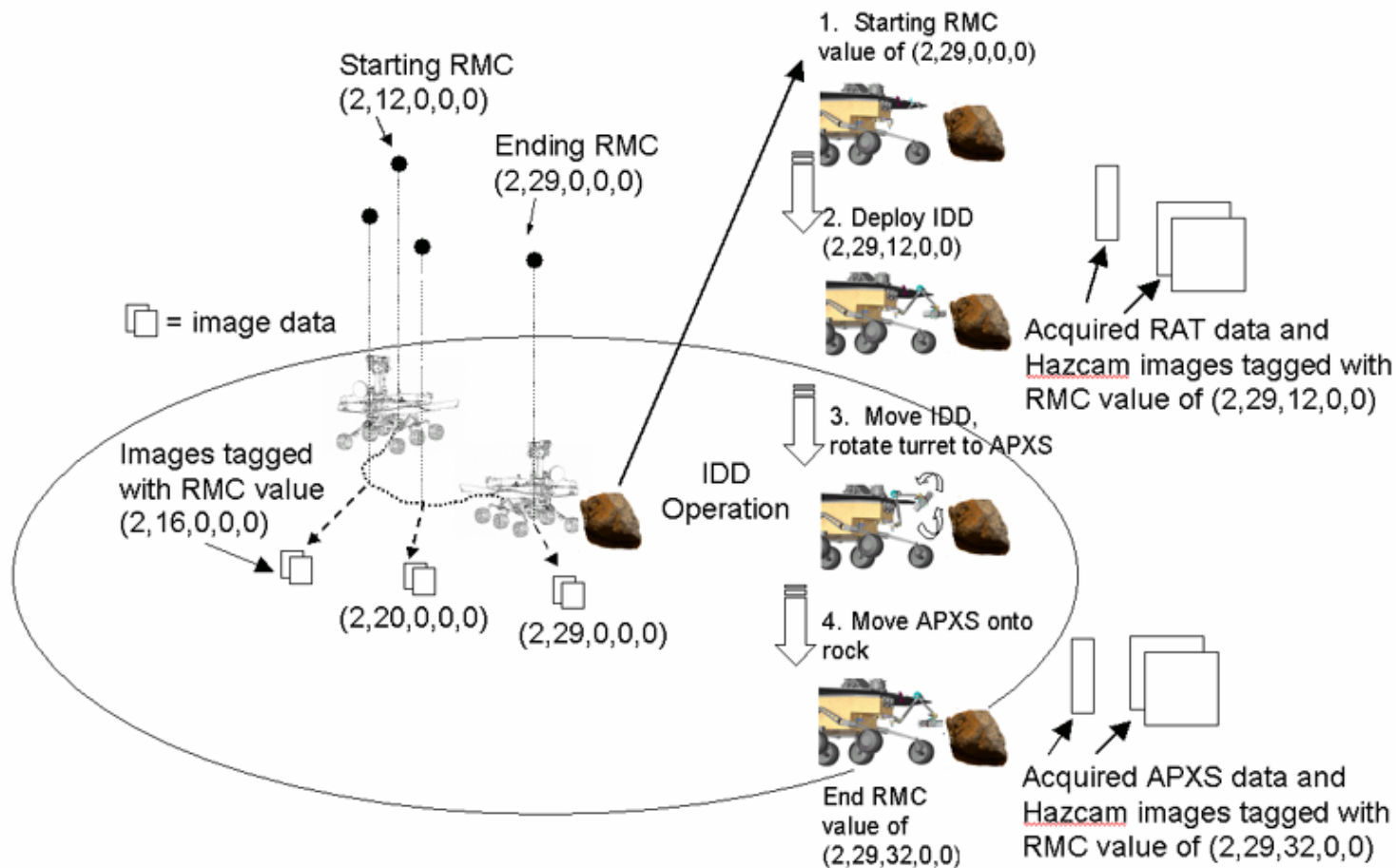



Rover Motion Counter Example



Mars Exploration Rover

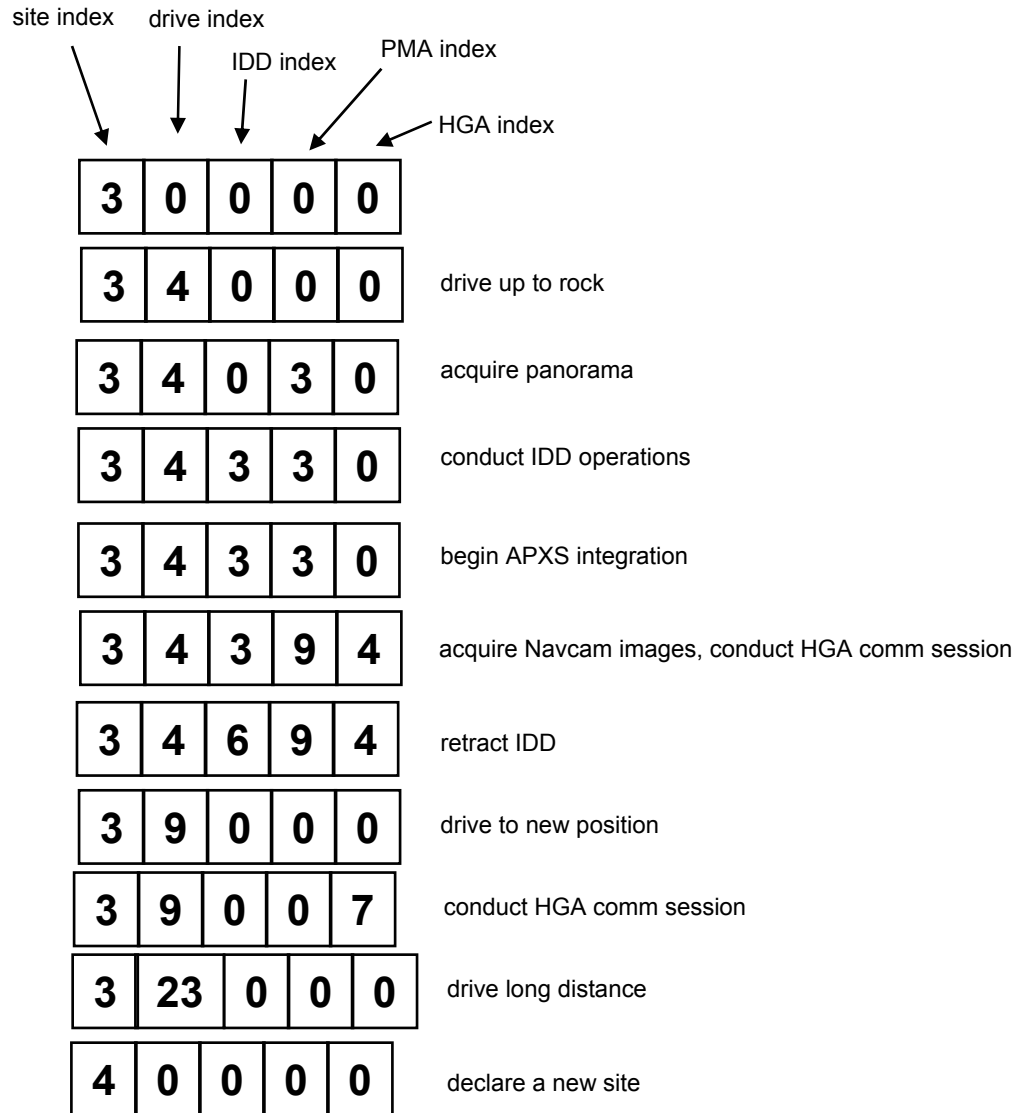



- Context ID (CID)
- The 5-digit CID is used to identify the context from which a data product was acquired.
- The context ID is settable via the `set_context_id()` ground command.
 - [SET_MSTR_ID](#)
 - [SET_SUBMSTR2_ID](#)
 - [SET_SUBMSTR1_ID](#)
- The context ID is placed into the data product headers.
- The context ID itself can map across sequences and/or sols.
- The actual convention/use of the context ID is being worked out during PORT testing.

Example 1: Pancam panorama:

```
set_submstr1_id = 10200 (Pancam stereo panorama at blue dune)
capture_image(...)...
capture_image(...)...
capture_image(...)...
```

Every image in the Pancam panorama will be tagged with context ID 10200

Example 2: Targeted Observations of the rock named “schnitzel”

```
set_submstr1_id = 00423 (IPS assault on schnitzel)
acquire APXS, Mossbauer, MI and RAT data
acquire Pancam multispectral images
acquire Hazcam IDD support images
```

Every data product associated with the schnitzel observation will be tagged with context ID 00423

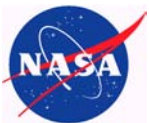

- **The following data tags will be used for MER data organization:**

Name	Range	Comment
Sol	0-90...	Computed from SCLK/DVT
Context ID	0-65535	Set by ground commands
Rover Motion Counter	Site Index (0-65535) Drive Index (0-65535) IDD Index (0-65535) PMA Index (0-65535) HGA Index (0-65535)	With the exception of the site index, all elements of the RMC are automatically generated.
Sequence ID	0000-9999	Determined via product ID
Sequence Version	A-Z	Determined via product ID