

Mars Exploration Rover (MER)

Software Interface Specification

Interface Title: **Camera Experiment Data Record (EDR) and
Reduced Data Record (RDR) Operations and
Science Data Products**

Mission: MER Date: September 25, 2007

Module ID: SIS-SCI006-MER

Module Type (REFerence Only or MISsion-specific info included): MIS

Reference Module ID: N/A

Date: N/A

Signatures

GDS Generating Elements:

Ops Product Generation Subsystem (OPGS)
Justin Maki

Subsystem Engineer

Date

Science Receiving Elements:

MER Science Manager
John Callas

Manager

Date

Concurrence:

Pancam Payload Element Lead
Jim Bell

PEL

Date

Microscopic Imager Payload Element Lead
Ken Herkenhoff

PEL

Date

RSVP Development Team
Brian Cooper

Cognizant Engineer

Date

SAP Development Team
Jeff Norris

Cognizant Engineer

Date

PDS Project Manager
Laverne Hall

Manager

Date

PDS Discipline Node Manager
Sue Lavoie

Manager

Date

MIPL Cognizant Engineer
Doug Alexander

Cognizant Engineer

Date

Mars Exploration Rover Project

Software Interface Specification (SIS)

Camera

Experiment Data Record (EDR) and Reduced Data Record (RDR) Operations and Science Data Products

Version 4.0

Custodians:

Doug Alexander, Bob Deen

Paper copies of this document may not be current and should not be relied on for official purposes. The current version is in DocuShare at <http://mars03-lib.jpl.nasa.gov/mars03-lib/dscgi/ds.py/View/Collection-3903>.

JPL D-22846

September 25, 2007



Jet Propulsion Laboratory
California Institute of Technology

CHANGE LOG

DATE	SECTIONS CHANGED	REASON FOR CHANGE	REVISION
2/11/03	<u>Appendices A & B</u> <ul style="list-style-type: none"> In Telemproc code, add generation of new keyword called RELEASE_ID. Set default value to be "0001". 	PDS has decreed it (needed for archival tracking).	Version 2.0
2/12/03	<u>Table 2.4.1</u> <ul style="list-style-type: none"> Added Angular Resolution spec. 	Useful for calculations.	Version 2.0
2/12/03	<u>Section 2.5</u> <ul style="list-style-type: none"> Added this subsection to cover the EDLcam descriptions. 	Needed to be added.	Version 2.0
2/12/03	<u>Section 4.4.1</u> <ul style="list-style-type: none"> Changed definition of field "seq" in filename to include character at 1st position in field. 	Correction.	Version 2.0
2/18/03	<u>Section 4.4.2</u> <ul style="list-style-type: none"> Changed Vertical projection identifier from "VER" to "VRT". 	Changed to match MIPL legacy.	Version 2.0
3/3/03	<u>Table 2.1.2</u> <ul style="list-style-type: none"> Modified wavelength and bandpass values per Jim Bell request. 	Based on newer data.	Version 2.0
3/3/03	<u>Appendices A & B</u> <ul style="list-style-type: none"> Deleted PRODUCER_ID from label. Changed format of INVALID_CONSTANT and MISSING_CONSTANT to float. Added INTERCHANGE_FORMAT to Object IMAGE and modified valid value list. Added BAND_STORAGE_TYPE to Object IMAGE and added definition and valid value list from PDS. Quoted all UTC formatted time values in Appendix A. Changed default value for PRODUCER_ID to "MIPL". Change case of leading character in value for SEQUENCE_ID to lowercase in Appendix A, reflecting true format. 	Correction.	Version 2.0
3/6/03	<u>Section 4.4.1 & Section 4.4.2</u> <ul style="list-style-type: none"> Modified descriptions for Site and Pos fields in filename to denote valid range of 0-1296 by mixing integers and alphas. 	Correction.	Version 2.0
3/7/03	<u>Section 5.2.8</u> <ul style="list-style-type: none"> Added this section to describe the Surface Normal Calculation RDR. 	New.	Version 2.0
3/7/03	<u>Appendix A</u> <ul style="list-style-type: none"> Added column for Surface Normal RDRs. 	New.	Version 2.0
3/20/03	<u>Appendix B</u> <ul style="list-style-type: none"> For PRODUCT_VERSION_ID, changed string length from 10 to 12. For MAP_PROJECTION_TYPE, added valid value "ORTHOGRAPHIC". 	Correction.	Version 2.0

DATE	SECTIONS CHANGED	REASON FOR CHANGE	REVISION
4/17/03	<ul style="list-style-type: none"> • Add values for IMAGE_TYPE. <u>Appendices A & B</u> <ul style="list-style-type: none"> • Added keyword INST_CMPRS_SEGMENT_QUALITY. • Added keyword INST_CMPRS_SEG_MISSING_PIXELS. 	New	Version 2.1
4/17/03	<u>Appendices A & B</u> <ul style="list-style-type: none"> • Added LOCO compression case for INST_CMPRS_DESC, INST_CMPRS_NAME, INST_CMPRS_FILTER, INST_DECOMPS_STAGES, APPLICATION_PROCESS_SUBTYPE_ID. 	Needed to support LOCO compression.	Version 2.1
4/17/03	<u>Appendix B</u> <ul style="list-style-type: none"> • Added valid values for “simulated” MER-1 and MER-2 for DATA_SET_ID, DATA_SET_NAME, INSTRUMENT_HOST_ID, INSTRUMENT_HOST_NAME. 	Needed to support “simulated” spacecraft i.d.’s.	Version 2.1
4/17/03	<u>Section 4.4.1</u> <ul style="list-style-type: none"> • Added JPEG values for filename “Extension” field. 	Needed to support SAP request to deliver JPEG and scaling capabilities.	Version 2.1
4/17/03	<u>Sections 4.4.1 & 4.4.2</u> <ul style="list-style-type: none"> • Added valid values “3” and “4” to Rover I.D. field of filename nomenclature. 	Needed to support “simulated” spacecraft i.d.’s.	Version 2.1
4/17/03	<u>Sections 4.4.1 & 4.4.2</u> <ul style="list-style-type: none"> • Of the EDR 3-char Product Types, changed “EDR” to “EFF”. • Of the RDR 3-char Product Types, added/changed several (see “Product Type” field’s table). 	Needed to identify Thumbnail-sized RDRs. As contingency when larger frames are not downlinked, Thumbnails will provide source for traverse planning in ops.	Version 2.1
10/18/03	<u>Section 4.4.1</u> <ul style="list-style-type: none"> • Modified examples, some wording. 	Clarity	Version 2.1
10/25/03	<u>Section 4.4.2</u> <ul style="list-style-type: none"> • Changed Mosaic RDR filename convention. 	Per Jim Bell's request to include Seq ID. Make more efficient use of 27.3 nomenclature.	Version 2.1
11/1/03	<u>Section 4.4.3</u> <ul style="list-style-type: none"> • Added Terrain Mesh RDR filename convention. 	New	Version 2.1
11/6/03	<u>Appendix B</u> <ul style="list-style-type: none"> • Added CONFIGURATION_BAND_ID and INSTRUMENT_BAND_ID. 	New	Version 2.1
11/12/03	<u>Appendix B</u> <ul style="list-style-type: none"> • Added new wording to several keyword definitions and/or valid values, reflected in BLUE. 	Clarity and accuracy	Version 2.1

DATE	SECTIONS CHANGED	REASON FOR CHANGE	REVISION
11/18/03	<u>Sections 5.2.6, 5.2.7, 5.2.8</u> <ul style="list-style-type: none"> Added descriptive text for IDD Reachability, Surface Normal and Surface Roughness RDRs. 	New	Version 2.1
11/22/03	<u>Section 5.2.1</u> <ul style="list-style-type: none"> Added text from Jim Bell to describe 3 Pancam radiometrically-corrected products. 	New	Version 2.1
12/2/03	<u>Appendix B</u> <ul style="list-style-type: none"> Added new wording to several keyword definitions and/or valid values, reflected in BLUE. <u>Section 5.2.1</u> <ul style="list-style-type: none"> Added this new section of ILUT Ops product types. <u>Appendix C</u> Added new wording to several keyword definitions and/or valid values, reflected in BLUE.	Clarity and accuracy	Version 2.1
6/22/04	<u>Section 5.2.9</u> <ul style="list-style-type: none"> Added this new section describing Slope RDR. <u>Section 4.4</u> <ul style="list-style-type: none"> Added Slope RDR product identifier. 	New	Version 3.0
6/25/04	<u>Section 5.2.13</u> Added this new section describing Anaglyph RDR. <u>Appendix D</u> <ul style="list-style-type: none"> Added this new appendix showing Responsivity coefficients. 	New	Version 3.0
6/26/04	<u>Section 5.2.13</u> <ul style="list-style-type: none"> Added this new section describing Anaglyph RDR. 	New	Version 3.0
6/27/04	<u>Section 5.2.2.3</u> <ul style="list-style-type: none"> Added more text describing details of MIPLRAD rad-correction process. 	Requested by J. Bell (Pancam Team).	Version 3.0
6/30/04	<u>Section 5.2.12</u> <ul style="list-style-type: none"> Added more text describing details of MIPL mosaicking process. 	Requested by J. Bell (Pancam Team) and MI Team (USGS).	Version 3.0
7/22/04	<u>Appendix A</u> <ul style="list-style-type: none"> Fixed quoting syntax to be compliant with PDS standards. 	Noticed and requested by USGS.	Version 3.0
7/22/04	<u>Section 5.2.2.2</u> <ul style="list-style-type: none"> Added this new section that describes the MI Team's rad-corrected products. 	New	Version 3.0
7/25/04	<u>Appendix B</u> <ul style="list-style-type: none"> Added 21 new keywords received from Pancam Team. 	Keywords apply to Pancam Science product.	Version 3.0
7/26/04	<u>Appendix A</u> <ul style="list-style-type: none"> Added 21 new keywords received from Pancam Team. 	Keywords apply to Pancam Science product.	Version 3.0
12/1/04	<u>Appendix B</u> <ul style="list-style-type: none"> Added keyword MOSAIC_DESC. 	New, to supplement descriptions of Mosaic RDRs.	Version 4.0
12/1/04	<u>Section 5.2.2.2</u>	New	Version 4.0

DATE	SECTIONS CHANGED	REASON FOR CHANGE	REVISION
	<ul style="list-style-type: none"> Added text for MI instrument "RAD" filetype, as written by Ken Herkenhoff. 		
12/1/04	<u>Section 4.4</u> <ul style="list-style-type: none"> Added 3-char prod type identifiers into tables for new RDRs: Slope Rover Direction, Slope Heading, Slope Magnitude, Solar Energy 	New	Version 4.0
2/9/05	<u>Appendix B</u> <ul style="list-style-type: none"> Changed definition for INST_CMPRS_MODE. Changed definition for INST_CMPRS_SEGMENT_QUALITY. 	Incorrect definitions.	Version 4.0
3/15/05	<u>Signature Cover Sheet</u> <ul style="list-style-type: none"> Arthur Amador, Deborah Bass and Frank Singleton have been removed as signatories for this document. 	Named individuals have left the MER project.	Version 4.0
3/27/05	<u>Section 5.2.2.2</u> <ul style="list-style-type: none"> Changed text from "W/m²/sr" to "W/m²/nm/sr" per request from Ken Herkenhoff. 	Incorrect units.	Version 4.0
3/22/07	<u>Appendix B</u> <ul style="list-style-type: none"> Corrected valid values for EXPOSURE_DURATION 	Fix	Version 4.1
9/25/07	<u>Section 4.4.3</u> <ul style="list-style-type: none"> Added character "O" as valid value for INST field in Terrain Mesh filename 	New	Version 4.1

OPEN ACTION ITEMS

ITEM	ASSIGNEE

TABLE OF CONTENTS

Change Log.....	i
Open Action Items for Closure.....	iii
List of Figures.....	vi
List of Tables	vi
Acronyms and Abbreviations	vii
Glossary.....	ix
1. INTRODUCTION.....	1
1.1 Purpose and Scope.....	1
1.2 Contents	1
1.3 Constraints and Applicable Documents	1
1.3.1 Relationships with Other Interfaces.....	3
2. INSTRUMENT OVERVIEW.....	5
2.1 Panoramic Camera (Pancam)	6
2.2 Navigation Camera (Navcam)	7
2.3 Hazard Avoidance Camera (Hazcam)	7
2.4 Microscopic Imager (MI)	8
2.5 Descent Camera (Descam)	9
3. DATA PROCESSING OVERVIEW.....	10
3.1 Data Processing Level	10
3.2 Data Generation	11
3.2.1 EDR Data Product.....	11
3.2.1.1 Operations EDR.....	11
3.2.1.1.1 Data Flow	11
3.2.1.1.2 Data Format	11
3.2.1.2 Science EDR	12
3.2.1.2.1 Data Flow	12
3.2.1.2.2 Data Format	12
3.2.2 RDR Data Product.....	13
3.3 Data Validation	13
4. DATA PRODUCT OVERVIEW.....	14
4.1 Data Product Structure	14
4.2 Label and Header Descriptions	16
4.2.1 PDS Label.....	16
4.2.1.1 PDS Image Object	16
4.2.1.2 Keyword Length Limits	17
4.2.1.3 Data Type Restrictions.....	17
4.2.1.4 Interpretation of N/A, UNK, and NULL	17
4.2.1.5 PDS Label Constructs “Class”, “Object” and “Group”	18
4.2.2 VICAR Label.....	19
4.2.3 Mapping of PDS and VICAR Labels	20
4.3 Binary Data Storage Conventions	21
4.3.1 Bit and Byte Ordering.....	21
4.4 File Naming	22
4.4.1 EDR and Single-frame RDR.....	22
4.4.2 Mosaic RDR.....	28

4.4.3 Terrain Mesh RDR	33
5. DETAILED DATA PRODUCT SPECIFICATIONS	35
5.1 EDR Data Products	35
5.1.1 Full Frame EDR	36
5.1.2 Thumbnail EDR	36
5.1.3 Sub-frame EDR	36
5.1.4 Downsampled EDR	36
5.1.5 Row Summation EDR	37
5.1.6 Column Summation EDR	37
5.1.7 Reference Pixels	37
5.1.8 Histogram EDR	37
5.2 RDR Data Products	38
5.2.1 Inverse LUT RDR	39
5.2.2 Radiometrically Corrected RDR	39
5.2.2.1 PANCAL Method.....	39
5.2.2.2 MICAL Method.....	40
5.2.2.3 MIPLRAD Method	40
5.2.3 CAHV Linearized RDR	43
5.2.4 XYZ RDR	44
5.2.4.1 XYZ Rover Volume Exclusion Mask	44
5.2.5 Range RDR	44
5.2.6 Disparity RDR	45
5.2.7 Surface Normal (UVW) RDR	45
5.2.8 Surface Roughness RDR	45
5.2.9 Slope RDR	46
5.2.10 IDD Reachability RDR	46
5.2.11 Terrain Map RDR	47
5.2.11.1 VST Terrain Wedge	47
5.2.11.2 PFB Terrain Mesh	47
5.2.12 Mosaic RDR	47
5.2.12.1 Overview of Mosaics in General	47
5.2.12.2 How MIPL Creates Mosaics	48
5.2.12.3 Cylindrical Projection Mosaic.....	50
5.2.12.4 Camera Point Perspective Mosaic.....	50
5.2.12.5 Cylindrical- Perspective Projection Mosaic.....	51
5.2.12.6 Polar Projection Mosaic.....	53
5.2.12.7 Vertical Projection Mosaic	54
5.2.12.8 Orthographic Projection Mosaic.....	54
5.2.12.9 XYZ Mosaic	55
5.2.12.10 Surface Normal (UVW) Mosaic.....	55
5.2.13 Anaglyph RDR	55
6. STANDARDS USED IN GENERATING PRODUCTS	57
6.1 PDS Standards	57
6.2 Time Standards	57
6.3 Coordinate Frame Standards	57
7. APPLICABLE SOFTWARE	59
7.1 Utility Programs	59
7.2 Applicable PDS Software Tools	61
7.3 Software Distribution and Update Procedures	61

APPENDICES

A	Camera “Combined” EDR/RDR Label.....	62
B	Camera EDR & RDR Label Keyword Definitions	74
C	“12 to 8-bit” Inverse Lookup Tables (ILUTs)	150
D	Radiometric Correction Files & Parameters.....	156

LIST OF FIGURES

Figure 2 - MER Camera Payload Configuration	5
Figure 4 - Acquisition and Readout of Full Frame Pre-Flight EDR Using GSE	14
Figure 4.1.1 - EDR Structures	15
Figure 4.1.2 - RDR Structures	15
Figure 5.2.11.1 – Cylindrical Projection Mosaic.....	50
Figure 5.2.11.2 – Camera Point Perspective Mosaic.....	51
Figure 5.2.11.3 – Cylindrical-Perspective Projection Mosaic	52
Figure 5.2.11.4 – Polar Projection Mosaic.....	53
Figure 5.2.11.5 – Vertical Projection Mosaic	54
Figure 6.3 - S, S _R and R Coordinate Frames.....	58

LIST OF TABLES

Table 1.4 Product and Software Interfaces to this SIS.....	3
Table 2 - Tabulation of MER Cameras per Rover.....	5
Table 2.1.1 - Pancam Optics Characteristics	6
Table 2.1.2 - Pancam Spectral Filters	6
Table 2.2 - Navcam Optics Characteristics	7
Table 2.3 - Hazcam Optics Characteristics	7
Table 2.4.1 - MI Optics Characteristics	8
Table 2.4.2 - MI Spectral Filters.....	8
Table 2.5 – Descent Camera Optics Characteristics	9
Table 3.1 - Processing Levels for Science Data Sets	10
Table 4.2.3 - PDS Class to VICAR Property Set Mappings	20
Table 4.3.1 - MER Camera EDR and RDR Bit Ordering.....	22
Table 5.1 - MER Camera EDR Data Products	35
Table 5.2 - MER Camera RDR Data Products	38
Table 5.2.2.2 – Temperature Responsivity Priority by Instrument.....	42
Table 6.3 - Coordinate Frames Used for MER Surface Operations	57
Table 7.1 - Key Software Tools for MER Camera Payload Downlink Processing	59

ACRONYMS AND ABBREVIATIONS

ASCII	American Standard Code for Information Interchange
APSS	Activity Planning and Sequencing Subsystem
CCD	Charged Coupled Device
EDL	Entry, Descent and Landing
Descam	Descent Camera
EDR	Experiment Data Record
FEI	File Exchange Interface
FSW	Flight Software
GDS	Ground Data System
GSE	Ground Support Equipment
Hazcam	Hazard Avoidance Camera
ICER	Image compression algorithm (not an acronym)
ID	Identification
IDD	Instrument Deployment Device
ISIS	Integrated Software for Imagers and Spectrometers
IVP	Inertial Vector Propagation
JPL	Jet Propulsion Laboratory
LOCO	LOW-COMplexity, LOSSless COmpression
MPF	Mars Pathfinder
MER	Mars Exploration Rover
MI	Microscopic Imager
MIPL	Multimission Image Processing Laboratory
NASA	National Aeronautics and Space Administration
Navcam	Navigation Camera
ODL	Object Description Language
OPGS	Operations Product Generation Subsystem
OSS	Operations Storage Server
Pancam	Panoramic Camera
PDS	Planetary Data System
PMA	Pancam Mast Assembly
RDR	Reduced Data Record
RSVP	Rover Sequencing and Visualization Program
SAP	Science Activity Planner
SCLK	Spacecraft Clock
SCM	Spacecraft Configuration Manager
SFDU	Standard Format Data Unit

SIS	Software Interface Specification
SOAS	Science Operations Analysis Software
SOST	Science Operations Support Team
SOWG	Science Operations Working Group
SPICE	Spacecraft, Planet, Instrument, C-matrix, Events kernels
SSV	Solar System Visualization group
TBD	To Be Determined
TDS	Telemetry Delivery Subsystem
USGS	United States Geological Survey
VICAR	Video Image Communication and Retrieval
VPP	Visualization Products Pipeline
WEB	Warm Electronics Box

GLOSSARY

TERM	DEFINITION

1. INTRODUCTION

1.1 Purpose and Scope

The purpose of this Data Product Software Interface Specification (SIS) is to provide consumers of MER Camera Payload Experiment Data Record (EDR) and Reduced Data Record (RDR) operations data products with a detailed description of the products and how they are generated, including data sources and destinations. The users for whom this SIS is intended include the Operations Product Generation Subsystem (OPGS), Activity Planning and Sequencing Subsystem (APSS), users and developers of Science Operations Analysis Software (SOAS), and the scientists who will analyze the data, including those associated with the MER Project and those in the general planetary science community.

Throughout this document, “MER Camera Payload” refers to the suite of five MER imaging instruments: 1) Panoramic Camera (Pancam), 2) Navigation Camera (Navcam), 3) Hazard Avoidance Camera (Hazcam), 4) Microscopic Imager (MI) and 5) Descent Camera (Descam). The main differences between the five instruments are in the optics, mounted positions, and articulation methods. Descam is characterized by radiometric properties that differ from those of the four other cameras due to a difference in the gain. All cameras share the same electronics design and spacecraft interfaces.

The EDR data product is the raw, uncalibrated, uncorrected image data acquired by the MER Camera Payload instrument. The full frame EDR data product for each camera instrument is identical in format, except for some product label differences. For this reason, the full frame EDR data products will be discussed in terms of a singular “EDR data product” throughout the remainder of this document.

The terms “Operations EDR” and “Science EDR” are used throughout this document to account for two methods of ground processing when onboard “12 to 8-bit” scaling is commanded. Both characterize the EDR data product as described above, differing in application and the manner by which “12 to 8-bit” scaled data is stored in the product. Their descriptions are detailed in Section 3.3.1.

The RDR data product is derived directly from one or more EDR or RDR data products, and is comprised of radiometrically decalibrated and/or camera model corrected and/or geometrically altered versions of the raw camera data.

1.2 Contents

This Data Product SIS describes how the EDR data product is acquired by the camera and how it is processed, formatted, labeled, and uniquely identified, and how the RDR data product is derived from EDR or RDR data products. The document discusses standards used in generating the product and software that may be used to access the product. The EDR and RDR data product structure and organization is described in sufficient detail to enable a user to read the product. Finally, examples of composite EDR/RDR labels are provided, along with the definitions of the keywords in the label.

1.3 Constraints and Applicable Documents

This SIS is meant to be consistent with the contract negotiated between the MER Project and the four MER Camera Payload Principal Investigators (PI) in which reduced data records and documentation are explicitly defined as deliverable products. Because this SIS governs the specification of camera-related products used during operations, any proposed changes to this SIS must be impacted by all affected software subsystems observing this SIS in support of operations (e.g., APSS, OPGS, SOAS).

Secondly, keywords may be added to future revisions of this SIS. Therefore, it is recommended that software designed to process EDRs and RDRs specified by this SIS should be robust to (new) unrecognized keywords.

Additionally, this Data Product SIS is responsive to the following MER documents:

1. Mars Exploration Program Data Management Plan, R. E. Arvidson and S. Slavney, Rev. 2, Nov. 2, 2000.
2. Mars Exploration Rover Project Archive Generation, Validation and Transfer Plan, R. E. Arvidson and S. Slavney, JPL D-19658, January 2, 2001.
3. MER Functional Design Description (FDD), "Volume 28: Pancam Mast Assembly (PMA)", JPL D-22379, MER 420-8-534.28, February 13, 2002, "Volume 30: Imaging", JPL D-22130, MER 420-8-534.30, February 13, 2002.

Additionally, this SIS is also consistent with the following Planetary Data System documents:

4. Planetary Data System Data Preparation Workbook, JPL D-7669, Version 3.1, Part 1, February 1, 1995.
5. Planetary Data System Data Standards Reference, JPL D-7669, Version 3.3, Part 2, June 1, 1999.

Finally, this SIS makes reference to the following documents for technical background information:

6. Pointing, Positioning, Phasing & Coordinate Systems Master (PPPCS), S.R. Doudrick, JPL D-19720, June 28, 2001.
7. MER Flight–Mission Systems Interface Control Document (ICD), "Volume 7, Telemetry Dictionary", K. Spellman, JPL D-20618, MER 420-1-333, March 3, 2003.
8. Mars Exploration Rover Science and Engineering CCD Cameras IICD Rev. A, D. Herman, JPL D-20257, February 14, 2002.
9. Mars Exploration Rover Project Athena Science Implementation Plan, S. Squyres, JPL D-20458, Version 1.1, May 31, 2001.
10. Mars Exploration Rover Mission System Software Implementation Notes Operations Product Generation Subsystem (OPGS), H. Mortensen, JPL D-22102, MER 420-1-311.15, February 11, 2002.
11. Mars Exploration Rover Project APXS EDR SIS, S. Slavney and H. Mortensen, JPL D-22848, November 3, 2003.
12. Mars Exploration Rover Project Mössbauer EDR SIS, S. Slavney and H. Mortensen, JPL D-22849, November 6, 2003.
13. Mars Exploration Rover Project Image Processing Architecture, Requirements and Interfaces Document, J. Maki, JPL D-20049, December 15, 2000.
14. Pancam Calibration Report, JPL D-19826, MER 420-6-700, 2003.
15. The Mars Exploration Rover Athena Panoramic Camera (Pancam) Investigation, J.F. Bell III et al., *J. Geophys. Res.*, 2003.
16. A System for Extracting Three-Dimensional Measurements from a Stereo Pair of TV Cameras, Y. Yakimovsky and R. Cunningham, January 7, 1977.
17. Camera Calibration, D. Gennery, JPL IOM 347/86/10, February 5, 1986.
18. Sensing and Perception Research for Space Telerobotics at JPL, D. Gennery et al., *Proceedings of the IEEE Intern. Conf. on Robotics and Automation*, March 31 - April 3, 1987.
19. Camera Calibration Including Lens Distortion, D. Gennery, JPL D-8580, May 31, 1991.
20. Algorithm for Using CAHV to Determine SGI Graphics Viewpoint and Perspective, B. Bon, JPL IOM 3472-91-057, August 6, 1991.

21. Inclusion of Old Internal Camera Model in New Calibration, D. Gennery, JPL IOM 386.3-94-001, February 22, 1994.
22. "Least-Squares Camera Calibration Including Lens Distortion and Automatic Editing of Calibration Points", Calibration and Orientation of Cameras in Computer Vision, D. Gennery, ISBN 3-540-65283-3, 2001.
23. Computations for Generalized Camera Model Including Entrance, Part 1 and Part 2, D. Gennery, unpublished, May 23, 2001.
24. Generalized Camera Calibration Including Fish-Eye Lenses, D. Gennery, JPL D- 03-0869, 2002.
25. Issues with Linearization, R. Deen, JPL Docushare Collection 2700, File 75670, 2003.
26. MER Mission Plan, JPL Docushare, File 16319, 2001.
27. MER IMG Flat Field Scaling, J. Maki, JPL Docushare, File 26302, March 15, 2002.
28. Mars Exploration Rover Engineering Cameras, *J. Geophys. Res.*, Maki, J.N., J. F. Bell III, K. E. Herkenhoff, S. W. Squyres, A. Kiely, M. Klimesh, M. Schwochert, T. Litwin, R. Willson, A. Johnson, M. Maimone, E. Baumgartner, A. Collins, M. Wadsworth, S. T. Elliot, A. Dingizian, D. Brown, E. C. Hagerott, L. Scherr, R. Deen, D. Alexander, and J. Lorre., 108(E12), 8071, doi:10.1029/2003JE002077, 2003.
29. Athena Microscopic Imager Investigation, *J. Geophys. Res.*, Herkenhoff, K. E. et al., 108, 8065, doi:10.1029/2003JE002076, 2003.
30. Planetary Science Data Dictionary Document, Rev E, JPL D-7116, August 28, 2002.

1.3.1 Relationships with Other Interfaces

Changes to this EDR/RDR data product SIS document affect the following products, software, and/or documents.

Table 1.4 Product and Software Interfaces to this SIS

Name	Type	Owner
	P = product S = software D = document	
MIPL database schema	P	MIPL (JPL)
MER Camera Payload EDRs <ul style="list-style-type: none"> • Pancam • Navcam • Hazcam • Microscopic Imager 	P	OPGS, MIPL (JPL)
Pancam RDRs	P	OPGS, Pancam Science Team
Navcam RDRs	P	OPGS, Navcam Science Team
Hazcam RDRs	P	OPGS, Hazcam Science Team
Microscopic Imager RDRs	P	OPGS, MI Science Team
MERTELEMPROC	S	MIPL (JPL)
RSVP, SAP	S	APSS (JPL)
SOAS Software <ul style="list-style-type: none"> • PANCAL • PANMAP • PANSPEC 	S	Cornell University
SOAS Software <ul style="list-style-type: none"> • PDS2ISIS (for MI) 	S	USGS (Flagstaff)

Name	Type P = product S = software D = document	Owner
Mars Program Suite <ul style="list-style-type: none"> • MARSCAHV • MARSRAD • MARSJPLSTEREO • MARSCOR3 • MARSXYZ • MARSUWW • MARSRANGE • MARSREACH • MARSROUGH • MARSMAP • MARSMOS • MARSMCAULEY • MARSNAV • MARSTIE • MICA 	S	MIPL (JPL)
Mars Terrain Suite <ul style="list-style-type: none"> • SUMMITT • XYZ2OBJ 	S	APSS (JPL), MIPL (JPL)
VPP	S	SSV (JPL)
Athena Science Implementation Plan	D	Cornell University

2. INSTRUMENT OVERVIEW

The MER Camera Payload on each vehicle is comprised of 9 individual cameras, all of which share the identical electronics design and spacecraft interfaces. The main differences between the cameras are in the optics, mounted position, and articulation methods. All of the cameras are monochromatic except for the Pancam, which contains an 8-position filter wheel (per eye). The camera detectors are 1024 × 1024 pixel CCDs, and the electronics provide 12-bit analog-to-digital conversion.

Of the 9 cameras, there are 4 sets of stereo pairs and one single camera, as listed in Table 2. Camera mounting locations are shown in Figure 2.

Table 2 - Tabulation of MER Cameras per Rover

MER Camera Payload Instrument	Location	Number of Cameras
Panoramic Camera (Pancam)	Stereo pair on Pancam Mast Assembly (PMA)	2
Navigation Camera (Navcam)	Stereo pair on Pancam Mast Assembly (PMA)	2
“Front” Hazard Avoidance Camera (Hazcam)	Stereo pair at front of Warm Electronics Box	2
“Rear” Hazard Avoidance Camera (Hazcam)	Stereo pair at rear of Warm Electronics Box	2
Microscopic Imager (MI)	Instrument Deployment Device (IDD) arm	1
TOTAL		9

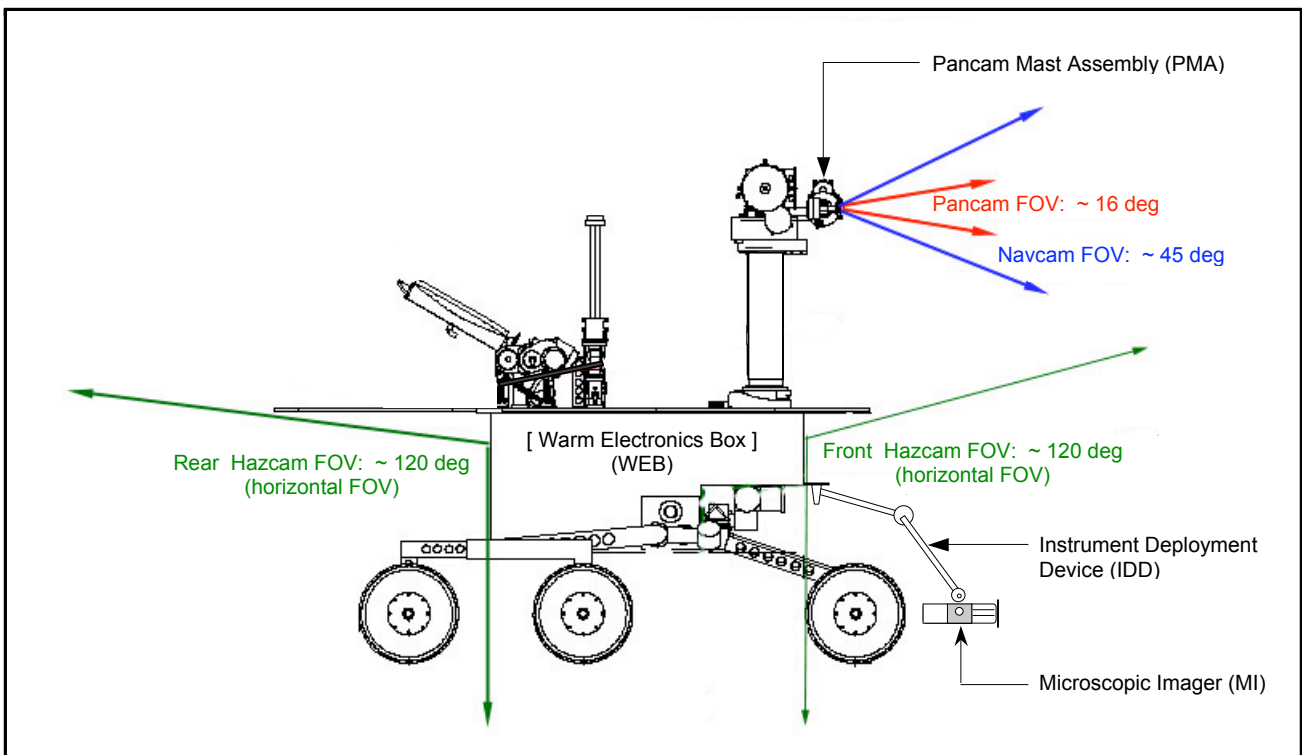

Figure 2 - MER Camera Payload Configuration

Because of the electronics commonality, image data from all cameras are functionally equivalent and are treated identically in Flight Software (FSW) and the Ground Data System (GDS).

The four MER Camera Payload instruments are discussed in general terms in the following subsections. More detailed information describing the individual cameras can be found in the MER Image Processing Architecture, Requirements and Interfaces Document [Ref 13].

2.1 Panoramic Camera (Pancam)

The Pancam is a stereo pair of science cameras at 30 cm baseline separation (1° toe-in) mounted at the top of the Pancam Mast Assembly (PMA) with a range of motion of ±90 degrees of elevation and 360 degrees of azimuth. Narrow-angle optics provide an angular resolution of 0.27 mrad/pixel. The Pancam will be used to image the surface and sky of Mars around the two landing sites. The images will be chosen and used primarily for Science analysis, and also will be used to select desirable targets for composition analysis. Pancam images will also support selection of travel paths for the Rover and development of a landing site map.

Pancam optics characteristics useful in the analysis of EDR and RDR products are described in Table 2.1.1 below:

Table 2.1.1 - Pancam Optics Characteristics

Characteristic	Value
Field of View (FOV)	16 deg x 16 deg
Baseline Stereo Separation	30 cm, 1 deg toe-in
Angular Resolution	0.27 mrad/pixel
Spectral Bandpass	400 – 1100 nm
Number of Spectral Filters	8 per camera

Each Pancam camera has an 8-position filter wheel. Thirteen of the sixteen filters provide color imaging capability in eleven unique wavelengths from 400 to 1100 nm, two of the remaining filters have neutral density coatings to provide direct solar imaging capability in two colors, and one filter wheel position has been left empty to provide for maximum broadband light sensitivity. The spectral bandwidths are described in Table 2.1.2 below:

Table 2.1.2 - Pancam Spectral Filters

Filter Position	Left Eye Wavelength (Bandpass), nm	Right Eye Wavelength (Bandpass), nm	Application
0	NULL or N/A	NULL or N/A	NULL or N/A
1	739 (338) EMPTY	436 (37)	L: EMPTY, R: Blue Stereo
2	753 (20)	754 (20)	Red Stereo
3	673 (16)	803 (20)	Geology
4	601 (17)	864 (17)	Geology
5	535 (20)	904 (26)	Geology
6	482 (30)	934 (25)	Geology
7	432 (32)	1009 (38)	L: Blue Stereo, R: Geology
8	440 (20)	880 (20)	Solar ND5

2.2 Navigation Camera (Navcam)

The Navcam is a mast-mounted stereo pair of engineering cameras at 20 cm baseline separation with a spectral bandpass at approximately 650 nm. It will primarily be used for navigation purposes and general site characterization (360° panoramic images and targeted images of interest, including terrain not viewable by the Hazcams).

The cameras are boresighted with the Pancam, and Navcam images will also be used for Science target selection and analysis.

Navcam optics characteristics useful in the analysis of EDR and RDR products are described in Table 2.2 below:

Table 2.2 - Navcam Optics Characteristics

Characteristic	Value
Field of View (FOV)	45 deg x 45 deg
Baseline Stereo Separation	20 cm
Angular Resolution	0.77 mrad/pixel
Spectral Bandpass	650 nm
Number of Spectral Filters	1 per camera

2.3 Hazard Avoidance Camera (Hazcam)

The Hazcams are two stereo pairs of engineering cameras at 10 cm baseline separation mounted at both the front and rear ends of the Warm Electronics Box (WEB) below the solar panel. Each Hazcam assembly includes 2 cameras with a fixed Red 650 nm bandpass filter (identical to the Navcams).

The Hazcams provide imaging primarily of the near field (< 5m) both in front of and behind the rover. These cameras will be used to determine safe egress directions for the rover and provide for on-board hazard detection using stereo data to build range maps. They also support science operations for selecting near field target and IDD operations.

Hazcam optics characteristics useful in the analysis of EDR and RDR products are described in Table 2.3 below:

Table 2.3 - Hazcam Optics Characteristics

Characteristic	Value
Field of View (FOV)	120 deg x 120 deg
Baseline Stereo Separation	10 cm
Angular Resolution	2.0 mrad/pixel
Spectral Bandpass	650 nm
Number of Spectral Filters	1 per camera

2.4 Microscopic Imager (MI)

The MI is a fixed-focus science camera mounted on the end of the Rover arm (Instrument Deployment Device, or IDD). The MI is designed to acquire images at a spatial resolution of 30 μm per pixel over a broadband spectral range (400 nm to 700 nm). Technically speaking, the “microscopic” imager is not actually a microscope – the MI has a fixed magnification of 0.4.

Because the MI has a relatively small depth of field (+/- 3 mm), a single MI image of a rough surface (one that has “bumpiness” larger than +/- 3 mm) will contain both focused and unfocused areas. To focus unfocused areas of an image, (which also has the effect of defocusing the areas that were previously in focus), the IDD is moved by a small amount and an additional MI image is acquired. By combining a set of images acquired in this way, a completely focused image can be assembled.

MI optics characteristics useful in the analysis of EDR and RDR products are described in Table 2.4.1 below:

Table 2.4.1 - MI Optics Characteristics

Characteristic	Value
Field of View (FOV)	3 x 3 cm
Spatial Resolution	30 μm/pixel
Angular Resolution	0.637 mrad/pixel
Spectral Bandpass	400 - 700 nm
Number of Spectral Filters	1, plus yellow dust cover window

Whenever the MI is not in use, the MI optics are protected from contamination by a dust cover. The cover includes a yellow window that allows imaging even when the cover is closed. The dust cover window restricts the MI bandpass to 550 - 700 nm, allowing crude color information to be obtained by taking images with the cover open and closed. The spectral bandwidths are described in Table 2.4.2 below:

Table 2.4.2 - MI Spectral Filters

Filter Position	Camera Dust Cover State	Wavelength (Bandpass), nm
0	NULL or N/A	NULL or N/A
1	CLOSED	500 - 700
2	OPEN	400 - 700

2.5 Descent Camera (Descam)

The Descam is mounted on the lander radar bracket and points downward during lander descent. The Descam was added to the lander payload after much of the overall camera design effort had been completed and as a result shares the identical optical design as the Navcams, an f/12 optical system with a 45 x 45 degree field of view, a 60.7 degree diagonal FOV, and an angular resolution of 0.82 mrad/pixel at the image center. The Descam camera uses a broadband filter with a center at 750 nm and a Full Width at Half Maximum (FWHM) of approximately 200 nm.

Three Descam images will be acquired during EDL. The vehicle altitudes for these images will range from 2000 to 1200 m above the surface. To acquire the images rapidly, the images will be commanded with the minimum allowable exposure time of 5.1 ms and the 4 x 1 hardware binning option. The per-pixel resolution of these images will be approximately 4 x 1 m.

Descam optics characteristics useful in the analysis of EDR and RDR products are described in Table 2.5 below:

Table 2.5 – Descent Camera Optics Characteristics

Characteristic	Value
Field of View (FOV)	45 deg x 45 deg
Diagonal FOV	60.7 deg
Angular Resolution	0.82 mrad/pixel
Spatial Resolution	4 x 1m/pixel
Spectral Bandpass	750 nm
Number of Spectral Filters	1

3. DATA PROCESSING OVERVIEW

3.1 Data Processing Level

This documentation uses the “Committee on Data Management and Computation” (CODMAC) data level numbering system. The MER Camera Payload EDRs referred to in this document are considered “Level 2” or “Edited Data” (equivalent to NASA Level 0). The EDRs are to be reconstructed from “Level 1” or “Raw Data”, which are the telemetry packets within the project specific Standard Formatted Data Unit (SFDU) record. They are to be assembled into complete images, but will not be radiometrically or geometrically corrected.

MER Camera Payload RDRs are considered “Level 3” (“Calibrated Data” equivalent to NASA Level 1-A), “Level 4” (“Resampled Data” equivalent to NASA Level 1-B), or “Level 5” (“Derived Data” equivalent to NASA Level 1-C, 2 or 3). The RDRs are to be reconstructed from “Level 2” edited data, and are to be assembled into complete images that may include radiometric and/or geometric correction.

Refer to Table 3.1 for a breakdown of the CODMAC and NASA data processing levels.

Table 3.1 - Processing Levels for Science Data Sets

NASA	CODMAC	Description
Packet data	Raw - Level 1	Telemetry data stream as received at the ground station, with science and engineering data embedded.
Level 0	Edited - Level 2	Instrument science data (e.g., raw voltages, counts) at full resolution, time ordered, with duplicates and transmission errors removed.
Level 1-A	Calibrated - Level 3	Level 0 data that have been located in space and may have been transformed (e.g., calibrated, rearranged) in a reversible manner and packaged with needed ancillary and auxiliary data (e.g., radiances with the calibration equations applied).
Level 1-B	Resampled - Level 4	Irreversibly transformed (e.g., resampled, remapped, calibrated) values of the instrument measurements (e.g., radiances, magnetic field strength).
Level 1-C	Derived - Level 5	Level 1A or 1B data that have been resampled and mapped onto uniform space-time grids. The data are calibrated (i.e., radiometrically corrected) and may have additional corrections applied (e.g., terrain correction).
Level 2	Derived - Level 5	Geophysical parameters, generally derived from Level 1 data, and located in space and time commensurate with instrument location, pointing, and sampling.
Level 3	Derived - Level 5	Geophysical parameters mapped onto uniform space-time grids.

3.2 Data Generation

MER Camera Payload EDRs and RDRs will be generated by JPL’s Multimission Image Processing Laboratory (MIPL) under the OPGS subsystem of the MER GDS. EDRs and RDRs will also be generated by the Athena Pancam Science and Microscopic Imager Science Teams under the SOAS subsystem of the MER GDS.

3.2.1 EDR Data Product

There will be two types of nominal EDR data products generated during the mission, and their applications characterize them as the “Operations EDR” and the “Science EDR”.

3.2.1.1 Operations EDR

As the fundamental operations image data archive product, the Operations EDR will be generated as “raw” uncalibrated data within an automated pipeline process managed by MIPL under OPGS at JPL as part of the critical path in rover traversability operations. The size of an Operations EDR data product is approximately 2 MB. The total estimated volume of Operations EDRs over the course of the nominal 90-day MER mission is approximately 35 Gigabytes.

3.2.1.1.1 Data Flow

The Operations EDR processing begins with the reconstruction of packetized telemetry data resident on the TDS by the System Software (SSW) program “mer_dp” into a binary data product and matching meta-data file. The data product and meta-data are written to the OSS and symbolic links to each are created in a repository directory under the OPGS substructure on the OSS, where they are ingested by MIPL’s telemetry processor “mertelemproc” and processed with SPICE kernels provided by NAIF. The Operations EDR will be generated 60 seconds after the binary data product and matching meta-data have been symbolically linked into the OPGS repository directory. This data flow is illustrated in Figure 3.3.1.1.1, and is elaborated in the Data Format discussion:

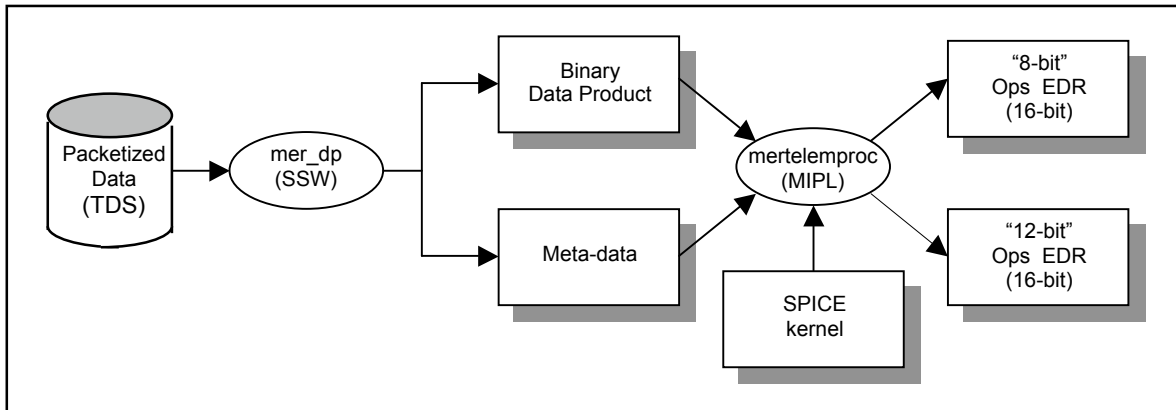

Figure 3.3.1.1.1 – Operations EDR Generation

3.2.1.1.2 Data Format

The Operations EDR will be formatted according to this SIS, such that each of the two radiometric formats of telemetry data will be stored “unscaled” in a signed 16-bit integer. In the first case, 12-bit data scaled onboard to 8-bit via a “12 to 8-bit” Lookup Table (LUT) or, by bit shifting, will be downlinked as 8-bit data and stored “as is” in the eight lowest bits of the signed 16-bit integer. In the second case,

12-bit data without onboard LUT scaling or bit shifting will be downlinked as 12-bit data and stored “as is” in the 12 lowest bits of the signed 16-bit integer.

There will not be multiple versions of the Operations EDR. Missing packets will be identified and reported for retransmission to the ground as “partial datasets”. Prior to retransmission, the missing Operations EDR data will be filled with zeros. The Operations EDR data will be reprocessed only after all “partial datasets” are retransmitted and received on the ground. In these cases, the original Operations EDR version will be overwritten, retaining only a single version. The Operations EDR data product will be placed into FEI for distribution and to facilitate the archiving process.

3.2.1.2 Science EDR

As the fundamental science image data archive product, the Science EDR will be generated by the Athena Pancam Science and Microscopic Imager Science Teams under SOAS at JPL to recover the original 12-bit raw measurement obtained by the respective science camera to within the uncertainty of the noise in the original measured value. The size of a Science EDR data product is approximately 2 MB. The total estimated volume of Science EDRs over the course of the nominal 90-day MER mission is less than that of the Operations EDRs, and depends on the definition of the Science EDR archive set (see sections on Data Flow and Data Format).

3.2.1.2.1 Data Flow

The EDR produced will be the Operations EDR processed further by utilizing Pancam and M.I. SOAS tools to generate exactly the same data format and label keywords (but not keyword values) as the Operations EDR. This data flow is illustrated in Figure 3.3.1.2.1, and is elaborated in the Data Format discussion.

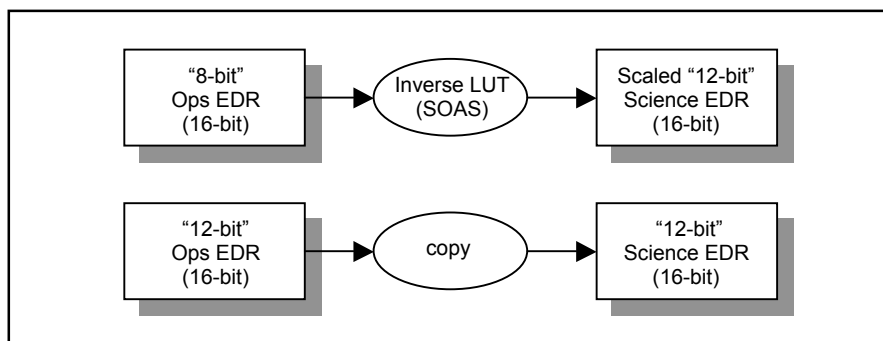

Figure 3.3.1.2.1 – Science EDR Generation

3.2.1.2.2 Data Format

As shown in Figure 3.3.1.2.1, there are two cases of the Science EDR. If the Operations EDR is effectively in 8-bit format (e.g., valid data only in the eight lowest bits of the 16-bit integer) because a user-defined “12 to 8-bit” LUT was applied onboard prior to downlink, then a corresponding Science EDR is generated by applying the appropriate Inverse LUT (ILUT) to the Operations EDR. Refer to Appendix C for a listing of the ILUTs. If the Operations EDR is in 12-bit format (e.g., valid data in the 12 lowest bits of the 16-bit integer) because no LUT was applied onboard, it is copied without change in binary data content and renamed as a Science EDR to complete the uniform set of all Science EDRs.

The SOAS software will perform some minor reformatting of the PDS label, such as adding spaces for improved readability, breaking up long text strings across multiple lines, etc. The Science EDR will

share the same filenaming convention as the Operations EDR, altering only the Product Creator character in the filename to “C” (for Athena Pancam Team, Cornell University) or “F” (for Microscopic Imager Team, USGS, Flagstaff) to differentiate it from the “M” (for MIPL) in the Operations EDR filename. See Section 4.4 for details on the filenaming conventions.

Like the Operations EDR, there will not be multiple versions of the Science EDR. The Science EDR data product will be placed into FEI to facilitate the archiving process.

3.2.2 RDR Data Product

RDR data products will be generated by, but not limited to, MIPL using the Mars Suite of VICAR image processing software at JPL, the Athena Pancam Science Team using IDL software at Cornell University and JPL, and the Microscopic Imager Science Team using ISIS software at USGS (Flagstaff) and JPL. The RDRs produced will be “processed” data. The input will be one or more Camera EDR or RDR data products and the output will be formatted according to this SIS. Additional meta-data may be added by the software to the PDS label.

There may be multiple versions of a MER Camera RDRs. The RDR data product will be placed into FEI for distribution.

3.3 Data Validation

Validation of the MER EDRs will fall into two primary categories: automated and manual. Automated validation will be performed on every EDR product produced for the mission. Manual validation will only be performed on a subset.

Automated validation will be performed as a part of the archiving process and will be done simultaneously with the archive volume validation. Validation operations performed will include such things as verification that the checksum in the label matches a calculated checksum for the data product (i.e., that the data product included in the archive is identical to that produced by the real-time process), a validation of the PDS syntax of the label, a check of the label values against the database and against the index tables included on the archive volume, and checks for internal consistency of the label items. The latter include such things as verifying that the product creation date is later than the earth received time, and comparing the geometry pointing information with the specified target. As problems are discovered and/or new possibilities identified for automated verification, they will be added to the validation procedure.

Manual validation of the images will be performed both as spot-checking of data through-out the life of the mission, and comprehensive validation of a sub-set of the data (for example, a couple of days' worth of data). These products will be viewed by a human being. Validation in this case will include inspection of the image or other data object for errors (like missing lines) not specified in the label parameters, verification that the target shown / apparent geometry matches that specified in the labels, verification that the product is viewable using the specified software tools, and a general check for any problems that might not have been anticipated in the automated validation procedure.

4. DATA PRODUCT OVERVIEW

The data in the EDR data product is a copy of the scene that had been projected onto the camera instrument’s charge-coupled device (CCD) and shifted into the CCD memory buffer. That is, the EDR consists of unprocessed experiment data stored in binary format. A total of 1024 x1024 image pixels plus 32 reference pixels per line are each digitized to 12 bits resolution. The binary data may be returned as 12-bit or 8-bit scaled data. The returned uncompressed 12-bit binary data is “packed” during transmission and stored in the EDR as a signed 16-bit integer. The returned uncompressed 8-bit binary data is also stored in the EDR as a signed 16-bit integer. Compressed data is ICER or LOCO encoded. The camera acquisition of the scene and subsequent onboard storage and readout of pre-flight EDR image data, using Ground Support Equipment (GSE), is illustrated in Figure 4 below. Note that for flight EDRs, the Reference Pixels are returned separately from the rest of the image:

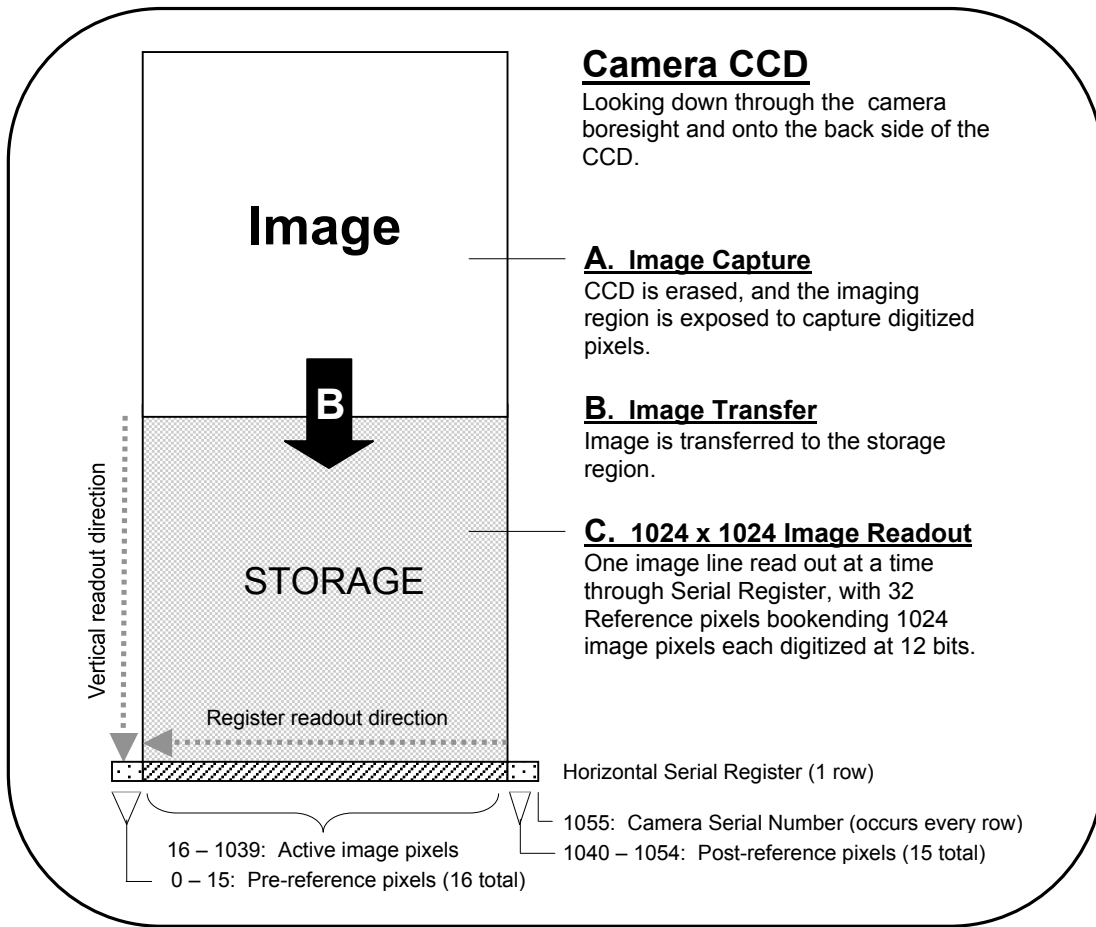

Figure 4 - Acquisition and Readout of Full Frame Pre-Flight EDR Using GSE

4.1 Data Product Structure

EDR products will have two possible structures. The Operations EDR structure consists of an ASCII PDS label, followed by an embedded ASCII VICAR label, followed by a n x m block of binary image data with the origin at the upper left pixel in line (row) 1, sample (column) 1. Inherent to the VICAR

label is the possibility of an ASCII EOL label being appended after the binary data in order to handle label modifications. This EOL label is simply a continuation field for the main VICAR label, when there is no more space for expansion before the image data. The EDR products will be processed to eliminate the optional EOL label (Figure 4.1.1, Diagram A). The Science EDR structure consists of an ASCII PDS label followed by a n x m block of binary image data (Figure 4.1.1, Diagram B). Note that some camera EDR products will be rotated so that the origin (1,1) is not the same as the CCD origin, and for more details refer to [Ref 3].

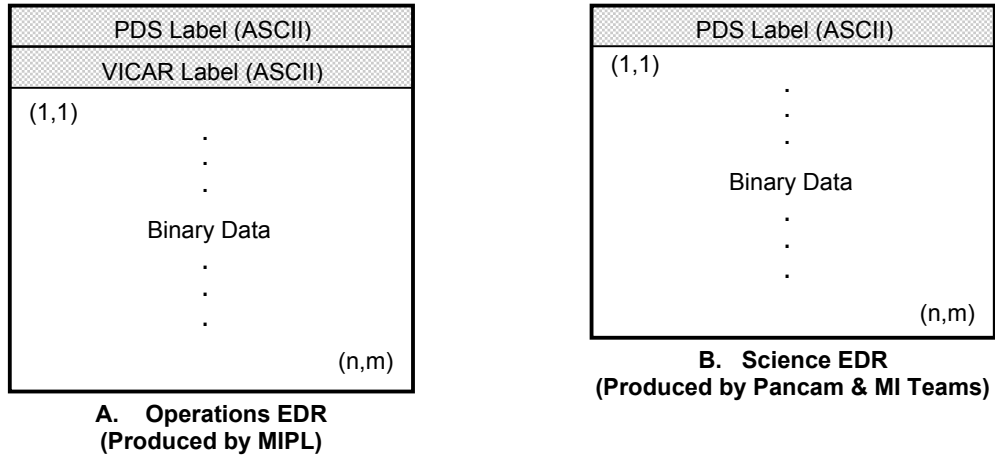

Figure 4.1.1 - EDR Structures

RDR products will have three possible structures. RDRs generated by MIPL will have a VICAR label wrapped by a PDS label, and their structure can include the optional EOL label after the binary data (Figure 4.1.2, Diagram A). RDR products not generated by MIPL may contain only a PDS label (Figure 4.1.2, Diagram B). Or, RDR products conforming to a standard other than PDS, such as JPEG compressed or certain Terrain products (Figure 4.1.2, Diagram C), are acceptable without a PDS header during mission operations, but may not be archivable. For a description of the PDS label, see Section 4.2.1, and for a description of the VICAR Label, see Section 4.2.2, and for a mapping between the two, see Section 4.2.3.

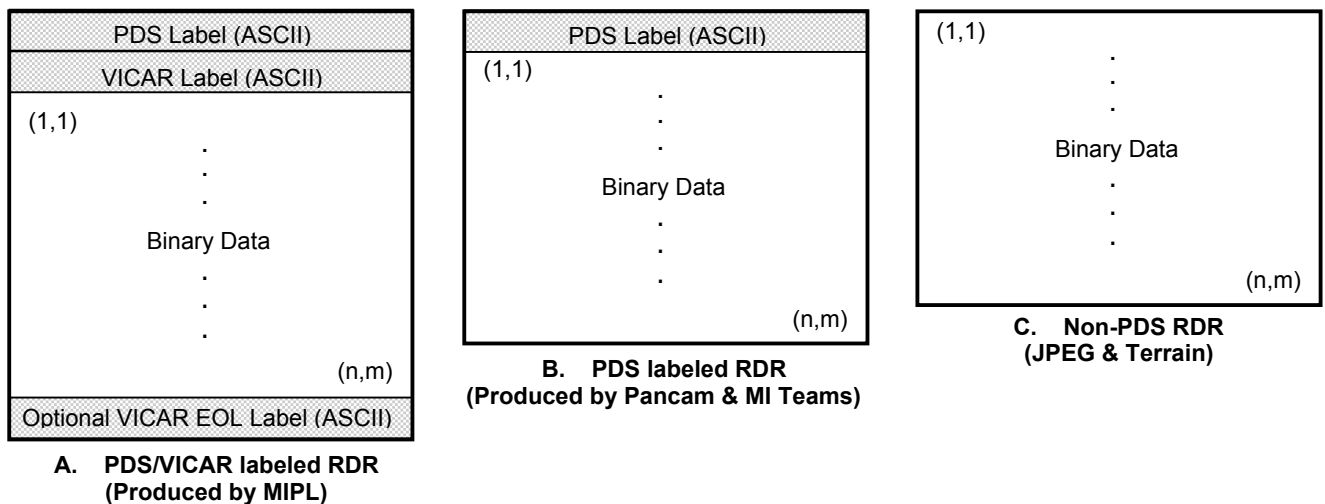

Figure 4.1.2 - RDR Structures

4.2 Label and Header Descriptions

4.2.1 PDS Label

MER Camera Payload EDRs and RDRs, with the exception of the OPGS Terrain RDR, have an attached PDS label. The OPGS Terrain RDR has a detached PDS label. Each institution is responsible for converting PDS-formatted image products to be compatible with their own software systems (such as VICAR, IDL, ISIS, etc.).

A PDS label is object-oriented and describes the objects in the data file. The PDS label contains keywords for product identification. The label also contains descriptive information needed to interpret or process the data in the file.

PDS labels are written in Object Description Language (ODL) (see Reference 4). PDS label statements have the form of "keyword = value". Each label statement is terminated with a carriage return character (ASCII 13) and a line feed character (ASCII 10) sequence to allow the label to be read by many operating systems. Pointer statements with the following format are used to indicate the location of data objects in the file:

$$^{\text{object}} = \text{location}$$

where the carat character (^, also called a pointer) is followed by the name of the specific data object. The location is the 1-based starting record number for the data object within the file.

4.2.1.1 PDS Image Object

An IMAGE object is a two-dimensional array of values, all of the same type, each of which is referred to as a *sample*. IMAGE objects are normally processed with special display tools to produce a visual representation of the samples by assigning brightness levels or display colors to the values. An IMAGE consists of a series of lines, each containing the same number of samples.

The required IMAGE keywords define the parameters for simple IMAGE objects:

- LINES is the number of lines in the image.
- LINE_SAMPLES is the number of samples in each line.
- SAMPLE_BITS is the number of bits in each individual sample.
- SAMPLE_TYPE defines the sample data type.

The IMAGE object has a number of keywords relating to image statistics. These keywords will be present in all EDRs. In RDRs, they are optional, and if they are present, they must be updated to reflect the current statistics of the image (often they will be omitted for the sake of computational efficiency). Note that the VICAR label never contains these keywords; see section 4.2.3. The statistics keywords are:

- MEAN
- MEDIAN
- MAXIMUM
- MINIMUM

- STANDARD_DEVIATION
- CHECKSUM

Many variations on the basic IMAGE object are possible with the addition of optional keywords and/or objects. The “^IMAGE” keyword identifies the start of the image data and will skip over the VICAR label. Recommended image formats are described and illustrated in Reference 4, Appendix A.19.

4.2.1.2 Keyword Length Limits

All PDS keywords are limited to 30 characters in length (Section 12.7.3 in PDS Standards Reference). Therefore, software that reads MER PDS labels must be able to ingest keywords up to 30 characters in length.

For RDR producing institutions wishing to accommodate the VICAR mapping (see Section 4.2.3) of PDS keywords that use a *<unit>* tag after the value, such keywords must be limited to 26 characters in length. Otherwise, those keywords will not be transcoded from the PDS label into a VICAR label.

4.2.1.3 Data Type Restrictions

In order to accommodate VICAR dual-labeled files, 16-bit data must be stored as signed data. Unsigned 16-bit data is not supported. 12-bit unsigned data from the cameras is stored in a 16-bit signed value.

4.2.1.4 Interpretation of N/A, UNK, and NULL

During the completion of data product labels or catalog files, one or more values may not be available for some set of required data elements. In this case PDS provides the symbolic literals “N/A”, “UNK”, and “NULL”, each of which is appropriate under different circumstances.

As a note, if any one of these three symbolic literals are used in place of a keyword value that is normally followed by a Unit Tag(s) (e.g., “*<value>*”), the Unit Tag(s) is removed from the label.

- “N/A” (“Not Applicable”) indicates that the values within the domain of this data element are not applicable in this instance. For example, a data set catalog file describing NAIF SPK kernels would contain the line:

```
INSTRUMENT_ID = "N/A"
```

because this data set is not associated with a particular instrument.

“N/A” may be used as needed for data elements of any type (e.g., text, date, numeric, etc.).

- “UNK” (“Unknown”) indicates that the value for the data element is not known and never will be. For example, in a data set comprising a series of images, each taken with a different filter, one of the labels might contain the line:

```
FILTER_NAME = "UNK"
```

if the observing log recording the filter name was lost or destroyed and the name of the filter is not otherwise recoverable.

“UNK” may be used as needed for data elements of any type.

- “NULL” is used to flag values that are *temporarily* unknown. It indicates that the data preparer recognizes that a specific value should be applied, but that the true value was not readily available. “NULL” is a placeholder. For example, the line:

DATA_SET_RELEASE_DATE = "NULL"

might be used in a data set catalog file during the development and review process to indicate that the release date has not yet been determined.

“NULL” may be used as needed for data elements of any type.

Note that all “NULL” indicators should be replaced by their actual values prior to final archiving of the associated data.

4.2.1.5 PDS Label Constructs “Class”, “Object” and “Group”

The PDS has designed a set of formal and informal constructs for labeling data products. In the PDS realm, “formal” infers a standardized design or set of rules that provides a protocol across multiple data products (e.g., multiple flight missions) for PDS validation tools, and involves a rigorous approval process. “Informal” infers a less rigorous process by which the construct meets PDS approval. For both formal and informal constructs, the member keywords must be defined in the *Planetary Science Data Dictionary* (PSDD) [Ref 30]. In MER Camera EDRs and RDRs, the PDS Label includes the following “formal” and “informal” constructs:

- **Class** - The Class construct is informal and resides in a PDS label as a grouping of keywords that are thematically tied together. Classes are usually preceded by a label comment, although it is not required. PDS label comments are character strings bounded by “/* */” characters.

In the MER Camera PDS label a Class of keywords will be preceded by a comment string as follows:

```
/* comment string */
keyword      = keyword value
keyword      = keyword value
```

- **Object** - The Object construct is formal and is a set of standard keywords used for a particular data product. In the PSDD, each Object definition lists the elements required to be present each time the Object is used in a product label. The PSDD also provides a list of additional, optional keywords that are frequently used in the Object. Any element defined in the PSDD may be included as an optional element in any Object definition, at the discretion of the data preparer.

In the MER Camera PDS label an Object’s set of keywords is specified as follows:

```
OBJECT          = Object identifier
keyword         = keyword value
keyword         = keyword value
END_OBJECT      = Object identifier
```

- **Group** - The Group construct can be either a formal or informal grouping of keywords that are not components of a larger Object. Group keywords may reside in more than one Group within the label.

The Group construct is further described in section 12.4.5 of the PDS Standards Reference, "Object Description Language Specification and Usage: GROUP Statement".

In the MER Camera PDS label, a Group's set of keywords is specified as follows:

```
GROUP           = Group identifier
  keyword       = keyword value
  keyword       = keyword value
END_GROUP      = Group identifier
```

4.2.2 VICAR Label

For all EDR data products and MIPL produced RDR data products, an embedded VICAR label follows the PDS label and is pointed to by the PDS pointer "`^IMAGE_HEADER`". The VICAR label is also organized in an ASCII, "keyword = value" format, although there are only spaces between keywords (no carriage return/line feeds as in PDS). The information in the VICAR label is an exact copy of the information in the PDS label as defined in the next section. The reader is referred to the VICAR File Format document for details of the format, which is available at the URL "http://www-mipl.jpl.nasa.gov/vicar/vic_file_fmt.html". The following text is an excerpt which describes the basic structure:

A VICAR file consists of two major parts: the labels, which describe what the file is, and the image area, which contains the actual image. The labels are potentially split into two parts, one at the beginning of the file, and one at the end. Normally, only the labels at the front of the file will be present. However, if the EOL keyword in the system label (described below) is equal to 1, then the EOL labels (End Of file Labels) are present. This happens if the labels expand beyond the space allocated for them. The VICAR file is treated as a series of fixed-length records, of size RECSIZE (see below). The image area always starts at a record boundary, so there may be unused space at the end of the label, before the actual image data starts.

The label consists of a sequence of "keyword=value" pairs that describe the image, and is made up entirely of ASCII characters. Each keyword-value pair is separated by spaces. Keywords are strings, up to 32 characters in length, and consist of uppercase characters, underscores ("`_`"), and numbers (but should start with a letter). Values may be integer, real, or strings, and may be multiple (e.g. an array of 5 integers, but types cannot be mixed in a single value). Spaces may appear on either side of the equals character (`=`), but are not normally present. The first keyword is always LBLSIZE, which specifies the size of the label area in bytes. LBLSIZE is always a multiple of RECSIZE, even if the labels don't fill up the record. If the labels end before LBLSIZE is reached (the normal case), then a 0 byte terminates the label string. If the labels are exactly LBLSIZE bytes long, a null terminator is not necessarily present. The size of the label string is determined by the occurrence of the first 0 byte, or LBLSIZE bytes, whichever is smaller. If the system keyword EOL has the value 1, then End-Of-file Labels exist at the end of the image area (see above). The EOL labels, if present, start with another LBLSIZE keyword, which is treated exactly the same as the main LBLSIZE keyword. The length of the EOL labels is the smaller of the length to the first 0 byte or the EOL's LBLSIZE. Note that the main LBLSIZE does not include the size of the EOL labels. In order to read in the full label string, simply read in the EOL labels, strip off the LBLSIZE keyword, and append the rest to the end of the main label string.

4.2.3 Mapping of PDS and VICAR Labels

The information contained in the PDS and VICAR embedded labels are identical, by definition. Either label may be used interchangeably, for any purpose in the mission. Any MIPL software that modifies one label must also modify the other. This is often most easily accomplished by stripping off one of the headers, processing the remaining label as desired locally, and then running a conversion tool to re-create the missing header. Such tools will be provided by MIPL.

It is important to note that these files are simultaneously valid PDS images, and valid VICAR images, and may be processed equally by tools of either system. It is critical for the integrity of the data that both labels be maintained, as described above.

The mapping between PDS keywords is straightforward. Appendix A shows a label in PDS format. For space reasons, the corresponding VICAR label is omitted from this document, but it is required. The mapping rules are as follows:

- Keyword values are identical in both cases. The only changes to values are those mandated by the file format itself, such as quoting rules. See the respective PDS and VICAR documents for details, but in general, PDS uses double quotes (") while VICAR uses single quotes (').
- With the exception of keywords defining the file format itself (described below), keyword names are identical in both cases.
- Any PDS group maps 1-to-1 to a VICAR property set with the same name (group name == property set name). All contained keywords are identical in both cases. The GROUP and END-GROUP keywords are omitted from the VICAR label; PROPERTY keywords are used instead (as per the VICAR file format definition).
- Any set of PDS keywords not in a group (in PDS terms, a class) is identified by an introductory comment (e.g. /* IDENTIFICATION DATA ELEMENTS */). Such classes map 1-to-1 to a VICAR property set. The name of the VICAR property set and the name of the PDS introductory comment map as follows:

Table 4.2.3 - PDS Class to VICAR Property Set Mappings

PDS Class Comment	VICAR Property Set Name
/* FILE DATA ELEMENTS */	special case, see below
/* POINTERS TO DATA OBJECTS */	special case, see below
/* IDENTIFICATION DATA ELEMENTS */	IDENTIFICATION
/* TELEMETRY DATA ELEMENTS */	TELEMETRY
/* HISTORY DATA ELEMENTS */	PDS_HISTORY
/* COMPRESSION RESULTS */	COMPRESSION_PARMS

- PDS comments (i.e., /* *string* */) are stored in a VICAR keyword named "PDS_COMMENT". This keyword appears in the VICAR property containing the elements immediately following the comment. When converting from VICAR to PDS, the comment is placed immediately before the group or class. Blank lines should surround the comment. Note that with OPGS-generated EDR and RDR data products, multiple comment lines in a Group are not supported.

- The PDS objects IMAGE_HEADER and IMAGE, as well as the keywords in /* FILE DATA ELEMENTS */ and /* POINTERS TO DATA OBJECTS */ in the table above, do not map directly to VICAR. They all describe the layout of the file and the image data. The VICAR equivalent for all of these items is the VICAR System label. Information maps between these in a straightforward way. It should be trivial to construct a VICAR system label and the above-referenced PDS entities after referring to the respective file-format-definition documents. Note that the /* FILE DATA ELEMENTS */ and /* POINTERS TO DATA OBJECTS */ comments are constant and so are not mapped to PDS_COMMENT keywords in the VICAR label. They are inserted automatically as part of the system label conversion process.
- The statistics-related keywords in the PDS IMAGE object are MEAN, MEDIAN, MAXIMUM, MINIMUM, STANDARD_DEVIATION, and CHECKSUM. These keywords are never transferred to the VICAR label. For VICAR -> PDS conversion, they can be computed from the image, or simply omitted from the PDS image (for RDRs only - EDRs require them).
- A few remaining items in the PDS_IMAGE object are treated specially. The FIRST_LINE, FIRST_LINE_SAMPLE, INVALID_CONSTANT, and MISSING_CONSTANT keywords are transferred to the VICAR IMAGE_DATA property set.
- Any PDS keyword with a <unit> tag after the value is transferred to the VICAR label without the unit tag. A VICAR keyword with the same name, but with "__UNIT" (two underscores) appended to the end, is added with the value of the unit. So for example, the PDS keyword "EXPOSURE_TIME = 1.5 <s>" would translate to two VICAR keywords: "EXPOSURE_TIME = 1.5" and "EXPOSURE_TIME__UNIT = SEC". Note that because of this, any PDS keyword that can support a unit is limited to 26 characters. If there is more than one value (an array), a unit is associated with each. In this case, the "__UNIT" VICAR keyword becomes multi-valued also, with each unit copied in sequence. If one of the elements does not have a unit (but others do), the corresponding entry is "N/A" (which is not copied to the PDS label). So for example, PDS "CONTRIVED_ANGLE = (1.2 <rad>, 22.0, 54.1 <deg>)" would map to VICAR "CONTRIVED_ANGLE = (1.2, 22.0, 54.1)" and "CONTRIVED_ANGLE__UNIT = (RAD, N/A, DEG)".
- The VICAR history label is omitted from the PDS header

4.3 Binary Data Storage Conventions

MER Camera Payload EDR data are stored as binary data. The data are 12-bit integers stored in signed 16-bit integers, or rescaled 8-bit integers stored in signed 16-bit integers with only the lowest ordered 8 bits being valid. The PDS and VICAR labels are stored as ASCII text.

4.3.1 Bit and Byte Ordering

The ordering of bits and bytes is only significant for pixel data; all other labeling information is in ASCII.

For non-byte data, which includes 16-bit signed shorts, 32-bit signed ints, and 32- and 64-bit IEEE floating-point numbers, the data may be stored in either Most Significant Byte first ("big-endian", as used by e.g. Sun computers and Java), or Least Significant Byte first ("little-endian", as used by e.g. Linux and Windows computers). This follows both the PDS and VICAR file format conventions.

For PDS, the SAMPLE_TYPE label in the IMAGE object defines which ordering is used in the file. For VICAR, the INTFMT and REALFMT labels in the System label define the ordering. See the respective PDS and VICAR file format definition documents.

Both file formats specify that bit 0 is the least significant bit of a byte. MER EDR's may be constrained to use MSB only, but RDR's still need to be flexible.

Table 4.3.1 - MER Camera EDR and RDR Bit Ordering

Address	MSB-first	LSB-first
n	most significant byte	least significant byte
n+1	next	next
n+2	next	next
n+3	least significant byte	most significant byte

4.4 File Naming

There are three file naming schemes adapted for the MER image and non-image data products. The first applies to the EDR data product and all Single-frame RDR data products. The second applies to all Mosaic RDR data products. Both file naming schemes adhere to the Level II 27.3 filename convention to be compliant with PDS standards. The third applies to Terrain products, and does not adhere to the PDS Level II 27.3 filename standard.

4.4.1 EDR and Single-frame RDR

Each MER EDR and Single-frame RDR data product can be uniquely identified by incorporating into the product filename the Rover Mission identifier, the Instrument identifier, the Starting Spacecraft Clock count (SCLK) of the camera event, the data Product Type, the Site location, the rover Position within the site, the Sequence number, the camera “Eye”, the spectral Filter, the product Creator identifier and a Version number.

As mentioned in Section 3.3.1, the EDR filename will distinguish the Operations EDR from the Science EDR via the product Creator field. The Operations EDR will employ character “M” (for MIPL), while the Science EDR will employ either character “C” (for Athena Pancam Team, Cornell University) or “F” (for Microscopic Imager Team, USGS, Flagstaff).

The Single-frame RDR data products that share the naming scheme with the EDR data product are numerous. They are listed in the description of the Product Type field found in the filename convention definition, which follows:

<scid><inst><sclk><prod><site><pos><seq><eye><filt><who><ver><ext>

where,

scid = (1 integer) MER rover Spacecraft Identifier.

Valid values:

Mission Name	Rover Name	Nominal (Flight) I.D.	Simulated (Ground) I.D.
MER-A	MER-2	"2"	"4"
MER-B	MER-1	"1"	"3"

inst = (1 alpha character) MER science instrument identifier.

Valid values for MER camera instruments:

- | | |
|--------------------|--------------------------|
| "P" - Pancam | "R" - Rear Hazcam |
| "N" - Navcam | "M" - Microscopic Imager |
| "F" - Front Hazcam | "E" - Descam |

Valid values for MER instruments not described in this SIS:

- | | |
|-----------------|---------------------------|
| "A" - APXS | "T" - Mini-TES |
| "B" - Mössbauer | "D" - RAT ("D" for Drill) |

sclk = (9 integers) Starting Spacecraft Clock time.

prod = (3 alpha characters) Product Type identifier of input data. Product types are differentiated as having camera-induced distortion removed ("linearized") or not removed (nominal), and, as being Thumbnail-sized or not. Four special flag characters follow:

- Beginning "E" – Type of EDR, which are raw with no camera model "linearization" or radiometric correction. If no beginning "E", then it is an RDR.
- Ending "T" – EDR or RDR that is Thumbnail -sized.
- Ending "L" – If no beginning "E", denotes an RDR that is "Linearized", except for Thumbnail sized RDRs.
- Ending "N" – If no beginning "E", denotes an RDR that is ThumbNail-sized and "LiNearized".

Valid values for MER camera instrument input data products:

Data Product	Non-linearized (NOMINAL)	Linearized
Full frame EDR	"EFF"	n/a
Sub-frame EDR	"ESF"	n/a
Downsampled EDR	"EDN"	n/a
Thumbnail EDR	"ETH"	n/a
Row Summed EDR	"ERS"	n/a
Column Summed EDR	"ECS"	n/a
Reference Pixels EDR	"ERP"	n/a
Histogram EDR	"EHG"	n/a
Inverse LUT RDR	"ILF"	"FFL"
Inverse LUT RDR (Sub-frame)	"ISF"	"SFL"
Inverse LUT RDR (Downsampled)	"INN"	"DNL"
Inverse LUT RDR (Thumbnail)	"ITH"	"THN"
Radiometrically-corrected RDR calibrated to absolute radiance units	"RAD"	"RAL"
Radiometrically-corrected RDR calibrated to absolute radiance units (Thumbnail)	"RAT"	"RAN"
MIPLRAD Radiometrically-corrected RDR calibrated to absolute radiance units, specific to archived datasets only	"MRD"	"MRL"

MIPLRAD Radiometrically-corrected RDR calibrated to absolute radiance units, specific to archived datasets only (Thumbnail)	"MRT"	"MRN"
Rad-corrected Float (32-bit) RDR	"RFD"	"RFL"
Rad-corrected Float (32-bit) RDR (Thumbnail)	"RFT"	"RFN"
Radiometrically-corrected RDR calibrated to I/F radiance factor	"IOF"	"IOL"
Radiometrically-corrected RDR calibrated to I/F radiance factor (Thumbnail)	"IOT"	"ION"
Rad-corrected Float (32-bit) RDR calibrated to I/F radiance factor	"IFF"	"IFL"
Rad-corrected Float (32-bit) RDR calibrated to I/F radiance factor (Thumbnail)	"IFT"	"IFN"
Radiometrically-corrected RDR calibrated for instrument effects only, in DN	"CCD"	"CCL"
Radiometrically-corrected RDR calibrated for instrument effects only, in DN (Thumbnail)	"CCT"	"CCN"
Rad-corrected Float (32-bit) RDR calibrated for instrument effects only, in DN	"CFD"	"CFL"
Rad-corrected Float (32-bit) RDR calibrated for instrument effects only, in DN (Thumbnail)	"CFT"	"CFN"
Disparity RDR	"DIS"	"DIL"
Disparity RDR (Thumbnail)	"DIT"	"DIN"
Disparity of Samples RDR	"DSS"	"DSL"
Disparity of Samples RDR (Thumbnail)	"DST"	"DSN"
Disparity of Lines RDR	"DLS"	"DLL"
Disparity of Lines RDR (Thumbnail)	"DLT"	"DLN"
XYZ RDR	"XYZ"	"XYL"
XYZ RDR (Thumbnail)	"XYT"	"XYN"
XYZ Rover Vol Exclusion Mask RDR	"MSK"	"MSL"
XYZ Rover Vol Exclusion Mask RDR (Thumbnail)	"MST"	"MSN"
X Component RDR	"XXX"	"XXL"
X Component RDR (Thumbnail)	"XXT"	"XXN"
Y Component RDR	"YYY"	"YYL"
Y Component RDR (Thumbnail)	"YYT"	"YYN"
Z Component RDR	"ZZZ"	"ZZL"
Z Component RDR (Thumbnail)	"ZZT"	"ZZN"
Range (Distance) RDR	"RNG"	"RNL"
Range (Distance) RDR (Thumbnail)	"RNT"	"RNN"
UVW (XYZ) Surface Normal RDR	"UVW"	"UVL"
UVW (XYZ) Surface Normal RDR (Thumbnail)	"UVT"	"UVN"
U (X) Surface Normal RDR	"UUU"	"UUL"
U (X) Surface Normal RDR (Thumbnail)	"UUT"	"UUN"
V (Y) Surface Normal RDR	"VVV"	"VVL"
V (Y) Surface Normal RDR (Thumbnail)	"VVT"	"VVN"
W (Z) Surface Normal RDR	"WWW"	"WWL"
W (Z) Surface Normal RDR (Thumbnail)	"WWT"	"WWN"
Surface Roughness RDR	"RUF"	"RUL"
Surface Roughness RDR (Thumbnail)	"RUT"	"RUN"
Slope RDR	"SLP"	"SLL"
Slope RDR (Thumbnail)	"SLT"	"SLN"
Slope Rover Direction RDR	"SRD"	"SRL"

Slope Rover Direction RDR (Thumbnail)	"SRT"	"SRN"
Slope Heading RDR	"SHP"	"SHL"
Slope Heading RDR (Thumbnail)	"SHT"	"SHN"
Slope Magnitude RDR	"SMP"	"SML"
Slope Magnitude RDR (Thumbnail)	"SMT"	"SMN"
Solar Energy Product RDR	"SEP"	"SEL"
Solar Energy Product RDR (Thumbnail)	"SET"	"SEN"
IDD Reachability RDR	"IDD"	"IDL"
IDD Reachability RDR (Thumbnail)	"IDT"	"IDN"
VISTA Terrain RDR	"VIS"	"VIL"
VISTA Terrain RDR (Thumbnail)	"VIT"	"VIN"
ASD Terrain RDR	"ASD"	"ASL"
ASD Terrain RDR (Thumbnail)	"AST"	"ASN"

Valid values for MER non-camera instrument products not described in this SIS:

- "EDR" - Nominal instrument data product
- "EMS" - Mini-TES Spectra Emissivity Image Cube
- "MIN" - Mini-TES Mineral Abundance Image or Map
- "QUB" - Mini-TES Data Cube (general)
- "SPE" - APXS / MB spectra
- "TBL" - APXS / MB table on concentrations and components
- "TTH" - Mini-TES Temperature and Thermal Inertia Map

site = (2 alphanumeric) Site location count. Use of both integers and alphas allows for a total range of 0 thru 1295. A value greater than 1295 is denoted by "##" (2 pound signs), requiring the user to extract actual value from label.

The valid values, in their progression, are as follows:

- Range 0 thru 99 - "00", "01", "02"... "99"
- Range 100 thru 1035 - "A0", "A1" ... "A9", "AA", "AB"... "AZ", "B0", "B1"... "ZZ"
- Range 1036 thru 1295 - "0A", "0B"... "0Z", "1A", "1B"... "9Z"
- Range 1296 or greater - "##" (2 pound signs)

Example value is "AK" for value of 120.

pos = (2 alphanumeric) Position-within-Site count. Use of both integers and alphas allows for a total range of 0 thru 1295. A value greater than 1295 is denoted by "##" (2 pound signs), requiring the user to extract actual value from label.

The valid values, in their progression, are as follows:

- Range 0 thru 99 - "00", "01", "02"... "99"
- Range 100 thru 1035 - "A0", "A1" ... "A9", "AA", "AB"... "AZ", "B0", "B1"... "ZZ"
- Range 1036 thru 1295 - "0A", "0B"... "0Z", "1A", "1B"... "9Z"
- Range 1296 or greater - "##" (2 pound signs)

Example value is "AK" for value of 120.

seq = (1 alpha character plus 4 integers) Sequence identifier. Denotes a group of related commands used as keys for the Ops processing.

Valid values for character (position 1) in field:

"C" - Cruise	"P" - PMA & Remote Sensing instr. (Pancam, Navcam, Hazcam, MI, Mini-TES)
"D" - IDD & RAT	"R" - Rover Driving
"E" - Engineering	"S" - Submaster
"F" - Flight Software (Seq rejected)	"T" - Test
"G" - (spare)	"W" - Seq triggered by a Commun. Window
"K" - (spare)	"X" - Contingency
"M" - Master (Surface only)	"Y" - (spare)
"N" - In-Situ instr. (APXS, MB, MI)	"Z" - SCM Seq's

Valid values for integers (positions 2 thru 5) in field:

"0000" thru "4095" - Valid Sequence number, commanded by Ground

If "F" in character position:

- 1000's - Commanded by NAV
- 2000's - Commanded by SAPP
- 3000's - Commanded by Fault Protection
- 4000's - Commanded by EDL

If "P" in character position:

- 0000 through 0499 - Misc. imaging setup/parm sequences
- 0500 through 0999 - Navcam sequences (allocated during Extended Mission)
- 1000 through 1499 - Hazcam sequences
- 1500 through 1999 - Navcam sequences
- 2000 through 2899 - Pancam sequences
- 2900 through 2999 - MI sequences
- 3000 through 3999 - Mini-TES sequences
- 4000 through 4095 - Misc. PMA actuation sequences (deploy, etc.)

Example value is "P0268".

eye = (1 alpha character) Camera eye. Valid values are:

- | | |
|--------------------------------------|--|
| "L" - Left camera eye | "A" - 3-banded Anaglyph of Left, Right, Right eyes mapped to Red, Green, Blue channels |
| "R" - Right camera eye | |
| "M" - Monoscopic (non-stereo camera) | "N" - Not Applicable |

filt = (1 alphanumeric) Spectral filter position. Valid values are an integer range of 0-8 (0 = "no filter" or "N/A", 1 thru 8 are valid filter positions), or "C" (for 3-band Color). For the Pancam filter positions, refer to Table 2.1.2. For the Microscopic Imager filter positions, refer to Table 2.4.2. This field supports 3 types of scenerios:

- a) Single-banded image - If value is an integer, specifies the single filter position.
- b) 3-banded Anaglyph - If value is an integer and if value of "eye" field is "A", specifies filter position from Left eye as part of the Left-Right-Right (LRR) eye position mapping to Red-Green-Blue (RGB) channel positions, respectively. Consult file's PDS label to identify filter position for the Right eye (see keywords "FILTER_NUMBER" and "FILTER_NAME"). Multi-banded images can be band-sequential, pixel-interleaved or pixel-sequential.
- c) 3-banded Color image - If value is "C", specifies that image is Color and is comprised of 3 spectral bands. Consult file's PDS label to identify the 3 filter positions (see keywords "FILTER_NUMBER" and "FILTER_NAME") that map to the Red, Green and Blue channel positions. Multi-banded images can be band-sequential, pixel-interleaved or pixel-sequential.

who = (1 alpha character) Product Creator indicator. Valid values are:

- | | |
|--|-------------------------------------|
| “A” - Arizona State University | “P” - Max Plank Institute (Germany) |
| “C” - Cornell University | “S” - SOAS at JPL |
| “F” - USGS at Flagstaff | “U” - University of Arizona |
| “J” - Johannes Gutenberg Univ. (Germany) | “V” - SSV Team (E. De Jong) at JPL |
| “M” - MIPL (OPGS) at JPL | “X” - Other |
| “N” - NASA Ames Research (L. Edwards) | |

NOTE: If product is an EDR, then “M” denotes it as an Operations EDR and either “C” or “F” denote it as a Science EDR.

ver = (1 alphanumeric) Version identifier providing uniqueness for book keeping.

The valid values, in their progression, are as follows:

- Range 1 thru 9 - “1”, “2”... “9”
- Range 10 thru 35 - “A”, “B” ... “Z”

Example value is “E” for value of 14.

ext = (4 alpha characters) 3-character PDS product type extension following a "." character.

Valid values for nominal operations camera data products:

- “.IMG” - Camera image EDRs and RDRs (PDS labeled).
- “.VST” - Camera VST Terrain RDR (no PDS label).

Valid values for quick-look JPEG compressed camera data products:

- “.JPG” - JPEG compressed (no PDS label).
- “_n.JPG” - Scaled and JPEG compressed, where “n” is “2” for 1/2 scale, “4” for 1/4 scale, or “8” for 1/8 scale (no PDS label). The filenames for these products are not PDS compliant, being longer than the “27.3” PDS nomenclature.

Valid values for In-situ instrument data products not described in this SIS:

- “.QUB” - Mini-TES Data Cube
- “.DAT” - APXS spectra, Mössbauer spectra, RAT binary data
- “.LBL” - Detached PDS labels for APXS and Mössbauer data
- “.TAB” - APXS table data, Mössbauer table data

Examples:

- | | | |
|----|---------------------------------|--|
| a) | 2P123456789IOF0103P2210L2C1.IMG | Mission MER-A (“2”), Pancam instrument (“P”), SCLK 123456789 (“123456789”), Radiometrically-corrected RDR calibrated to I/F radiance factor (“IOF”), Site 1 (“01”), Position 3 (“03”), Seq p2210 (“P2210”), left Eye (“L”), Filter position 2 (“2”), produced by Cornell U. (“C”), product version 1 (“1”), PDS-labeled (“IMG”). |
| b) | 2M123456789EFF0103P2901M0F2.IMG | Mission MER-A (“2”), Microscopic Imager instrument (“M”), SCLK 123456789 (“123456789”), Full Frame EDR (“EFF”), Site 1 (“01”), Position 3 (“03”), Sequence p2901 (“P2901”), Monoscopic (“M”), no Filter (“0”), produced by USGS/Flagstaff (“F”), product version 2 (“2”), PDS-labeled (“IMG”). |
| c) | 1P123456789RAD0103P2210RCM1.IMG | Mission MER-B (“1”), Pancam instrument (“P”), SCLK 123456789 (“123456789”), Radiometrically-corrected RDR calibrated to absolute units (“RAD”), Site 1 (“01”), Position 3 (“03”), Seq p2210 (“P2210”), right Eye (“R”), 3 filter positions identified in PDS label to produce 3-banded Color (“C”), produced by OPGS/MIPL (“M”), product version 1 (“1”), PDS-labeled (“IMG”). |

- d) 1N123456789FFL0103P1501A0M1.IMG Mission MER-B ("1"), Navcam instrument ("N"), SCLK 123456789 ("123456789"), "linearized" Full Frame RDR ("FFL"), Site 1 ("01"), Position 3 ("03"), Sequence p1501 ("P1501"), 3-banded Anaglyph in Left-Right-Right to RGB mapping ("A"), Filter position 0 from Left eye ("0"), produced by OPGS/MIPL ("M"), product version 1 ("1"), PDS-labeled ("IMG").
- e) 2F123456789XYL6627F4000R0M1.JPG Mission MER-A ("2"), Front Hazcam instrument ("F"), SCLK 123456789 ("123456789"), "linearized" XYZ RDR ("XYL"), Site 66 ("66"), Position 27 ("27"), Sequence f4000 commanded by EDL ("F4000"), right Eye ("R"), no Filter ("0"), produced by OPGS/MIPL ("M"), product version 1 ("1"), JPEG compressed with no PDS label ("JPG").
- f) 1N123456789VIL0103P1501L5M1.VST Mission MER-B ("1"), Navcam instrument ("N"), SCLK 123456789 ("123456789"), "linearized" terrain wedge RDR ("VIL"), Site 1 ("01"), Position 3 ("03"), Sequence p1501 ("P1501"), left Eye ("L"), Filter position 5 ("5"), produced by OPGS/MIPL ("M"), product version 1 ("1"), VISTA format ("VST").

4.4.2 Mosaic RDR

The MER camera Mosaic RDR data products are usually derived from multiple EDR or RDR data products mosaicked together, although they can also be derived from single data products. They are uniquely identified by incorporating into the product filename the Rover mission identifier, the "primary" Instrument identifier, the "secondary" Instrument identifier, the Starting Sol denoting the start of mosaic data, the geometric Projection type, the Product Type ingested to build the mosaic, the Starting Site location, the rover's Starting Position within the site, the camera "Eye", the spectral Filter, the product Creator identifier and a Version number.

The filename convention follows:

<scid><inst1><inst2><sol><prod><site><proj><pos><seq><eye><filt><who><ver><ext>

where,

scid = (1 integer) MER rover Spacecraft Identifier.

Valid values:

Mission Name	Rover Name	Nominal (Flight) I.D.	Simulated (Ground) I.D.
MER-A	MER-2	"2"	"4"
MER-B	MER-1	"1"	"3"

inst1 = (1 alpha character) "Primary" MER science instrument identifier. Specifies the dominant instrument data type in the Mosaic RDR product. Valid values are:

- “P” - Pancam
- “R” - Rear Hazcam
- “N” - Navcam
- “M” - Microscopic Imager
- “F” - Front Hazcam
- “E” - Descam

inst2 = (1 alpha character) "Secondary" MER science instrument identifier. Specifies the second most dominant instrument data type in the Mosaic RDR product. If all data in the Mosaic RDR is from a single instrument, then value is same as "inst1" value. Valid values are:

- “P” - Pancam
- “R” - Rear Hazcam
- “N” - Navcam
- “M” - Microscopic Imager
- “F” - Front Hazcam
- “E” - Descam

sol = (3 integers) Starting Sol. Indicates the Sol of the first (in time order, the lowest SCLK) mosaic chip, denoting the start of mosaic data acquisition. Example value is “004”.

prod = (3 alpha characters) Product Type identifier of input data. Product types are differentiated as having camera-induced distortion removed (“linearized”) or not removed (nominal), and, as being Thumbnail-sized or not. Four special flag characters follow:

- a) Beginning “E” – Type of EDR, which are raw with no camera model “linearization” or radiometric correction. If no beginning “E”, then it is an RDR.
- b) Ending “T” – EDR or RDR that is Thumbnail -sized.
- c) Ending “L” – If no beginning “E”, denotes an RDR that is “Linearized”, except for Thumbnail sized RDRs.
- d) Ending “N” – If no beginning “E”, denotes an RDR that is ThumbNail-sized and “LiNearized”.

Valid values for MER camera instrument input data products:

Data Product	Non-linearized (NOMINAL)	Linearized
Full frame EDR	“EFF”	n/a
Sub-frame EDR	“ESF”	n/a
Downsampled EDR	“EDN”	n/a
Thumbnail EDR	“ETH”	n/a
Inverse LUT RDR	“ILF”	“FFL”
Inverse LUT RDR (Sub-frame)	“ISF”	“SFL”
Inverse LUT RDR (Downsampled)	“INN”	“DNL”
Inverse LUT RDR (Thumbnail)	“ITH”	“THN”
Radiometrically-corrected RDR calibrated to absolute radiance units	“RAD”	“RAL”
Radiometrically-corrected RDR calibrated to absolute radiance units (Thumbnail)	“RAT”	“RAN”
MIPLRAD Radiometrically-corrected RDR calibrated to absolute radiance units, specific to archived datasets only	“MRD”	“MRL”
MIPLRAD Radiometrically-corrected RDR calibrated to absolute radiance units, specific to archived datasets only (Thumbnail)	“MRT”	“MRN”
Rad-corrected Float (32-bit) RDR	“RFD”	“RFL”
Rad-corrected Float (32-bit) RDR (Thumbnail)	“RFT”	“RFN”
Radiometrically-corrected RDR calibrated to I/F radiance factor	“IOF”	“IOL”
Radiometrically-corrected RDR calibrated to I/F radiance factor (Thumbnail)	“IOT”	“ION”
Rad-corrected Float (32-bit) RDR calibrated to I/F radiance factor	“IFF”	“IFL”

Rad-corrected Float (32-bit) RDR calibrated to I/F radiance factor (Thumbnail)	"IFT"	"IFN"
Radiometrically-corrected RDR calibrated for instrument effects only, in DN	"CCD"	"CCL"
Radiometrically-corrected RDR calibrated for instrument effects only, in DN (Thumbnail)	"CCT"	"CCN"
Rad-corrected Float (32-bit) RDR calibrated for instrument effects only, in DN	"CFD"	"CFL"
Rad-corrected Float (32-bit) RDR calibrated for instrument effects only, in DN (Thumbnail)	"CFT"	"CFN"
Disparity RDR	"DIS"	"DIL"
Disparity RDR (Thumbnail)	"DIT"	"DIN"
Disparity of Samples RDR	"DSS"	"DSL"
Disparity of Samples RDR (Thumbnail)	"DST"	"DSN"
Disparity of Lines RDR	"DLS"	"DLL"
Disparity of Lines RDR (Thumbnail)	"DLT"	"DLN"
XYZ RDR	"XYZ"	"XYL"
XYZ RDR (Thumbnail)	"XYT"	"XYN"
X Component RDR	"XXX"	"XXL"
X Component RDR (Thumbnail)	"XXT"	"XXN"
Y Component RDR	"YYY"	"YYL"
Y Component RDR (Thumbnail)	"YYT"	"YYN"
Z Component RDR	"ZZZ"	"ZZL"
Z Component RDR (Thumbnail)	"ZZT"	"ZZN"
Range (Distance) RDR	"RNG"	"RNL"
Range (Distance) RDR (Thumbnail)	"RNT"	"RNN"
UVW (XYZ) Surface Normal RDR	"UVW"	"UVL"
UVW (XYZ) Surface Normal RDR (Thumbnail)	"UVT"	"UVN"
U (X) Surface Normal RDR	"UUU"	"UUL"
U (X) Surface Normal RDR (Thumbnail)	"UUT"	"UUN"
V (Y) Surface Normal RDR	"VVV"	"VVL"
V (Y) Surface Normal RDR (Thumbnail)	"VVT"	"VVN"
W (Z) Surface Normal RDR	"WWW"	"WWL"
W (Z) Surface Normal RDR (Thumbnail)	"WWT"	"WWN"
Surface Roughness RDR	"RUF"	"RUL"
Surface Roughness RDR (Thumbnail)	"RUT"	"RUN"
Slope RDR	"SLP"	"SLL"
Slope RDR (Thumbnail)	"SLT"	"SLN"
Slope Rover Direction RDR	"SRD"	"SRL"
Slope Rover Direction RDR (Thumbnail)	"SRT"	"SRN"
Solar Energy Product RDR	"SEP"	"SEL"
Solar Energy Product RDR (Thumbnail)	"SET"	"SEN"
IDD Reachability RDR	"IDD"	"IDL"
IDD Reachability RDR (Thumbnail)	"IDT"	"IDN"

site = (2 alphanumeric) Site location count. Use of both integers and alphas allows for a total range of 0 thru 1295. A value greater than 1295 is denoted by "##" (2 pound signs), requiring the user to extract actual value from label.

The valid values, in their progression, are as follows:

Range 0 thru 99 - "00", "01", "02"... "99"

Range 100 thru 1035 - "A0", "A1" ... "A9", "AA", "AB"... "AZ", "B0", "B1"... "ZZ"

Range 1036 thru 1295 - "0A", "0B"... "0Z", "1A", "1B"... "9Z"

Range 1296 or greater - "##" (2 pound signs)

Example value is "AK" for value of 120.

proj = (3 alpha characters) Projection type. Indicates the projection or perspective of the product. Valid values are:

"CYL" - Cylindrical projection	"POL" - Polar projection
"PER" - Camera Point Perspective	"VRT" - Vertical projection
"CYP" - Cylindrical-Perspective projection	"ORT" - Orthographic projection

pos = (2 alphanumeric) Position-within-Site count. Use of both integers and alphas allows for a total range of 0 thru 1295. A value greater than 1295 is denoted by "##" (2 pound signs), requiring the user to extract actual value from label.

The valid values, in their progression, are as follows:

Range 0 thru 99	- "00", "01", "02"... "99"
Range 100 thru 1035	- "A0", "A1" ... "A9", "AA", "AB"... "AZ", "B0", "B1"... "ZZ"
Range 1036 thru 1295	- "0A", "0B"... "0Z", "1A", "1B"... "9Z"
Range 1296 or greater	- "##" (2 pound signs)

Example value is "AK" for value of 120.

seq = (1 alpha character plus 4 integers) "Primary" Sequence identifier, which is extracted from first EDR built into the Mosaic RDR based on SCLK sorting. Denotes a group of related commands used as keys for the Ops processing.

Valid values for character (position 1) in field:

"C" - Cruise	"P" - PMA & Remote Sensing instr. (Pancam, Navcam, Hazcam, MI, Mini-TES)
"D" - IDD & RAT	"R" - Rover Driving
"E" - Engineering	"S" - Submaster
"F" - Flight Software (Seq rejected)	"T" - Test
"G" - (spare)	"W" - Seq triggered by a Commun. Window
"K" - (spare)	"X" - Contingency
"M" - Master (Surface only)	"Y" - (spare)
"N" - In-Situ instr. (APXS, MB, MI)	"Z" - SCM Seq's

Valid values for integers (positions 2 thru 5) in field:

"0000" thru "4095" - Valid Sequence number, commanded by Ground

If "F" in character position:

1000's	- Commanded by NAV
2000's	- Commanded by SAPP
3000's	- Commanded by Fault Protection
4000's	- Commanded by EDL

If "P" in character position:

0000 through 0499	- Misc. imaging setup/parm sequences
0500 through 0999	- Navcam sequences (allocated during Extended Mission)
1000 through 1499	- Hazcam sequences
1500 through 1999	- Navcam sequences
2000 through 2899	- Pancam sequences
2900 through 2999	- MI sequences
3000 through 3999	- Mini-TES sequences
4000 through 4095	- Misc. PMA actuation sequences (deploy, etc.)

Example value is "P0268".

eye = (1 alpha character) Camera eye. Valid values are:

- “L” - Left camera eye
- “R” - Right camera eye
- “M” - Monoscopic (non-stereo camera)
- “A” - 3-banded Anaglyph of Left, Right, Right eyes mapped to Red, Green, Blue channels
- “N” - Not Applicable

filt = (3 integers) Spectral filter positions. Filter positions have a range of **0-8** (0 = “no filter” or “N/A”, 1 thru 8 are valid filter positions). For the Pancam filter positions, refer to Table 2.1.2. For the Microscopic Imager filter positions, refer to Table 2.4.2. In the case of mosaicked data acquired from multiple (mixed) instruments, values are considered the “primary filters” per user decision. This field supports 3 types of scenarios:

- a) Single-banded image - Must specify all 3 filter positions as the same value (example: “111” denotes single-banded Filter 1).
- b) 3-banded color image - The three filter numbers are specified in position order of Red, Green, Blue (RGB) channels. Multi-banded images can be band-sequential, pixel-interleaved or pixel-sequential.
- c) 3-banded Anaglyph - If value of “eye” field is “A”, then the RGB channel positions also are mapped to eye positions Left, Right, Right (LRR). Multi-banded images can be band-sequential, pixel-interleaved or pixel-sequential.

who = (1 alpha character) Product Creator indicator. Valid values are:

- “A” - Arizona State University
- “C” - Cornell University
- “F” - USGS at Flagstaff
- “J” - Johannes Gutenberg Univ. (Germany)
- “M” - MIPL (OPGS) at JPL
- “N” - NASA Ames Research (L. Edwards)
- “P” - Max Plank Institute (Germany)
- “S” - SOAS at JPL
- “U” - University of Arizona
- “V” - SSV Team (E. De Jong) at JPL
- “X” - Other

ver = (1 alphanumeric) Version identifier providing uniqueness for book keeping.

The valid values, in their progression, are as follows:

- Range 1 thru 9 - “1”, “2”... “9”
- Range 10 thru 35 - “A”, “B” ... “Z”

Example value is “E” for value of 14.

ext = (4 alpha characters) 3-character PDS product type extension following a "." character.

Valid values for nominal operations camera data products:

- “.IMG” - Camera image EDRs and RDRs (PDS labeled).
- “.JPG” - JPEG compressed (no PDS label).

Examples:

- a) 2PN004RAD02CYL09P2210R592C1.IMG Mission MER-A ("2"), Pancam as primary instrument ("P"), mixed with secondary instrument Navcam data ("N"), starting Sol 4 ("004"), mosaic built from Radiometrically-corrected RDRs ("RAD"), starting Site 2 ("02"), Cylindrical projection ("CYL"), starting Position 9 ("09"), Sequence p2210 ("P2210"), right Eye ("R"), Filters 3, 2, and 1 ("321"), produced by Cornell U. ("C"), product version 1 ("1"), PDS-labeled ("IMG"). This is a 3-banded color image.

- b) 2MM004EDN02PER09P2901L000F1.IMG Mission MER-A ("2"), Microscopic Imager as primary ("M") and secondary instrument ("M") to denote no mixing of instrument data, starting Sol 4 ("004"), mosaic built from Downsampled EDRs ("EDN"), starting Site 2 ("02"), Camera Point Perspective ("PER"), starting Position 9 ("09"), Sequence p2901 ("P2901"), left Eye ("L"), no Filter ("000" = "N/A"), produced by USGS/Flagstaff ("F"), product version 1 ("1"), PDS-labeled ("IMG"). This is a 1-banded BW image.
- c) 1NN004EFF02VRT09P1501L000M1.IMG Mission MER-B ("1"), Navcam as primary ("N") and secondary instrument ("N") to denote no mixing of instrument data, starting Sol 4 ("004"), mosaic built from Full Frame EDRs ("EFF"), starting Site 2 ("02"), Vertical projection ("VRT"), starting Position 9 ("09"), Sequence p1501 ("P1501"), left Eye ("L"), no Filter ("000" = "N/A"), produced by OPGS/MIPL ("M"), product version 01 ("1"), PDS-labeled ("IMG"). This is a 1-banded BW image.
- d) 1PP004EFF02CYP09P0062A711M1.IMG Mission MER-B ("1"), Pancam as primary ("P") and secondary instrument ("P") to denote no mixing of instrument data, starting Sol 4 ("004"), mosaic built from Full Frame EDRs ("EFF"), starting Site 2 ("02"), Cylindrical-Perspective projection ("CYP"), starting Position 9 ("09"), Sequence p0062 ("P0062"), Anaglyph ("A"), mapping of Left Filter 7, Right Filter 1, Right Filter 1 to Red, Green, Blue respectively ("711"), produced by OPGS/MIPL ("M"), product version 01 ("1"), PDS-labeled ("IMG"). This is a 3-banded "monochromatic" Anaglyph image for stereo viewing.

4.4.3 Terrain Mesh RDR

Each MER Terrain Mesh RDR product can be uniquely identified by incorporating into the product filename the Rover Mission identifier, the Ending Sol identifier, the Instrument type(s) identifier, the Last Site location, the input Product Type identifier(s), the rover's last Position within the last Site, and a Version number. The filename does not comply to the PDS 27.3 standard, nor is it fixed length.

The filename convention follows:

<scid>mesh_<sol>[X]_<inst>_<site>[X]_<prod>[-<prod>]_<pos>[X]_V<ver><ext>

where "[]" denotes optional characters,

and where,

scid = (1 integer) MER rover Spacecraft Identifier.

Valid values:

Mission Name	Rover Name	Nominal (Flight) I.D.	Simulated (Ground) I.D.
MER-A	MER-2	"2"	"4"
MER-B	MER-1	"1"	"3"

- sol** = (1 to 3 integers) Ending Sol. Indicates the Sol of the last (in time order, the highest SCLK) input image built into the Terrain Mesh RDR. If followed by an "x" character, indicates Sol is the last of multiple Sols represented in the Terrain Mesh RDR.
- inst** = (N alpha characters) MER science instrument(s) identifier. Specifies the instrument data type(s) that were built into the Terrain Mesh RDR product. Valid values are:
 - "P" - Pancam
 - "N" - Navcam
 - "F" - Front Hazcam
 - "R" - Rear Hazcam
 - "O" - Orbiter
- site** = (1 to 3 integers) Ending Site location count. Indicates the Site of the last (in time order, the highest SCLK) input image built into the Terrain Mesh RDR. If followed by an "x" character, indicates Site is the last of multiple Sites represented in the Terrain Mesh RDR.
- prod** = (N alpha characters) 3-character Product Type identifier(s) of input image(s) that were built into the Terrain Mesh RDR product. Multiple values are delimited by a hyphen ("-") character.

Valid 3-character values are:

- "FFL" - Full Frame (full resolution), linearized.
- "SFL" - Subframe (full resolution), linearized.
- "DNL" - Downsampled (subsampling resolution), linearized.
- "THN" - Thumbnail (64x64 subsampling resolution), linearized.

- pos** = (1 to 3 integers) Ending Position location count. Indicates the Position of the last (in time order, the highest SCLK) input image built into the Terrain Mesh RDR. If followed by an "x" character, indicates Position is the last of multiple Positions from within the last Site represented in the Terrain Mesh RDR.
- ver** = (N integers) Version identifier providing uniqueness for book keeping.
- ext** = (3 or 4 alpha characters) Product type extension following a "." character.

Valid values are:

- ".pfb" - Terrain Mesh product in Performer Binary format
- ".iv" - Terrain Mesh product in Inventor format (for MIPL use)
- ".ht" - Height Map with VICAR label

Examples:

- a) 2mesh_26_N_12_FFL_5_v1.pfb
 Mission MER-A ("2"), last image acquired on Sol 26 ("26"), Navcam instrument data ("N"), last image acquired at Site 12 ("12"), built from Full Frame "linearized" RDRs ("FFL"), last image acquired at Position 5 ("5"), product version 1 ("1"), Performer Binary formatted Terrain Mesh product ("pfb").

- b) 1mesh_26x_NFR_12x_FFL-DNL_5x_v1.pfb Mission MER-B ("1"), last image acquired on Sol 26 as the last of several Sols ("26x"), Navcam, Front & Rear Hazcam instrument data ("NFR"), last image acquired at Site 12 as last of several Sites ("12x"), built from Full Frame "linearized" and Downsampled "linearized" RDRs ("FFL-DNL"), last image acquired at Position 5 as last of several Positions in last Site ("5x"), product version 1 ("1"), Performer Binary formatted Terrain Mesh product ("pfb").

- c) 2mesh_32_PN_21_FFL_17_v1.ht Mission MER-A ("2"), last image acquired on Sol 32 ("32"), Pancam and Navcam instrument data ("PN"), last image acquired at Site 21 ("21"), built from Full Frame "linearized" RDRs ("FFL"), last image acquired at Position 17 ("17"), product version 1 ("1"), VICAR-labeled Height Map product ("ht").

5. DETAILED DATA PRODUCT SPECIFICATIONS

5.1 EDR Data Products

The data packaged in the camera data files will be decoded, decompressed camera image data in single frame form as an Experiment Data Record (EDR). The Full Frame form of a standard image data file has the maximum dimensions of 1024 lines by 1024 samples. The other camera data files and their data sizes are listed in Table 5.1.

Table 5.1 - MER Camera EDR Data Products

Image Type	Image Size	Pixel Size (bits)	Description
Full Frame	1024 lines x 1024 samples	16-bit signed integer	Nominal full sized, full resolution data product. Note that if an Operations EDR and "12 to 8-bit" scaling is commanded, then the valid pixels are stored as the last 8 bits of a 16-bit integer. If a Science EDR and "12 to 8-bit" scaling is commanded, then the last 8 bits have been scaled to the last 12 bits of a 16-bit integer using an Inverse Lookup Table (ILUT).
Thumbnail	variable	16-bit signed integer	This data product is a spatially sized down version of an existing Full Frame, so is less than full size and less than full resolution. The bit scaling rules described for the Full Frame case above also apply here.
Sub-frame	variable	16-bit signed integer	Same format as Full Frame, but only a selected row (line) and/or column sub-frame is read back. ICER is also capable of subframing. The bit scaling rules described for the Full Frame case above also apply here.

Image Type	Image Size	Pixel Size (bits)	Description
Downsampled	variable (usually 1/4 size of Full Frame)	16-bit signed integer	Images are converted to smaller images via a) nearest neighbor pixel averaging, b) pixel averaging with outlier rejection, or c) computing the median pixel value. The bit scaling rules described for the Full Frame case above also apply here.
Row Summing	N lines X 1 sample	32 (unsigned)	Array of 32-bit integers whose length is equal to image height, wherein the DN value for the Jth element equals the sum of all pixels in the Jth row.
Column Summing	1 line X N samples	32 (unsigned)	Array of 32-bit integers whose length is equal to image width, wherein the DN value for the Jth element equals the sum of all pixels in the Jth column.
Reference pixels	1024 lines x 32 samples	16 (unsigned)	Dark pixels bookending (pre- and post-) image pixels during serial register readout. There are 16 “pre-” Reference and 15 “post-” Reference pixels, plus 1 for the camera hardware serial number (left-shifted by 4 bits if 12-bit data).
Histogram	1 line x 4096 samples or 1 line x 256 samples	32 (unsigned)	DN histogram computed from image can have either 256 or 4096 bins, each capable of holding count values of up to 4,194,304.

5.1.1 Full Frame EDR

Full Frame EDRs are stored as 16-bit signed integers. If 12-to-8 bit scaling is performed, then pixels are stored in 16-bit format and only the last 8 bits of the 16-bit integer are used.

5.1.2 Thumbnail EDR

Thumbnail EDRs are stored as 16-bit signed integers. If 12-to-8 bit scaling is performed, then pixels are stored in 16-bit format and only the last 8 bits of the 16-bit integer are used. The Thumbnail EDR is a sized down version of the original acquired image (i.e., camera returned pixel data), and size of the binary EDR image data is variable. However, the original acquired image is not always downlinked. The main purpose of a Thumbnail EDR is to provide an image summary using a very low data volume compared to the original image.

5.1.3 Sub-frame EDR

Sub-frame EDRs are a subset of rows and columns of the 1024x1024 full frame image. Sub-frame EDRs are stored as 16-bit signed integers. If 12-to-8 bit scaling is performed, then pixels are stored in 16-bit format and only the last 8 bits of the 16-bit integer are used.

5.1.4 Downsampled EDR

A downsampled EDR is a smaller version of the 1024x1024 full frame or subframed image using the following methods: 1) nearest neighbor pixel averaging, 2) pixel averaging with outlier rejection or 3) computing the median pixel value. Downsampled EDRs are stored as 16-bit signed integers. If 12-to-8 bit scaling is performed, then pixels are stored in 16-bit format and only the last 8 bits of the 16-bit integer are used.

5.1.5 Row Summation EDR

A row summation EDR is the summing of the rows of an full-frame or subframed image and returning the results. The EDR is a $n \times 1$ array of 32-bit integers (whose length is equal to the image height) where the DN value of the i th element is the value of the sum of all the pixels in the i th row.

5.1.6 Column Summation EDR

A column summation EDR is the summing of the columns of an full-frame or sub-framed image and returning the results. The EDR is a $1 \times n$ array of 32-bit integers (whose length is equal to the image width) where the DN value of the i th element is the value of the sum of all the pixels in the i th column.

5.1.7 Reference Pixels

The onboard CCD array has 16 "pre-Reference" dark pixels (12-bits) located at the beginning and 15 "post-Reference" dark pixels (12-bits) located at the end of each row. Following the last "post-Reference" dark pixel, at the very end of each row, is the camera hardware serial number (left-shifted by 4 bits if 12-bit data).

5.1.8 Histogram EDR

The histogram EDR is a 32-bit integer array storing the histogram of the image. A 1×256 or 1×4096 array will be returned.

5.2 RDR Data Products

The RDR data product is comprised of radiometrically decalibrated and/or camera model corrected and/or geometrically altered versions of the raw camera data, in both single and multi-frame (mosaic) form. Most RDR data products will have PDS labels, or if generated by MIPL (OPGS), dual PDS/VICAR labels. Non-labeled RDRs include JPEG compressed products and the Terrain products. The RDR data products that serve operational needs are listed in Table 5.2 below.

Table 5.2 - MER Camera RDR Data Products

Data Product	# Bands	Data Type	Data Structure	PDS Sample Type
Inverse LUT RDR	1	16-bit signed integer	Dual PDS/VICAR (OPGS) binary file.	MSB_UNSIGNED_INTEGER or MSB_INTEGER
Radiometrically Corrected RDR	1	16-bit signed integer	PDS (SOAS) or dual PDS/VICAR (OPGS) binary file.	MSB_INTEGER
CAHV Linearized RDR	1	16-bit signed integer	Dual PDS/VICAR (OPGS) binary file.	MSB_UNSIGNED_INTEGER or MSB_INTEGER
XYZ RDR	3	Float	Dual PDS/VICAR (OPGS) binary file.	IEEE_REAL or PC_REAL
X-component RDR	1	Float	PDS (SOAS) or dual PDS/VICAR (OPGS) binary file.	IEEE_REAL or PC_REAL
Y-component RDR	1	Float	PDS (SOAS) or dual PDS/VICAR (OPGS) binary file.	IEEE_REAL or PC_REAL
Z-component RDR	1	Float	PDS (SOAS) or dual PDS/VICAR (OPGS) binary file.	IEEE_REAL or PC_REAL
Range RDR	1	Float	Dual PDS/VICAR (OPGS) binary file.	IEEE_REAL or PC_REAL
IDD Reachability RDR	16	16-bit signed integer	Dual PDS/VICAR (OPGS) binary file.	MSB_INTEGER
Disparity RDR	2	Float	Dual PDS/VICAR (OPGS) binary file.	IEEE_REAL or PC_REAL
Line Disparity RDR	1	Float	Dual PDS/VICAR (OPGS) binary file.	IEEE_REAL or PC_REAL
Sample Disparity RDR	1	Float	Dual PDS/VICAR (OPGS) binary file.	IEEE_REAL or PC_REAL
Surface Normal (UVW) RDR	3	Float	Dual PDS/VICAR (OPGS) binary file.	IEEE_REAL or PC_REAL
Surface Normal U-component RDR	1	Float	PDS (SOAS) or dual PDS/VICAR (OPGS) binary file.	IEEE_REAL or PC_REAL
Surface Normal V-component RDR	1	Float	PDS (SOAS) or dual PDS/VICAR (OPGS) binary file.	IEEE_REAL or PC_REAL
Surface Normal W-component RDR	1	Float	PDS (SOAS) or dual PDS/VICAR (OPGS) binary file.	IEEE_REAL or PC_REAL
Surface Roughness RDR	1	Float	Dual PDS/VICAR (OPGS) binary file.	IEEE_REAL or PC_REAL
Slope RDR	1	Float	Dual PDS/VICAR (OPGS) binary file.	IEEE_REAL or PC_REAL

Data Product	# Bands	Data Type	Data Structure	PDS Sample Type
Mosaic RDR	1 or 3	16-bit signed integer or Float	PDS (SOAS) or dual PDS/VICAR (OPGS) binary file.	MSB_INTEGER, IEEE_REAL or PC_REAL
Terrain Wedge RDR	3	VISTA	VISTA, no label	N/A
Terrain Mesh RDR	3	Performer Binary (PFB)	PFB, no label	N/A
JPEG compressed RDR	1 or 3	8-bit unsigned	JPEG, no label	IEEE_REAL or PC_REAL

5.2.1 Inverse LUT RDR

This RDR is produced by OPGS to provide bit scaling that is optimized for the tools of, and completed within the time requirements imposed by, the rover planners. It is identical in fashion to the Science EDR that is produced by SOAS. If the Operations EDR is in "8-bit" format (see Section 3.2.1.1) as a result of onboard "12 to 8-bit" scaling using a Lookup Table (LUT), then an Inverse LUT (ILUT) is to be used to rescale the 8 lowest bits to the 12 lowest bits in the 16-bit signed integer. Refer to Appendix C for a listing of the ILUTs.

5.2.2 Radiometrically Corrected RDR

There are multiple methods of performing radiometric correction, distinguished by the `RADIOMETRIC_CORRECTION_TYPE` keyword. The three most common are `PANCAL`, `MICAL` and `MIPLRAD`.

5.2.2.1 PANCAL Method

This refers to radiometric correction of Panoramic Camera data only, performed by the Athena Pancam team (Cornell U.) using their suite of SOAS software tools. It is the most precise correction method applicable to Pancam data. There are three general types of Pancam RDR products that are generated by the Athena Pancam team.

For non-linearized RDR files, the three general types are:

- Instrumentally-calibrated RDRs ("CCD" files): These RDRs are generated from EDRs. They have all of the major instrumental/environmental calibrations applied, such as bias removal, dark current removal, electronic shutter smear effect removal, flat field correction, and bad pixel repair. No radiance scaling has been applied, and so the units on these files are "corrected" DN.
- Radiance-calibrated RDRs ("RAD" files): These RDRs are generated from EDRs or "CCD" RDRs. They have all the major instrumental/environmental calibrations applied as described above, and then have been scaled to absolute radiance units using either pre-flight radiometric calibration coefficients or calibration coefficients derived from in-flight observations of the Pancam calibration target. The units on these files are (W/m²/nm/sr).
- Radiance factor-calibrated RDRs ("IOF" files): These RDRs are generated from EDRs or "RAD" RDRs. They have all the major instrumental/environmental calibrations applied and have been scaled to absolute radiance units as described above, and then have been divided by the absolute radiance of the Sun at the top of the Martian atmosphere within the appropriate

Pancam bandpass, to generate radiance factor, or "I over F" values, where I is the radiance from the Martian scene and $\pi * F$ is the radiance from the Sun at the top of the Martian atmosphere. Since the solar radiance in the same units as the Mars scene radiance was divided out, these files are unitless but have values in the range of 0.0 to 1.0 (for example, average bright Mars soils exhibit I/F ~ 0.35 at 750 nm and I/F ~ 0.05 at 410 nm).

Analogous RDR file types exist for linearized (geometrically-corrected) Pancam RDRs as well, and they are labeled with the "RAL", "CCL", and "IOL" product type identifier to correspond with the "RAD", "CCD", and "IOF" types, respectively. In addition, floating point versions of these RDRs may also be generated (see Section 4.4.1).

Additional details on the radiometric processing and calibration of Pancam images can be found in the Pancam Calibration Report [Ref 14] and The Mars Exploration Rover Athena Panoramic Camera (Pancam) Investigation [Ref 15].

5.2.2.2 MICAL Method

This refers to radiometric correction of Microscopic Imager data only, performed by the Athena MI team (USGS, Flagstaff) using their suite of SOAS software tools. It is the most precise correction method applicable to MI data. There are three general types of MI RDR products that are generated by the Athena MI team.

For non-linearized RDR files, the three general types are:

- Instrumentally-calibrated RDRs ("CFD" files): These RDRs have all of the major instrumental/environmental calibrations applied, such as bias removal, dark current removal, electronic shutter smear effect removal, flat field correction, and bad pixel repair. No radiance scaling has been applied, and so the units on these files are "corrected" DN.
- Radiance-calibrated RDRs ("RAD" files): These RDRs are generated from "CFD" RDRs. They have all the major instrumental/environmental calibrations applied as described above, and then have been scaled to absolute radiance units using either pre-flight radiometric calibration coefficients or calibration coefficients derived from in-flight observations. The units of these files are (W/m²/nm/sr).
- Radiance factor-calibrated RDRs ("IFF" files): These RDRs have all the major instrumental/environmental calibrations applied and have been scaled to absolute radiance units, then divided by the absolute radiance of the Sun at the top of the Martian atmosphere within the MI bandpass, to generate radiance factor, or "I over F" values, where I is the radiance from the Martian scene and $\pi * F$ is the radiance from the Sun at the top of the Martian atmosphere. Because the solar radiance in the same units as the Mars scene radiance has been divided out, these data are dimensionless and have values in the range of 0.0 to 1.0.

Additional details on the radiometric processing and calibration of MI images can be found in the MI Calibration Report (JPL D-19830 and [Ref 29]).

5.2.2.3 MIPLRAD Method

This refers to radiometric correction of any camera instrument data systematically performed by MIPL (OPGS at JPL) to meet tactical time constraints imposed by rover planners. The resulting radiance-corrected RDRs are integrated into terrain mesh products used for traverse planning. For Pancam and

MI camera instrument data, this method is less precise than the PANCAL and MICAL methods previously discussed.

In the operations environment for the Prime and Extended Missions, MIPL's radiometrically-corrected RDR filename carries the product type designator of "RAD" for the non-linearized case and "RAL" for the linearized case. However, in the PDS archive volume, the **MIPL radiometrically-corrected RDR** carries the product type identifier "MRD" for the non-linearized case and "MRL" for the linearized case. There is no difference in image content between the "operational" and "archived" versions of MIPL's radiometrically-corrected RDR. The changes in filenames are necessary to limit the association of the "RAD" and "RAL" product type identifiers in the PDS archive volumes to only the radiance-correction processes performed by the Athena Pancam and Microscopic Imager teams.

As a special note, two bugs pertaining to MIPL's radiometric correction process were discovered during the preparation of data for PDS archival, which was after the MER Prime Mission and well into the Extended Mission. The problems involved on-board flat-field removal and temperature determination. For the purposes of this discussion, the term MIPLRAD refers to the original implementation used during Prime Mission and approximately through the first two months of Extended Mission, while MIPLRAD2 represents the corrected implementation used thereafter. Both MIPLRAD and MIPLRAD2 are valid values for RADIOMETRIC_CORRECTION_TYPE. The differences are described below. Note that all "RAD/RAL/RSD/RSL" ("MRD/MRL/RSD/RSL" in the archive volumes) types of RDRs produced by MIPL have been reprocessed with MIPLRAD2, limiting the number of MIPLRAD-processed products in the PDS archive volume to a subset of mosaics which were generated before MIPLRAD2 was implemented. Note also that no mosaics were generated from on-board flat-field images using MIPLRAD, so the only difference in the archive data is the temperature issue.

MIPLRAD is a first-order correction only and should be considered approximate. MIPLRAD first backs out any onboard flat field that was performed. It then applies the following corrections: flat field, exposure time, temperature-compensated responsivity. The result is calibrated to physical units for MER of $W/m^2/nm/sr$. The actual algorithm and equations used for MIPLRAD are shown below. Each correction is applied in sequence, to every pixel:

1. If on-board flat-fielding [Ref 27] has been applied, it is backed out according to the parameters in FLAT_FIELD_CORRECTION_PARM, which is described in Appendix B and defines $ff(x,y)$. MIPLRAD incorrectly multiplied by $ff(x,y)$ rather than divided, causing the on-board flat field to be doubled rather than removed. MIPLRAD2 correctly divides by $ff(x,y)$ as follows:

$$\text{output}(x,y) = \text{input}(x,y) / ff(x,y)$$

2. For the flat-field adjustment, the x and y coordinates are adjusted based on downsampling and subframing to find the corresponding pixel in the flat field, then the DN is divided by the flat field value:

$$\text{output}(x,y) = \text{input}(x,y) / \text{flat_field}(x',y')$$

See Appendix D for list of Flat Field filenames.

3. Exposure time is then removed. Exposure time comes from EXPOSURE_DURATION, converted to seconds:

$$\text{output}(x,y) = \text{input}(x,y) / \text{exposure_time}$$

4. The temperature responsivity is removed next. The temperature comes from the first element of INSTRUMENT_TEMPERATURE and the parameters R0, R1, and R2 come from the flat field parameter file (see Appendix D), and are different per instrument. The actual temperature formula is as follows:

$$\text{output}(x,y) = \text{input}(x,y) * (R0 + R1*\text{temp} + R2*\text{temp}*\text{temp})$$

For MIPLRAD, the temperature is simply the first element of INSTRUMENT_TEMPERATURE.

For MIPLRAD2, the temperature is dependent on the instrument. The temperature used for each instrument is determined using the following general rules (from the MER thermal team):

- a) Use the CCD temp of said camera, if it exists.
- b) Use the CCD temp of neighboring camera (left/right partner), if available.
- c) Use the CCD temp of "similar" camera (i.e., Navcam/Pancam).
- d) Use CCD temperature from any camera.
- e) Use the electronics temperature of said camera.
- f) Use the electronics temperature of similar camera.

Rules "e" and "f" are a last resort in view of the fact that MER operates warmup heaters inside the electronics (during nighttime and early morning) that raise camera electronics temperatures above CCD temperatures. Thus any CCD temperature is at higher priority than any electronics temperature measurement. The most significant consequence of this is that the MI CCD is the best available proxy for all four Hazcam CCDs. A value of 0.0 is ignored as a no-reading value, and a value greater than or equal to 50.0 (degrees C) is interpreted as a broken sensor. Either value causes that temperature to be ignored and the next one on the list tested. If none of the values is valid, a default of 0.0 degrees C is used. The temperature priority list for each instrument is specified in Table 5.2.2.2 below:

Table 5.2.2.2 – Temperature Responsivity Priority by Instrument

Order	Pan Left	Pan Right	Nav Left	Nav Right	Front Haz Left	Front Haz Right	Rear Haz Left	Rear Haz Right	MI	Des Cam
1	LEFT PAN CCD	RIGHT PAN CCD	LEFT NAV CCD	LEFT NAV CCD	MI CCD	MI CCD	MI CCD	MI CCD	MI CCD	DES CAM CCD
2	RIGHT PAN CCD	LEFT PAN CCD	LEFT PAN CCD	RIGHT PAN CCD	LEFT PAN CCD	RIGHT PAN CCD	LEFT PAN CCD	RIGHT PAN CCD	LEFT PAN CCD	
3	LEFT NAV CCD	LEFT NAV CCD	RIGHT PAN CCD	LEFT PAN CCD	LEFT NAV CCD	LEFT PAN CCD	LEFT NAV CCD	LEFT PAN CCD	RIGHT PAN CCD	
4	MI CCD	MI CCD	MI CCD	MI CCD	RIGHT PAN CCD	LEFT NAV CCD	RIGHT PAN CCD	LEFT NAV CCD	LEFT NAV CCD	
5	LEFT PAN ELECTR	LEFT PAN ELECTR	LEFT PAN ELECTR	LEFT PAN ELECTR	FRONT HAZ ELECTR	FRONT HAZ ELECTR	REAR HAZ ELECTR	REAR HAZ ELECTR	MI ELECTR	
6	FRONT HAZ ELECTR	FRONT HAZ ELECTR	FRONT HAZ ELECTR	FRONT HAZ ELECTR	REAR HAZ ELECTR	REAR HAZ ELECTR	FRONT HAZ ELECTR	FRONT HAZ ELECTR	FRONT HAZ ELECTR	

5. Finally, the result is converted to integers using the RADIANCE_OFFSET and RADIANCE_SCALING_FACTOR keywords:

$$\text{output}(x,y) = (\text{input}(x,y) - \text{RADIANCE_OFFSET}) / \text{RADIANCE_SCALING_FACTOR} + 0.5$$

5.2.3 CAHV Linearized RDR

EDRs and single-frame RDRs are described by a camera model. This model, represented by a set of vectors and numbers, permit a point in space to be traced into the image plane, and vice-versa.

EDR camera models are derived by acquiring images of a calibration target with known geometry at a fixed azimuth/elevation. The vectors representing the model are derived from analysis of this imagery. These vectors are then translated and rotated based on the actual pointing of the camera to represent the conditions of each specific image. The results are the "camera model" for the EDR.

The Navcam and Pancam use a CAHVOR model, while the Hazcams use a more general CAHVORE model. Neither are linear and involve some complex calculations to transform line/sample points in the image plane to XYZ positions in the scene. To simplify this, the images are "warped", or reprojected, such that they can be described by a linear CAHV model. This linearization process has several benefits:

- 1) It removes geometric distortions inherent in the camera instruments, with the result that straight lines in the scene are straight in the image.
- 2) It aligns the images for stereo viewing. Matching points are on the same image line in both left and right images, and both left and right models point in the same direction.
- 3) It facilitates correlation, allowing the use of 1-D correlators.
- 4) It simplifies the math involved in using the camera model.

However, it also introduces some artifacts in terms of scale change and/or omitted data (see the references).

The linearized CAHV camera model is derived from the EDR's camera model by considering both the left and right eye models and constructing a pair of matched linear CAHV models that conform to the above criteria. For details on this algorithm see the references.

The image is then projected, or warped, from the CAHVOR/CAHVORE model to the CAHV model. This involves projecting each pixel through the EDR camera model into space, intersecting it with a surface (which matters only for Hazcams and is a sphere centered on the camera), and projecting the pixel back through the CAHV model into the output image.

C - The 3D position of the entrance pupil

A - A unit vector normal to the image plane pointing outward (towards C)

H - A vector pointing roughly rightward in the image; it is a composite of the orientation of the CCD rows, the horizontal scale, the horizontal center

V - A vector pointing roughly downward in the image; it is a composite of the orientation of the CCD columns, the vertical scale, the vertical center, and A.

If P is a point in the scene then the corresponding image locations x and y can be computed from:

$$x = \frac{(P - C)H}{(P - C)A}$$

$$y = \frac{(P - C)V}{(P - C)A}$$

For details on the camera model math and calibration and more description of the CAHV-model family, see references [Ref 16] through [Ref 25].

5.2.4 XYZ RDR

An XYZ file contains 3 bands of 32-bit floating point numbers in the Band Sequential order. Alternatively, X, Y and Z may be stored in separate single-band files as a X Component RDR, Y Component RDR and Z Component RDR, respectively. The single component RDRs are implicitly the same as the XYZ file, which is described below. XYZ locations in all coordinate frames for MER are expressed in meters unless otherwise noted.

The pixels in an XYZ image are coordinates in 3-D space of the corresponding pixel in the reference image. This reference image is traditionally the left image of a stereo pair, but could be the right image for special products. The geometry of the XYZ image is the same as the geometry of the reference image. This means that for any pixel in the reference image the 3-D position of the viewed point can be obtained from the same pixel location in the XYZ image. The 3-D points can be referenced to any of the MER coordinate systems (specified by DERIVED_IMAGE_PARAMS Group in the PDS label).

Most XYZ images will contain "holes", or pixels for which no XYZ value exists. These are caused by many factors such as differences in overlap and correlation failures. Holes are indicated by X, Y, and Z all having the same specific value. This value is defined by the MISSING_CONSTANT keyword in the IMAGE object. For the XYZ RDR, this value is (0.0,0.0,0.0), meaning that all three bands must be zero (if only one or two bands are zero, that does not indicate missing data).

5.2.4.1 XYZ Rover Volume Exclusion Mask

For the purposes of Terrain Mesh RDR generation, OPGS will create "Rover Volume Exclusion Mask" files that can be applied to the XYZ RDR. The Mask files are internal OPGS files not intended for archive or use by others, but they are stored in the OSS in the same directories as the XYZ RDRs. They are used to filter out rover features from generated terrain products. They are single-band, byte files corresponding to (and derived from) an XYZ image, where 255 indicates the corresponding pixel is on the rover and should be removed, or 0 indicates the pixel should remain in the output. The contents of the label are explicitly not defined, but in practice it is usually a copy of the XYZ image's label. These Mask files will assume the 3-character Product Type values "MSK" (Full Frame, Sub-frame, Downsampled), "MST" (Thumbnail), "MSL" (linearized "MSK") and "MSN" (linearized "MST").

5.2.5 Range RDR

A Range (distance) file contains 1 band of 32-bit floating point numbers.

The pixels in a Range image represent Cartesian distances from a reference point (defined by the RANGE_ORIGIN_VECTOR keyword in the PDS label) to the XYZ position of each pixel (see XYZ RDR). This reference point is normally the camera position as defined by the C point of the camera model. A Range image is derived from an XYZ image and shares the same pixel geometry and XYZ

coordinate system. As with XYZ images, range images can contain holes, defined by MISSING_CONSTANT. For MER, this value is 0.0.

5.2.6 Disparity RDR

A Disparity file contains 2 bands of 32-bit floating point numbers in the Band Sequential order (line, sample). Alternatively, line and sample may be stored in separate single-band files.

The parallax, or difference measured in pixels, between an object location in two individual images (typically the left and right images of a stereo pair) is also called the “disparity”. Disparity files contain these disparity values in both the line and sample dimension for each pixel in the reference image. This reference image is traditionally the left image of a stereo pair, but could be the right image for special products. The geometry of the Disparity image is the same as the geometry of the reference image. This means that for any pixel in the reference image the disparity of the viewed point can be obtained from the same pixel location in the Disparity image.

The values in a Disparity image are the 1-based coordinates of the corresponding point in the non-reference image. Thus, the coordinates in the reference image are the same as the *coordinates* in the Disparity image, and the matching coordinates in the stereo partner image are the *values* in the Disparity image. Disparity values of 0.0 indicate no valid disparity exists, for example due to lack of overlap or correlation failure. This value is reflected in the MISSING_CONSTANT keyword.

5.2.7 Surface Normal (UVW) RDR

A Surface Normal (UVW) file contains 3 bands of 32-bit floating point numbers in the Band Sequential order. Alternatively, U, V and W may be stored in separate single-band files as a U Component RDR, V Component RDR and W Component RDR, respectively. The single component RDRs are implicitly the same as the UVW file, which is described below.

The pixels in a UVW image correspond to the pixels in an XYZ file, with the same image geometry. However, the pixels are interpreted as a unit vector representing the normal to the surface at the point represented by the pixel. U contains the X component of the vector, V the Y component, and W the Z component. The vector is defined to point out of the surface (e.g. upwards for a flat ground). The unit vector can be referenced to any of the MER coordinate systems (specified by the DERIVED_IMAGE_PARAMS Group in the PDS label).

Most UVW images will contain "holes", or pixels for which no UVW value exists. These are caused by many factors such as differences in overlap, correlation failures, and insufficient neighbors to compute a surface normal. Holes are indicated by U, V, and W all having the same specific value. Unlike XYZ, (0,0,0) is an invalid value for a UVW file, since they're defined to be unit vectors. Thus there's no issue with the MISSING_CONSTANT as there is with XYZ, where (0.0,0.0,0.0) is valid.

5.2.8 Surface Roughness RDR

The roughness map contains surface roughness estimates at each pixel in an XYZ image. The roughness is computed as the maximum peak-to-peak deviation from the local plane. Units are meters; that is, a pixel value of 0.05 means that the local surface about that pixel has a maximum peak-to-peak deviation along the surface normal by 0.05m (5cm). Roughness values above some useful threshold

(maximum roughness) are clipped to that threshold. If a roughness could not be computed for a pixel (e.g. because of lack of range data, or too much noise in the range data), then the roughness value at that pixel will be set to the "bad roughness" value (which must be greater than maximum roughness).

5.2.9 Slope RDR

The Slope Map RDR represents the predicted slope of the terrain as determined by Pancam and Navcam stereo imaging. The Slope Map is derived from the XYZ product by fitting a plane over a rover-sized patch in physical space for every image plane pixel in the Pancam and Navcam stereo images. The surface normal is then computed as the normal to the plane fit. Note that the surface normal used for Slope is not the same as the UVW product. While it uses fundamentally the same algorithm, the UVW product is based on a RAT-sized patch and is intended for use with IDD operations, while the surface normal used in slope calculations (which is not archived) is based on a rover-sized patch. Finally, the elevation of the surface normal vector with respect to the (X,Y) site frame is determined to be the predicted terrain slope in units of degrees.

5.2.10 IDD Reachability RDR

An IDD Reachability map contains information about whether or not the instruments on the IDD can "reach" (contact or image) the object or location represented by each pixel in the scene. It is derived from the XYZ and Surface Normal (UVW) products.

The geometry of the reachability map matches the linearized reference, XYZ, and Surface Normal (UVW) images, in that each pixel in the file directly corresponds to the pixel at the same location in the other products.

The reachability map is a 16-band byte image in standard Band Sequential order. Thus for each pixel there are 16 values. These values represent reachability for each of the 4 IDD instruments in each of its 4 configurations. The mapping between band number and instrument/configuration is given by the INSTRUMENT_BAND_ID and CONFIGURATION_BAND_ID labels, and is summarized in Table 5.2.6.

Table 5.2.6 - IDD Reachability Band Assignments

IDD Configuration	Instrument			
	MI	RAT	MB	APXS
ELBOW_UP_WRIST_UP	Band 1	Band 5	Band 9	Band 13
ELBOW_UP_WRIST_DOWN	Band 2	Band 6	Band 10	Band 14
ELBOW_DOWN_WRIST_UP	Band 3	Band 7	Band 11	Band 15
ELBOW_DOWN_WRIST_DOWN	Band 4	Band 8	Band 12	Band 16

The value of the pixel is interpreted according to the instrument. For RAT, 0 means the pixel is not reachable in that configuration, while any other number represents the maximum preload in integer Newtons that can be applied at that point. For all other instruments, 0 means the pixel is not reachable by that instrument in that configuration, while 255 means that the pixel is reachable.

5.2.11 Terrain Map RDR

Terrain models are a high level product which are derived from the XYZ files and the corresponding image files. The terrain models are generated by meshing or triangulating the XYZ data based on the connectivity implied by the pixel ordering or by a volume based surface extraction. The XYZ files can be viewed as a collection of point data while the terrain models take this point data and connect it into a polygonal surface representation. The original image is referenced by the terrain models as a texture map which is used to modulate the surface color of the mesh. In this way the terrain models can be viewed as a surface reconstruction of the ground near the instrument with the mesh data capturing the shape of the surface and the original image, applied as a texture map, capturing the brightness variations of the surface. Specific terrain model formats such as VST, PFB, DEM and others can be viewed as analogous to GIF, TIFF or VICAR in image space in that each represents the data somewhat differently for slightly different purposes.

5.2.11.1 VST Terrain Wedge

The ViSTa (VST) format consists of one terrain model for each wedge (stereo image pair), in a JPL-defined binary format suitable for display by SAP. Each file contains meshes at multiple levels of detail.

5.2.11.2 PFB Terrain Mesh

The Performer Binary (PFB) format facilitates the representation of a terrain surface as polygons, optimized for use by the RSVP tool. The number of polygons at any one time may vary according to site specific features, such as small rocks versus large boulders.

5.2.12 Mosaic RDR

This section discusses the process of mosaicking multiple frames into a single RDR product. The text largely reflects the methods applied by MIPL under OPGS, associating projections with the mosaicking process. It should be noted that these processes can be independent, and that governing methods and software can differ between OPGS and the Athena Pancam and Microscopic Imager Teams under SOAS. For instance, it is possible that OPGS and SOAS software will transform individual images to one of the projections discussed below, without involving any mosaicking. Detailed mathematical descriptions of the mosaic projections and algorithms will be available in a separate paper "Mars Mosaic Projection Algorithms" (not yet available at the time of this writing).

5.2.12.1 Overview of Mosaics in General

Mosaics can be assembled autonomously by tracing a view ray from each mosaic location or pixel into the scene, determining its intersection with a ground plane, and then querying each input image to determine if that point lies within its field of view. In this fashion mosaics containing several hundred images can be assembled for each spectral band in about 3 minutes each. It may be necessary to refine the camera pointing in order to produce accurate mosaics. This requires the determination of the actual azimuth and elevation of each image in order to correct for errors such as gear backlash. One way to do this is to acquire tiepoints between all pairs of overlapping images. Camera pointing commands are then estimated which cause the camera model to map the tiepoints to their correct locations. In some cases this can be accomplished automatically, but in general it requires human intervention to select tiepoints because of nonexistent overlap or changing lighting.

There are many uses for the image mosaics. First is the assembly of small pieces into a larger field of view. This includes tilting the camera model in the Mars coordinate system to model a tilted spacecraft, which should result can in mosaics with a level horizon beginning and ending at Mars north. The science teams can use these products to orient themselves. Another application is to provide to the

rover planning team each Sol a small stereo mosaic which is registered to a fixed reference image. This permits the triangulation of way points for the next Sol's maneuvering.

5.2.12.2 How MIPL Creates Mosaics

The process used by the MIPL software to create mosaics is described below. It consists of several sub-steps. Conceptually, one can think of the process as adjusting the inputs, projecting them down to a surface, and looking at the result from a different point of view (the output projection). In reality, the process is run in reverse for ease of interpolation (this is described below).

- A. *Input Pointing Adjustment* - There are several methods by which improved pointing of the cameras can be determined. The most common method is to pick tiepoints between image pairs and use that in a global function minimization to determine the corrected pointing parameters. Pointing parameters can also be determined manually.

Regardless of method, the result is encapsulated in a "nav" file. A complete description of this file is outside the scope of this SIS, but fundamentally, this file contains, for each image being corrected, the original pointing parameters, and the improved pointing parameters.

Pointing parameters are simply those numbers which represent how the camera is pointing in the rover frame, reduced to available degrees of freedom. These are used as inputs to the kinematics procedures which derive the camera model. Thus for the mast cameras there are two parameters: azimuth and elevation actuator angles. For the MI, there are four: one angle for each joint on the arm. The kinematics procedures take these parameters, combine them with spacecraft kinematic information and camera calibration, and create a camera model describing the input image.

The MIPL procedure exactly duplicates the on-board flight software mechanism for doing this (even using some flight code). Therefore the process is not described in more detail here. Suffice it to say that, in the absence of any change to the pointing, the result is the exact same camera model that the flight software generates and that ends up in the image label.

There is one additional degree of freedom that is added to the MIPL code, however. Analysis of imagery from Spirit especially, showed a slight "twist" in the imagery that was not modeled by the camera model. Therefore an extra pointing parameter, called "twist", was added. This has the effect of taking the final camera model, and rotating it by the specified amount around the A axis (A being one of the CAHV camera model parameters).

Note that this entire process is completely optional; the telemetry camera model can be used as-is.

Regardless of how obtained, the final result is a CAHV, CAHVOR, or CAHVORE camera model that describes the input geometry.

- B. *Output Projection Determination* - The output projection is then determined. The parameters describing the projection are listed in Appendix A, and described in detail in Appendix B. The output projection parameters are determined by analysis of the inputs to give the "best" resulting mosaic, but can be overridden by the user. The determination process is outside the scope of this document; the results are what is important and they are in the label.

- C. *Surface Determination* - A surface model is critical for mosaics. This is a mathematical surface which hopefully matches the actual scene. To the extent that the scene differs from the surface model, distortion and uncorrectable seams can result.

Usually the surface model is a flat plane, with normal pointing upwards. This can be adjusted, however, to better match the scene. Regardless, the results are documented in the SURFACE_MODEL_PARMS group.

There are five potential surface models in the MIPL software: PLANE, SPHERE2, INFINITY, SPHERE1, and SPHERE. To date, only the first two have been used. See SURFACE_MODEL_TYPE in Appendix B for description.

- D. *Computation of Output View Ray* - For each pixel in the output mosaic, a view ray in 3-D space is constructed. How this view ray is constructed depends on the projection type. Below, the pixel is at location (i,j) in 0-based coordinates, with i corresponding to sample and j to line. (0,0) is in the upper-left-hand corner. Capitalized values represent PDS label items from the SURFACE_PROJECTION_PARMS group. Unit and coordinate system conversions are applied as necessary but are not specified here. The coordinate system used is defined by REFERENCE_COORD_SYSTEM_* in SURFACE_PROJECTION_PARMS.
- E. *Projection from Output to Surface* - Once the view ray is determined, it is projected out until it intersects with the surface model. The resulting point in XYZ space is used in the next step. If the ray does not intersect the surface, the point is assumed to be at infinity in the direction the view ray is pointing. Exception: as mentioned above, the Vertical projection will reverse the direction of its view ray; infinity is assumed only if they both miss.

Note that the INFINITY surface model guarantees the ray will miss the surface at all times.

The difference between the SPHERE1 and SPHERE2 models is that, if the ray intersects the spherical surface more than once, SPHERE1 will take the first intersection, while SPHERE2 will take the second. For normal rover situations, SPHERE1 thus roughly models a hill, while SPHERE2 roughly models a crater.

- F. *Projection from Surface to Input* - The XYZ location (or direction for the infinity case) is then back-projected into each input camera model in turn, using the corresponding input camera model. The first input for which the resulting pixel coordinate is inside the image (excluding border pixels which are thrown away) stops the process; that is the image from which the output pixel value is taken.

Note that this has the effect of stacking the images such that the first one in the input list of images "wins". There is no feathering of overlaps; the first image is "on top" of all the others, and an image completely covered by preceding images will not be used at all.

- G. *Interpolation and Storage of the Result* - Finally, a bilinear interpolation is performed on the input image, based on the 4 pixels surrounding the back-projected location. The result of this interpolation is the value of the output pixel.

Bilinear interpolation is optional, and is normally not done when making mosaics of XYZ or Surface Normal (UVW) data.

5.2.12.3 Cylindrical Projection Mosaic

The MIPL method for creating a Cylindrical projection involves computing the azimuth and elevation of the view ray, as follows:

$$\text{azimuth} = i / \text{MAP_RESOLUTION} + \text{START_AZIMUTH}$$

$$\text{elevation} = (\text{ZERO_ELEVATION_LINE} - j) / \text{MAP_RESOLUTION}$$

The view ray emanates from the point PROJECTION_ORIGIN_VECTOR.

Figure 5.2.11.1 shows such a mosaic overlaid onto azimuth and elevation grid lines, with individual frame boundaries superimposed and annotated by number. In this case each pixel represents a fixed angle in azimuth and elevation. Rows are of constant elevation in Mars coordinates. The horizon is level, and columns begin clockwise from Mars north.

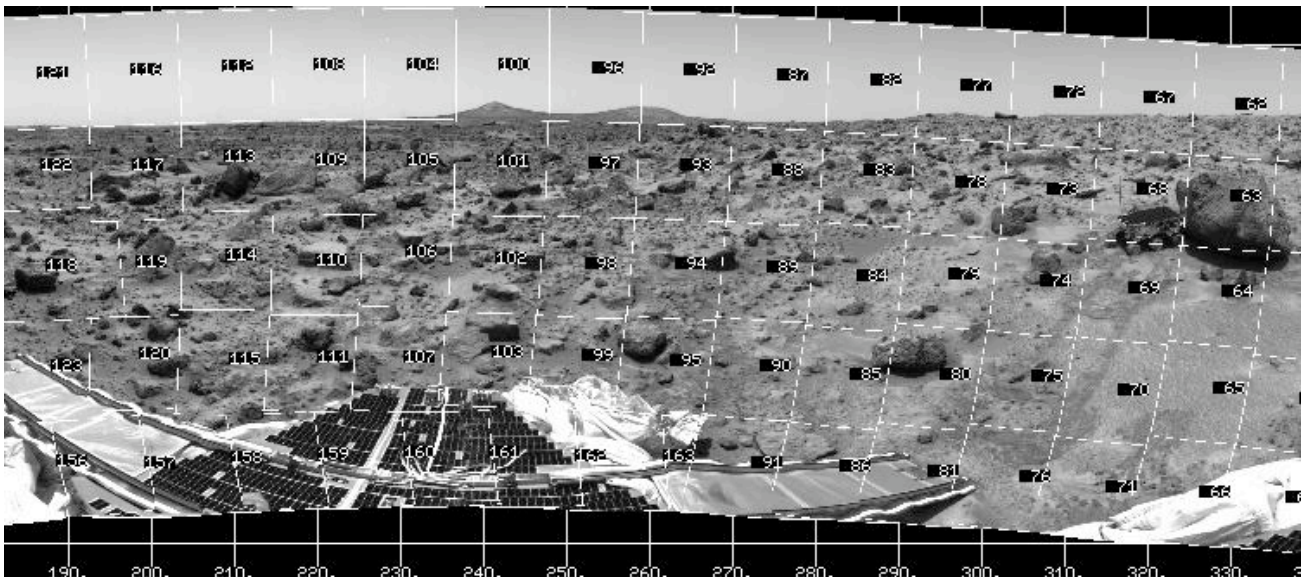

Figure 5.2.11.1 – Cylindrical Projection Mosaic

5.2.12.4 Camera Point Perspective Mosaic

MIPL creates the Camera Point Perspective by using the output camera model (described by the GEOMETRIC_CAMERA_MODEL group in the output mosaic) to project the pixel into space. The origin of the view ray is thus the C point of the camera model, with the ray's direction being determined by the camera model. See Section 5.2.3 and references [Ref 16] through [Ref 25] for the mathematics.

Figure 5.2.11.2 shows a Camera Point Perspective mosaic. It is a perspective projection with horizontal epipolar lines. The mosaic behaves as though the "camera" which acquired the image frames was an instrument with a much larger field of view. For MER, this type of mosaic is in the Rover Frame and is tilted to reflect the position of the rover relative to the horizon.

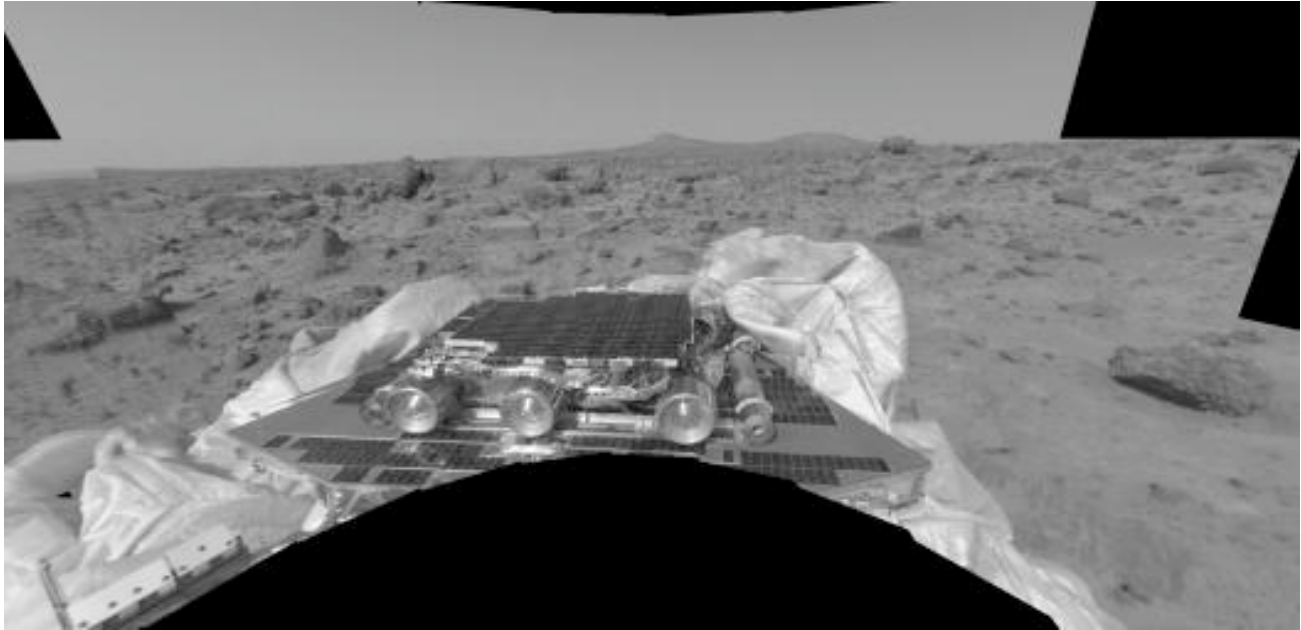

Figure 5.2.11.2 – Camera Point Perspective Mosaic

5.2.12.5 Cylindrical- Perspective Projection Mosaic

At MIPL, this is the most complicated projection to create. Each column *i* in the output mosaic is assigned its own camera model. This is done in several steps:

- 1) Compute initial camera model. This model is a CAHV linearized model derived from the first input to the mosaic, and is described in the GEOMETRIC_CAMERA_MODEL label group.
- 2) The instantaneous field of view of the "central" pixel (at the point where the A vector intersects the image plane) is computed using the formula:

$$\text{ifov} = \text{atan}(1.0 / |(\vec{H} - \vec{A} * (\vec{H} \cdot \vec{A}))|)$$

where the “•” indicates the scalar dot product of the two vectors A and H.

Alternatively, this can be derived from the image size and azimuthal extent (where the azimuths are adjusted by 360 degrees such that the result is minimally positive):

$$\text{ifov} = (\text{STOP_AZIMUTH} - \text{START_AZIMUTH}) / \text{LINE_SAMPLES}$$

- 3) The azimuth of the column is computed:

$$\text{azimuth} = \text{START_AZIMUTH} + i * \text{ifov}$$

- 4) The initial camera model is re-pointed using kinematics as described above under the pointing correction section, using the above azimuth and PROJECTION_ELEVATION. This results in the final camera model for the column.

Note that for MER mastcam cameras (pancam/navcam), the C points of the column camera models describe a ring in space, whose diameter is approximately the baseline between the cameras, whose plane is approximately horizontal in the rover frame, and whose origin is at PROJECTION_ORIGIN_VECTOR. Unfortunately, the MIPL software does not fill in PROJECTION_ORIGIN_VECTOR, thus some information is missing unless knowledge of the kinematics is available. The PROJECTION_ORIGIN_VECTOR may be approximately reconstructed by moving the C point of the initial camera model in a direction normal to the A vector, horizontal in the Rover frame (no rover frame Z component), and toward the center of the mast (to the right for a left eye, to the left for a right eye, if you are sitting at C and looking along A). Move it by a distance equal to half of the stereo pair's baseline (see sections 2.1 and 2.2: 30/2 cm for pancam, 20/2 cm for navcam). This is an approximation but should be correct to within a few centimeters.

Once the camera models have been defined, the mosaic proceeds through each pixel as with the other projections. The view ray is computed as described below (A, H, and V come from the column's camera model):

$$\begin{aligned}
 x_center &= \vec{A} \cdot \vec{H} \\
 y_center &= \vec{A} \cdot \vec{V} \\
 samp &= x_center \\
 line &= y_center + j - PROJECTION_ELEVATION_LINE
 \end{aligned}$$

where the “•” indicates the scalar dot product of two vectors. This (samp,line) coordinate is then projected into space using the column's camera model, and this projection becomes the view ray. The origin of the view ray is the column's C point. See Section 5.2.3 and references [Ref 16] through [Ref 25] for the mathematics of camera models.

Figure 5.2.11.3 shows a Cylindrical-Perspective projection in which a 360 degree view can be viewed in stereo. This is a perspective projection similar to Figure 5.2.11.2 except that the mosaic acts like a pinhole camera which follows the mosaic in azimuth. If the mosaic is generated using Rover coordinates, the horizon will not be level, instead being sinusoidal. This preserves epipolar alignment and allows for better stereo viewing of the panorama. However, for aesthetic reasons, many Cylindrical-Perspective mosaics are created using Site coordinates. In these cases, the horizon will be level, but stereo alignment will be compromised. If the rover is sitting relatively level, the stereo misalignment is small enough that it does not affect normal viewing, so the aesthetic impact of a flat horizon is often considered more important. The REFERENCE_COORD_SYSTEM_NAME label in SURFACE_PROJECTION_PARMS indicates the frame used.

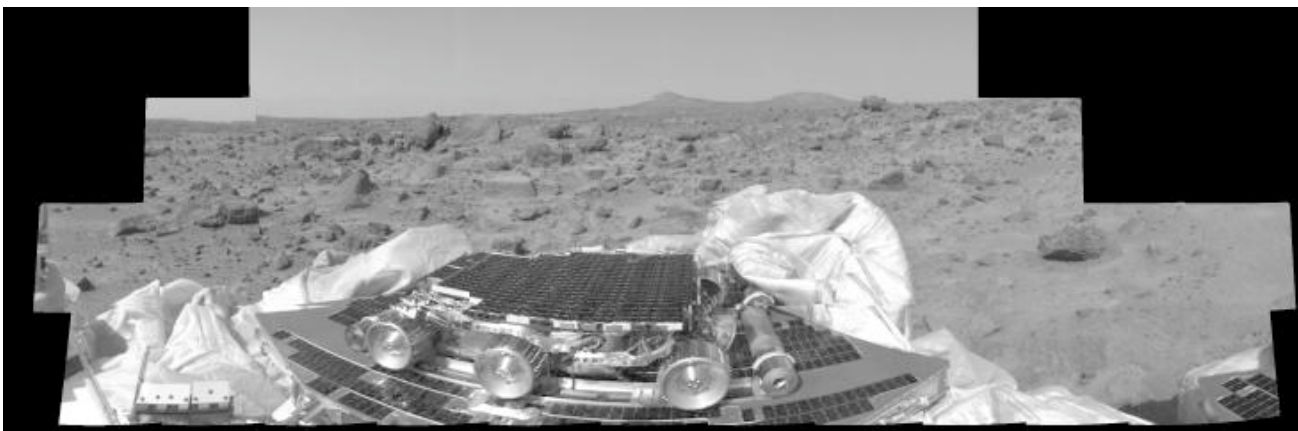

Figure 5.2.11.3 – Cylindrical-Perspective Projection Mosaic

5.2.12.6 Polar Projection Mosaic

MIPL creates the Polar projection by computing the azimuth and elevation of the view ray as follows:

$$\begin{aligned}
 x &= i - \text{SAMPLE_PROJECTION_OFFSET} \\
 y &= \text{LINE_PROJECTION_OFFSET} - j \\
 \text{range} &= \sqrt{x*x + y*y} \\
 \text{elevation} &= \text{range} / \text{MAP_RESOLUTION} - 90 \text{ degrees} \\
 \text{azimuth} &= \text{REFERENCE_AZIMUTH} + (90 \text{ degrees} - \text{atan2}(y, x)) / \text{MAP_RESOLUTION}
 \end{aligned}$$

The view ray emanates from the point PROJECTION_ORIGIN_VECTOR.

Figure 5.2.11.4 shows a Polar projection. Concentric circles represent constant projected elevation. Mars nadir is at the convergent center and the horizon is corrected for lander tilt. North is up.

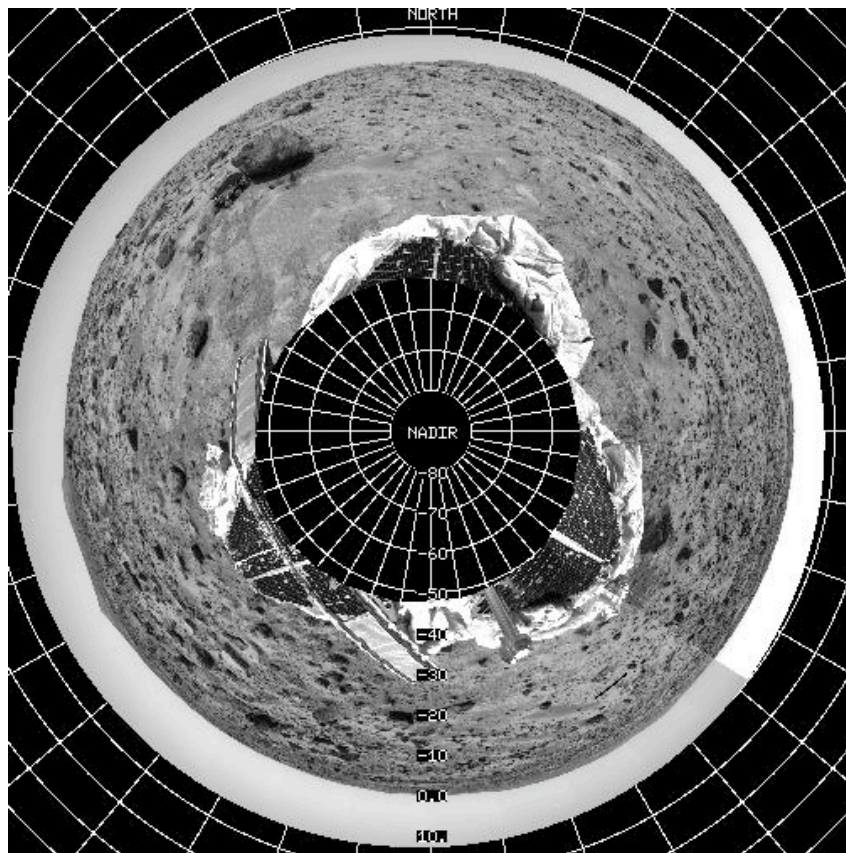

Figure 5.2.11.4 – Polar Projection Mosaic

5.2.12.7 Vertical Projection Mosaic

MIPL creates the Vertical projection as follows:

nl = number of lines in the mosaic (IMAGE object, LINES)
 ns = number of samples in the mosaic (IMAGE object, LINE_SAMPLES)
 $x = (nl/2 - j) * MAP_SCALE$
 $y = (i - ns/2) * MAP_SCALE$

The view ray emanates from $(x, y, 0)$ and points straight down $(0,0,1)$. If the ray misses the surface in step E of Section 5.2.12.2 above, it is changed to point straight up $(0,0,-1)$.

Figure 5.2.11.5 shows a vertical view. It assumes that the field is a plane tangent to the Martian surface with up pointing north. This is not an orthorectified rendering but was found to be useful for rapid initial orientation.

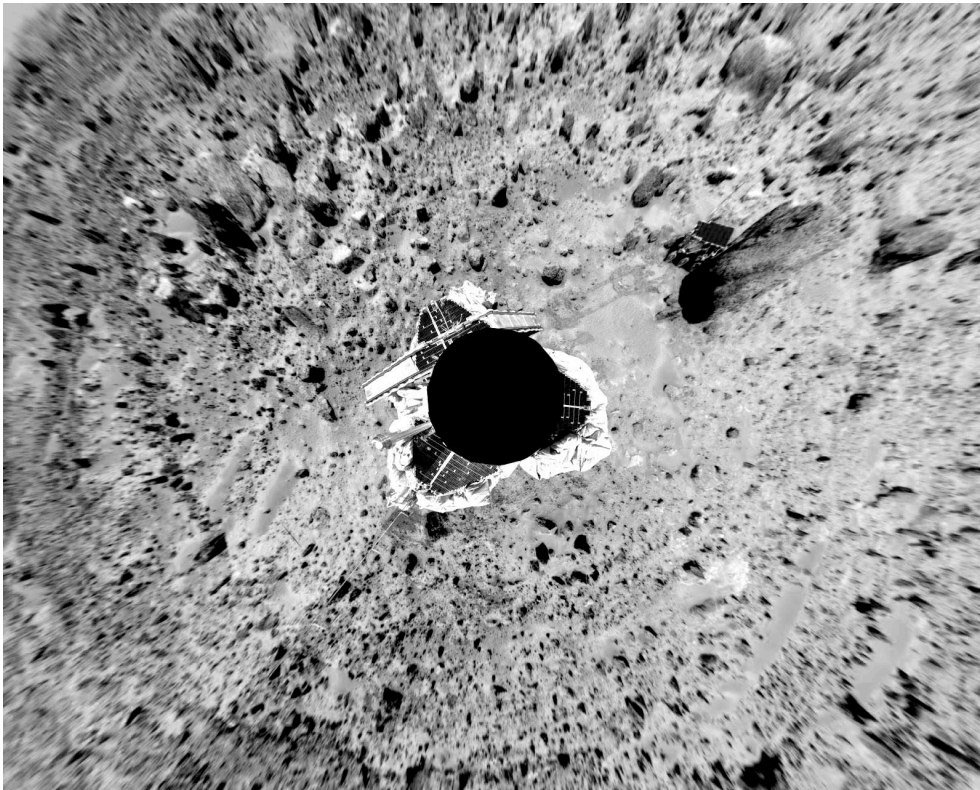

Figure 5.2.11.5 – Vertical Projection Mosaic

5.2.12.8 Orthographic Projection Mosaic

The Orthographic projection is a generalization of the Vertical projection intended primarily for use with MI data. It differs in that an arbitrary axis of projection (as well as X- and Y-axes in the plane of projection) can be specified.

If O is the point specified by the PROJECTION_ORIGIN_VECTOR and $Xhat$ and $Yhat$ are the unit vectors given by PROJECTION_X_AXIS_VECTOR and PROJECTION_Y_AXIS_VECTOR respectively, then an arbitrary point P will have projection coordinates (X,Y) as follows:

$$\vec{X} = (\vec{P} - \vec{O}) \cdot \hat{X}$$

$$\vec{Y} = (\vec{P} - \vec{O}) \cdot \hat{Y}$$

where the “ \cdot ” indicates the scalar dot product of two vectors. PROJECTION_Z_AXIS_VECTOR is the direction of projection; the three vectors form a right-handed orthonormal basis.

All of these quantities must be specified with respect to a single frame defined by the REFERENCE_COORD_SYSTEM_NAME and REFERENCE_COORD_SYSTEM_INDEX. Additional required parameters for the projection are MAP_SCALE, X_AXIS_MINIMUM, X_AXIS_MAXIMUM, Y_AXIS_MINIMUM, and Y_AXIS_MAXIMUM.

5.2.12.9 XYZ Mosaic

Normally mosaics are created using imagery, where each pixel is either a raw or radiometrically corrected intensity value. However, mosaics can also be created using other types of pixels.

An XYZ mosaic contains XYZ values for each pixel in the mosaic rather than intensity values. The inputs to the mosaic program are XYZ files (or individual X, Y, or Z components), and the pixels are interpreted in the same way - as the coordinate of the corresponding pixel in Cartesian space. Like XYZ images, they may consist of a single 3-band file with X, Y, and Z components, or separate 1 band files for each component.

XYZ mosaics can be produced in any of the mosaic projections.

Care must be taken while producing these mosaics to ensure that a consistent coordinate system is used for all the input images. The output mosaic may have only one coordinate system in which the XYZ values are defined.

5.2.12.10 Surface Normal (UVW) Mosaic

Similar in concept to XYZ mosaics, a UVW mosaic is simply a mosaic created from UVW (surface normal) input images. The pixels represent the surface normals at each point. Like Surface Normal (UVW) images, they can be single 3-band files or separate 1-band files for each component.

As with XYZ mosaics, any projection may be used, and all output values must be defined in the same coordinate system.

5.2.13 Anaglyph RDR

A stereo anaglyph is a method of displaying stereo imagery quickly and conveniently using conventional display technology (no special hardware) and red/blue glasses. This is done by displaying the left eye of the stereo pair in the red channel, and displaying the right eye in the green and blue channels. An anaglyph data product simply captures that into a single 3-band color image, which can be displayed using any standard image display program with no knowledge that it is a stereo image.

The red (first) band contains the left eye image, while the green and blue (second and third) bands each contain the right eye image (so the right image is duplicated in the file).

The Anaglyph method can also apply to multi-frame mosaic products. MIPL-generated mosaic Anaglyphs occasionally required some subtle pixel-shifting of the right eye mosaic data to improve the stereo effects. Mosaic Anaglyph products are distinguishable in the Mosaic RDR filename convention (see Section 4.4.2).

6. STANDARDS USED IN GENERATING PRODUCTS

6.1 PDS Standards

The MER Camera Payload EDR data product complies with Planetary Data System standards for file formats and labels, as specified in the PDS Standards Reference [Ref 4]. See Section 3.2.1 for a description of the PDS Label and the specific conventions adopted by MER.

6.2 Time Standards

The EDR PDS label uses keywords containing time values. Each time value standard is defined according to the keyword description. See Appendix B.

6.3 Coordinate Frame Standards

The coordinate systems defined for MER surface operations are listed in Table 6.3 and illustrated in Figure 6.3 below. Refer to the Pointing, Positioning, Phasing and Coordinate Systems document [Ref 6] and the image processing architecture document [Ref 13] for more details.

Table 6.3 - Coordinate Frames Used for MER Surface Operations

Imaging-Related Coordinate Frames		Coordinate Frame Origin	Coordinate Frame Orientation
Name	Label Keyword Value		
Lander Frame (L Frame)	"LANDER_FRAME"	Attached to Lander	Aligned with Lander
Lander Frame, Z Up (L Up Frame)	"LANDER_FRAME_UP"	Attached to Lander	Aligned with Lander, X east, Y north, Z zenith
Mars Body Fixed (MBF)	does not appear in label	Attached to Mars center of Mass	x=equatorial plane, intersects the prime meridian, z= Mars spin axis, points toward the North pole, y completes the right-handed system
Mast Frame	"MAST_FRAME"	Attached to PMA mast head	Aligned with pointing of mast head
Pancam Frame	"PANCAM_FRAME"	Attached to Camera	Aligned with camera pointing
Rover Frame (R Frame)	"ROVER_FRAME"	Attached to Rover	Aligned with Rover
Surface (S _n Frame) (Site Frame)	"SITE_FRAME"	Attached to Surface	North/East/Nadir
Surface, Z Up (S _n Up Frame) (Site Frame, Z Up)	"SITE_FRAME_UP"	Attached to Surface	X east, Y north, Z zenith
Surface Rover (S _R Frame) (Local Level)	"LOCAL_LEVEL_FRAME"	Attached to Rover (coincident with Rover Frame)	North/East/Nadir
Surface Rover, Z Up (S _R Up Frame) (Local Level)	"LOCAL_LEVEL_FRAME_UP"	Attached to Rover (coincident with Rover Frame)	X east, Y north, Z zenith

Imaging-Related Coordinate Frames		Coordinate Frame Origin	Coordinate Frame Orientation
Name	Label Keyword Value		
MI Frame	"MI_FRAME"	Attached to Camera, (aligned with pointing)	Z outward from camera, Y up in image, X completes right hand frame
MI Frame, Z Up	"MI_FRAME_UP"	Attached to Camera, (aligned with pointing)	Z toward camera, Y up in image, X completes right hand frame (Z is negative Z of MI_FRAME, Y is same as in MI_FRAME, X is negative X of MI_FRAME)

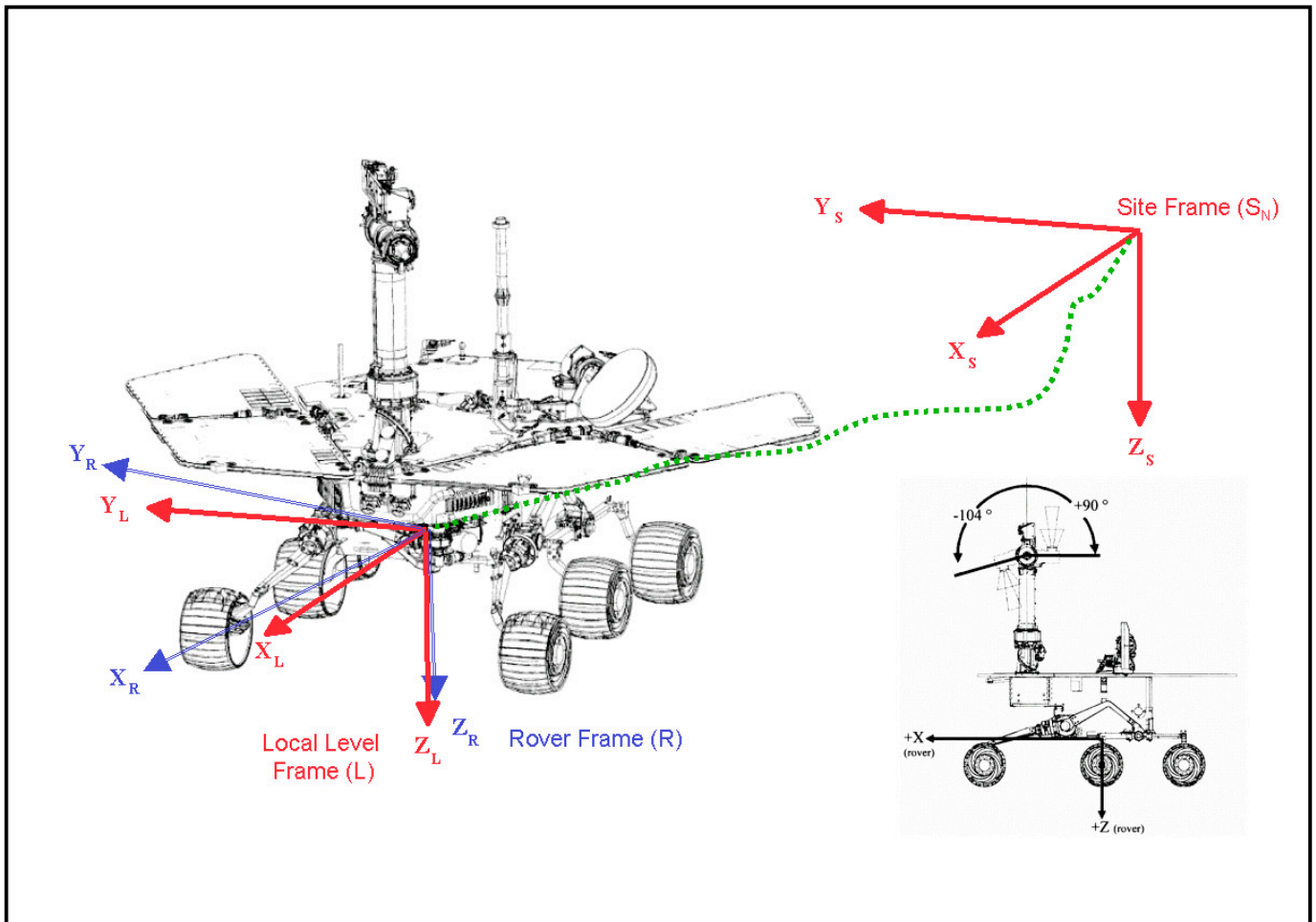

Figure 6.3 - S, S_R and R Coordinate Frames

7. APPLICABLE SOFTWARE

MER Camera Payload downlink processing software is focused on rapid reduction, calibration, and visualization of images in order to make discoveries, to accurately and expeditiously characterize the geologic environment around the rover, and to provide timely input for operational decisions concerning rover navigation and Instrument Deployment Device (IDD) target selection. Key software tools have been developed at Cornell University, at JPL by the MIPL, SSV, and APSS groups, at NASA Ames, and at the USGS/Flagstaff. These tools can also be used to process MI images (see below), as well as Navcam and Hazcam images, which have substantial scientific potential in addition to their operational importance

7.1 Utility Programs

Table 7.1 lists (in no particular order) the primary software tools that will be used to process and manipulate downlinked MER Camera Payload imaging data. All image processing software will be executable by members of the four MER Camera Payload Science Teams on computers in the JPL Science Support Area and will be capable of reading and writing image data in PDS format. The Operations Product Generation System (OPGS) and MIPL will generate EDRs in PDS format and deposit them on their FEI server for transfer to JPL's MER GDS Operations Storage Server (OSS) as rapidly as possible after receipt of telemetry.

Table 7.1 - Key Software Tools for MER Camera Payload Downlink Processing

Name	Description	Primary Development Responsibility
MERTELEMPROC	Fetches the image Standard Formatted Data Unit (SFDU) records from MER Data Product (DP) files, reconstructing the image file from the telemetry data into a PDS-labelled image EDR data product. VICAR code.	Payam Zamani (JPL / MIPL)
SOAS Software	Developed by Athena Pancam Science Team. IDL code: <ul style="list-style-type: none"> • PANCAL – Radiometric processing and calibration of Pancam (or MI, Navcam, or Hazcam) images. • PANSPEC – Simple geometric (x,y) registration of Pancam (or MI, Navcam, or Hazcam) images and initial multispectral analyses of data (cal target analysis, color ratios, spectrum extraction, etc.). • PANMAP – Simple and rapid pointing-based mosaic generation using raw EDRs or calibrated images from Pancam (or MI, Navcam, or Hazcam). 	Jim Bell (Cornell University)
SOAS Software	Developed by MI Science Team. ISIS code: <ul style="list-style-type: none"> • PDS2ISIS – Converts MI data in PDS format to ISIS format. 	Ken Herkenhoff (USGS, Flagstaff)
Mars Program Suite	Rapid ("quick look") correlator-based mosaic generation using raw EDRs or calibrated images from Pancam, MI, Navcam, and/or Hazcam). VICAR code: <ul style="list-style-type: none"> • MARSCAHV – Generates a geometrically corrected version of the EDR, applying the C, A, H and V camera model vectors. • MARSRAD – Generates a radiometrically corrected image from a single input EDR. • MARSJPLSTEREO – Generates a disparity map from a stereo pair of input EDRs, applying a 1-D correlator (fast). • MARSCOR3 – Generates a disparity map from a stereo pair of input EDRs, applying a 2-D correlator (more robust). 	Bob Deen (JPL / MIPL)

Name	Description	Primary Development Responsibility
	<ul style="list-style-type: none"> • MARSXYZ – Generates an XYZ image from an input disparity map. • MARSRANGE – Generates an Range image from an input XYZ map. • MARSREACH – Generates an IDD reachability map from an input XYZ map. • MARSUVW - Generates a Surface Normal image, wherein XYZ is computed normal to the surface. • MARSROUGH - Generates a Surface Roughness map. • MARSMAP – Generates a Cylindrical, Polar or Vertical projection mosaic from a list of input EDRs. • MARSMOS – Produces pinhole camera mosaics using uncorrected input images and CAHVOR camera model. • MARSMCAULEY – Generates a combination Cylindrical-Perspective projection mosaic from a list of input EDRs. • MARSTIE – Generates pointing corrections (tiepoint file) from an overlapping set of input EDRs. • MARSNAV – Generates an updated azimuth and elevation file based on comparison with existing image data that can be directly compared. • MICA – Interactive mosaic correction. 	
SUMMITT	<p>Performs stereo processing to create XYZ images and 3D polygon mesh terrain models.:</p> <ul style="list-style-type: none"> • do_tmerge – A script tool that calls lower-level code to generate terrain triangles, or “wedges”, in VISTA format suitable for ingestion by SAP software. • do_mesh – A script tool that calls lower-level code to merge terrain wedges into a single surface fitted terrain mesh in Performer Binary format suitable for ingestion by RSVP software. 	John Wright (JPL / MIPL)
Stereo-Pipeline	Rapid generation of 3-D polygon mesh models of the terrain using raw (EDR) or calibrated stereo images from Pancam, MI, Navcam, and/or Hazcam.	Larry Edwards (NASA / Ames)
Viz	Visualization and planning software for interrogation and analysis of 3-D terrain models. C++ code.	Larry Edwards (NASA / Ames)
APSS / SAP	Visualization and planning software for creation of science products and candidate observations for presentation at SOWG meetings, and then Sol activity list at end of SOWG meetings. Java code.	Jeff Norris (JPL)
APSS / RSVP	Visualization, planning, and sequence generation software for use by Sequence Team to create Sol sequences based on activity lists generated by SAP during SOWG. Java, C and C++ code.	Brian Cooper (JPL)
VPP	Rapid generation of data visualization products for creation of science products and candidate observations for presentation at SOWG meetings and for E/PO and press release activities. VICAR code.	Eric DeJong (JPL / SSV)
SOAS software	Photogrammetric and cartographic processing of calibrated Pancam, MI, Navcam, and/or Hazcam images, for publication-quality science analysis and archiving. ISIS and SOCET SET code.	Randy Kirk (USGS / Flagstaff)

7.2 Applicable PDS Software Tools

PDS-labeled images and tables can be viewed with the program NASAView, developed by the PDS and available for a variety of computer platforms from the PDS web site

<http://pdsproto.jpl.nasa.gov/Distribution/license.html>. There is no charge for NASAView.

7.3 Software Distribution and Update Procedures

The FEI distribution tool and Mars Image Processing Program Suite are available to researchers and academic institutions. Refer to the MIPL Web site at <http://www-mipl.jpl.nasa.gov> for contact information. FEI is described in detail at <http://www-mipl.jpl.nasa.gov/MDMS>.

APPENDIX A - MER Camera "Combined" EDR/RDR PDS Label

- KEY: **X** = Keyword not present in PDS or VICAR label.
. = Keyword present in PDS and VICAR labels. For RDRs, keyword matches source image. If not in source image, then keyword is not present.
m = Keyword present in PDS and VICAR labels, value **MODIFIED** from source image.
o = Keyword **OPTIONAL** in PDS label, present only if relevant. Examples are the camera model vector keywords MODEL_COMPONENT_n in the Group GEOMETRIC_CAMERA_MODEL.
p = Keyword present in **PDS** label only, and not present in VICAR label per se.
s = Keyword present in PDS label only, and limited to only **SCIENCE** RDRs produced by Athena Pancam Team and/or Athena MI Team.

PDS Label Keyword / Comment & Example Value	Ground EDR		Flight EDR		RDR															
	CCD Test Data	GSE Calibr.	Flat Field Files	Ops Field Files	Sci (Pancam)	Sci (MI)	Inverse Lut	Rad Correction	Linearized XYZ	Range	Surf. Normal	Slope	IPP Reach	Mosaic (CY)	Mosaic (PR)	Mosaic (CP)	Mosaic (OR)	Mosaic (ORT)		
1 PDS_VERSION_ID = PDS3	p	p	p	p	p	p	p	p	p	p	p	p	p	p	p	p	p	p	p	
2																				
3 /* FILE DATA ELEMENTS */	p	p	p	p	p	p	p	p	p	p	p	p	p	p	p	p	p	p	p	
4																				
5 RECORD_TYPE = FIXED_LENGTH	p	p	p	p	p	p	p	p	p	p	p	p	p	p	p	p	p	p	p	
6 RECORD_BYTES = 2048	p	p	p	p	p	p	p	p	p	p	p	p	p	p	p	p	p	p	p	
7 FILE_RECORDS = 1038	p	p	p	p	p	p	p	p	p	p	p	p	p	p	p	p	p	p	p	
8 LABEL_RECORDS = 8	p	p	p	p	p	p	p	p	p	p	p	p	p	p	p	p	p	p	p	
9																				
10 /* POINTERS TO DATA OBJECTS */	p	p	p	p	p	p	p	p	p	p	p	p	p	p	p	p	p	p	p	
11																				
12 ^IMAGE_HEADER = 9	X	p	p	p	p	p	p	p	p	p	p	p	p	p	p	p	p	p	p	
13 ^IMAGE = 15	p	p	p	p	p	p	p	p	p	p	p	p	p	p	p	p	p	p	p	
14																				
15 /* IDENTIFICATION DATA ELEMENTS */	X	p	p	p	p	p	p	p	p	p	p	p	p	p	p	p	p	p	p	
16																				
17 DATA_SET_ID = "MER1-M-PANCAM-2-EDR-V1.0"	X	m	m	m	m	m	m	m	m	m	m	m	m	m	m	
18 DATA_SET_NAME = "MARS EXPLORATION ROVER 1 PANORAMIC CAMERA V1.0"	X	X	X	X	X	X	
19 COMMAND_SEQUENCE_NUMBER = 33	X	X	X	X	X	X	X	
20 FRAME_ID = "RIGHT"	X	X	m	m	m	m	m	
21 FRAME_TYPE = STEREO	X	X	m	m	m	m	m	
22 GEOMETRY_PROJECTION_TYPE = RAW	X	X	m	X	X	X	X	X	
23 IMAGE_ID = "44160017"	X	X	X	X	X	X	X	
24 IMAGE_TYPE = REGULAR	X	X	X	X	X	X	
25 INSTRUMENT_HOST_ID = "MER1"	X	X	m	m	m	m	m	
26 INSTRUMENT_HOST_NAME = "MARS EXPLORATION ROVER 1"	X	m	m	m	m	m	
27 INSTRUMENT_ID = "PANCAM_RIGHT"	X	X	m	m	m	m	m	
28 INSTRUMENT_NAME = "PANORAMIC CAMERA RIGHT"	X	m	m	m	m	m	
29 INSTRUMENT_SERIAL_NUMBER = 54	X	X	X	X	X	X	
30 INSTRUMENT_TYPE = "IMAGING CAMERA"	X	m	m	m	m	m	
31 INSTRUMENT_VERSION_ID = "FM"	X	X	X	X	X	X	
32 LOCAL_TRUE_SOLAR_TIME = "12:22:24 PM"	X	X	X	X	X	X	X	
33 MAGNET_ID = "NULL"	X	X	X	X	X	X	X	
34 MISSION_NAME = "MARS EXPLORATION ROVER"	X	m	m	m	m	m	
35 MISSION_PHASE_NAME = "PRIMARY MISSION"	X	X	X	X	X	X	X	
36 OBSERVATION_ID = "301989888"	X	X	X	X	X	X	X	
37 PLANET_DAY_NUMBER = 39	X	X	X	X	X	X	X	
38 PRODUCER_INSTITUTION_NAME = "MULTIMISSION IMAGE PROCESSING SUBSYSTEM, JET PROPULSION LAB"	X	m	m	m	m	m	m	m	m	m	m	m	m	m	m	
39 PRODUCT_CREATION_TIME = 2004-06-04T08:39:29.000	X	m	m	m	m	m	
40 PRODUCT_ID = "1P876293673EDR411100171L2M1"	X	m	m	m	m	m	m	m	m	m	m	m	m	m	m	
41 PRODUCT_VERSION_ID = "V2.0 D-22846"	X	m	m	m	m	m	

PDS Label Keyword / Comment & Example Value			Ground		Flight		RDR																			
			EDR	EDR	EDR	EDR	CCD Test Data	GSE Calibr.	Flat Field Files	Obs (all Instr.)	Sci (Pancam)	Sci (MIM)	Inverse LUT	Rad Correction	Linearized	Distort	Range	Surf Normal	Slope	IPP Reach	Mosaic (C/L)	Mosaic (P/L)	Mosaic (C/R)	Mosaic (P/R)	Mosaic (O/L)	Mosaic (O/R)
42	RELEASE_ID	= "0001"	X	.	.	.	m	m	m	m	m	m	m	m	m	m	m	m	m	m	m	m	m	m	m	m
43	ROVER_MOTION_COUNTER	= (1, 2, 0, 0, 0)	X	X	X	X	X	X	X	X
44	ROVER_MOTION_COUNTER_NAME	= (SITE, DRIVE, IDD, PMA, HGA)	X	X	X	X	X	X	X	X
45	SEQUENCE_ID	= "p0171"	X	X	X	X	X	X	X	X
46	SEQUENCE_VERSION_ID	= "2"	X	X	X	X	X	X	X	X
47	SOLAR_LONGITUDE	= 102.844	X	X	X	X	X	X	X	X
48	SPACECRAFT_CLOCK_CNT_PARTITION	= 1	X	X	X	X	X	X	X	X
49	SPACECRAFT_CLOCK_START_COUNT	= "4876293673.256"	X	m	m	m	m	m	m
50	SPACECRAFT_CLOCK_STOP_COUNT	= "4876293679.381"	X	m	m	m	m	m	m
51	START_TIME	= 2004-01-28T20:27:48.049	X	m	m	m	m	m	m
52	STOP_TIME	= 2004-01-28T20:27:48.280	X	m	m	m	m	m	m
53	TARGET_NAME	= MARS	X	m	m	m	m	m	m
54	TARGET_TYPE	= PLANET	X	m	m	m	m	m	m
55																										
56	/* TELEMETRY DATA ELEMENTS */			X	X	X	X	X	X	X	X
57																										
58	APPLICATION_PROCESS_ID	= 22	X	X	X	X	X	X	X	X
59	APPLICATION_PROCESS_NAME	= "PANCAM RIGHT"	X	X	X	X	X	X	X	X
60	APPLICATION_PROCESS_SUBTYPE_ID	= 0	X	X	X	X	X	X	X	X
61	EARTH_RECEIVED_START_TIME	= 2004-01-28T22:06:00.901	X	X	X	X	X	X	X	X
62	EARTH_RECEIVED_STOP_TIME	= 2004-01-28T22:06:04.018	X	X	X	X	X	X	X	X
63	EXPECTED_PACKETS	= "N/A"	X	X	X	X	X	X	X	X
64	PACKET_MAP_MASK	= "N/A"	X	X	X	X	X	X	X	X
65	RECEIVED_PACKETS	= "N/A"	X	X	X	X	X	X	X	X
66	SPICE_FILE_NAME	= "chronos.mer"	X	X	X	X	X	X	X	X
67	TELEMETRY_PROVIDER_ID	= "SSW MER_DP"	X	X	X	X	X	X	X	X
68	TELEMETRY_SOURCE_NAME	= "022_001_p1001-002-0001_005_0126467896-255.dat"	X	X	X	X	X	X	X	X
69	TELEMETRY_SOURCE_TYPE	= "DATA PRODUCT"	X	X	X	X	X	X	X	X
70																										
71	/* HISTORY DATA ELEMENTS */			X	p	X	X	X	X	X	X
72																										
73	SOFTWARE_NAME	= MERTELEMPROC	X	X	X	X	X	X	X
74	SOFTWARE_VERSION_ID	= "V1.24.46"	X	X	X	X	X	X	X
75	PROCESSING_HISTORY_TEXT	= "CODMAC LEVEL 1 TO LEVEL 2 CONVERSION VIA JPL/MIPL MERTELEMPROC"	X	X	X	X	X	X	X
76																										
77	/* CAMERA_MODEL DATA ELEMENTS */			X	X	X	p	X	X	X	X
78																										
79	GROUP	= GEOMETRIC_CAMERA_MODEL	X	X	X	.	o	X	X	X
80	SOLUTION_ID	= "mipl_rgd_sol3nav_5"	X	X	X	X	o	o	o	o	o	o	o	o	o	o	o	o	o	X	o	o	X	X	X	
81	CALIBRATION_SOURCE_ID	= "59"	X	X	X	m	o	X	X	X
82	MODEL_DESC	= "GEOMETRIC_CM.TXT"	X	X	X
83	MODEL_TYPE	= CAHVORE	X	X	X	m	o	X	X	X
84	MODEL_COMPONENT_ID	= ("C", "A", "H", "V", "O", "R", "E", "T", "P")	X	X	X	m	o	X	X	X
85	MODEL_COMPONENT_NAME	= (CENTER, AXIS, HORIZONTAL, VERTICAL, OPTICAL, RADIAL, ENTRANCE, MTYPE, MPARAM)	X	X	X	m	o	X	X	X
86	MODEL_COMPONENT_1	= (0.0230152, -0.076101, 0.874005)	X	X	o	o	o	o	o	o	o	o	o	o	o	o	o	o	o	X	m	o	X	X	X	
87	MODEL_COMPONENT_2	= (0.0602658, 0.945477, -0.304335)	X	X	o	o	o	o	o	o	o	o	o	o	o	o	o	o	o	X	m	o	X	X	X	
88	MODEL_COMPONENT_3	= (1011.61, 62.6302, -20.1324)	X	X	o	o	o	o	o	o	o	o	o	o	o	o	o	o	o	X	m	o	X	X	X	
89	MODEL_COMPONENT_4	= (7.72579, -183.499, -995.739)	X	X	o	o	o	o	o	o	o	o	o	o	o	o	o	o	o	X	m	o	X	X	X	
90	MODEL_COMPONENT_5	= (0.0602619, 0.945474, -0.304348)	X	X	o	o	o	o	o	o	o	o	o	o	o	o	o	o	o	X	m	o	X	X	X	
91	MODEL_COMPONENT_6	= (0.0, -0.001377, -0.027648)	X	X	o	o	o	o	o	o	o	o	o	o	o	o	o	o	o	X	m	o	X	X	X	
92	MODEL_COMPONENT_7	= (0.0, -0.001356, -0.027693)	X	X	o	o	o	o	o	o	o	o	o	o	o	o	o	o	o	X	m	o	X	X	X	
93	MODEL_COMPONENT_8	= 3.0	X	X	o	o	o	o	o	o	o	o	o	o	o	o	o	o	o	X	m	o	X	X	X	
94	MODEL_COMPONENT_9	= 0.27741	X	X	o	o	o	o	o	o	o	o	o	o	o	o	o	o	o	X	m	o	X	X	X	

PDS Label Keyword / Comment & Example Value			Ground		Flight		RDR																				
			EDR	EDR	EDR	EDR	CCD Test Data	GSE Calibr.	Flat Field Files	Ops (all Instr.)	Sci (Pancam)	Sci (MIM)	Inverse LUT	Rad Correction	Linearized	Distortion	XYZ	Range	Surf Normal	Slope	Rough	IDD Reach	Mosaic (Cyl)	Mosaic (PLR)	Mosaic (C/P)	Mosaic (R/O)	Mosaic (R/T)
95	FILTER_NAME	= PANCAM_L2_753NM	X	X	X	X	X	X	X	X
96	REFERENCE_COORD_SYSTEM_NAME	= ROVER_FRAME	X	X	m	X	m	o	X	X	X
97	REFERENCE_COORD_SYSTEM_INDEX	= (1, 2, 0, 0, 0)	X	X	m	X	m	o	X	X	X
98	REFERENCE_COORD_SYSTEM_SOLN_ID	= "mipl_rgd_sol3nav_5"	X	X	X	X	o	o	o	o	o	o	o	o	o	o	o	o	o	o	o	X	o	o	X	X	X
99	END_GROUP	= GEOMETRIC_CAMERA_MODEL	X	X	X	.	o	X	X	X
100																											
101	/* COORDINATE SYSTEM STATE: ROVER */			X	X	p	p	p	p	p	p	p	p	p	p	p	p	p	p	p	p	o	o	o	o	o	
102																											
103	GROUP	= ROVER_COORDINATE_SYSTEM	X	X	o	o	o	o	o	
104	SOLUTION_ID	= "mipl_rgd_sol3nav_5"	X	X	X	X	o	o	o	o	o	o	o	o	o	o	o	o	o	o	o	o	o	o	o	o	
105	COORDINATE_SYSTEM_NAME	= ROVER_FRAME	X	X	o	o	o	o	o	
106	COORDINATE_SYSTEM_INDEX	= (1, 2, 0, 0, 0)	X	X	o	o	o	o	o	
107	COORDINATE_SYSTEM_INDEX_NAME	= (SITE, DRIVE, IDD, PMA, HGA)	X	X	o	o	o	o	o	
108	ORIGIN_OFFSET_VECTOR	= (0.0230152, -0.076101, 0.874005)	X	X	o	o	o	o	o	
109	ORIGIN_ROTATION_QUATERNION	= (0.922297, -0.0165226, -0.0413094, 0.382304)	X	X	o	o	o	o	o	
110	POSITIVE_AZIMUTH_DIRECTION	= CLOCKWISE	X	X	o	o	o	o	o	
111	POSITIVE_ELEVATION_DIRECTION	= UP	X	X	o	o	o	o	o	
112	QUATERNION_MEASUREMENT_METHOD	= FINE	X	X	o	o	o	o	o	
113	REFERENCE_COORD_SYSTEM_NAME	= SITE_FRAME	X	X	o	o	o	o	o	
114	REFERENCE_COORD_SYSTEM_INDEX	= 1	X	X	o	o	o	o	o	
115	REFERENCE_COORD_SYSTEM_SOLN_ID	= "mipl_rgd_sol3nav_5"	X	X	X	X	o	o	o	o	o	o	o	o	o	o	o	o	o	o	o	o	o	o	o	o	
116	END_GROUP	= ROVER_COORDINATE_SYSTEM	X	X	o	o	o	o	o	
117																											
118	/* COORDINATE SYSTEM STATE: LOCAL LEVEL */			X	X	X	X	X	p	p	p	p	p	p	p	p	p	p	p	p	p	o	o	o	o	o	
119																											
120	GROUP	= LOCAL_LEVEL_COORDINATE_SYSTEM	X	X	X	X	o	o	o	o	o	o	o	o	o	o	o	o	o	o	o	o	o	o	o	o	
121	SOLUTION_ID	= "mipl_rgd_sol3nav_5"	X	X	X	X	o	o	o	o	o	o	o	o	o	o	o	o	o	o	o	o	o	o	o	o	
122	COORDINATE_SYSTEM_NAME	= LOCAL_LEVEL_FRAME	X	X	X	X	o	o	o	o	o	o	o	o	o	o	o	o	o	o	o	o	o	o	o	o	
123	COORDINATE_SYSTEM_INDEX	= (1, 2, 0, 0, 0)	X	X	X	X	o	o	o	o	o	o	o	o	o	o	o	o	o	o	o	o	o	o	o	o	
124	COORDINATE_SYSTEM_INDEX_NAME	= (SITE, DRIVE, IDD, PMA, HGA)	X	X	X	X	o	o	o	o	o	o	o	o	o	o	o	o	o	o	o	o	o	o	o	o	
125	ORIGIN_OFFSET_VECTOR	= (0.0230152, -0.076101, 0.874005)	X	X	X	X	o	o	o	o	o	o	o	o	o	o	o	o	o	o	o	o	o	o	o	o	
126	ORIGIN_ROTATION_QUATERNION	= (0.922297, -0.0165226, -0.0413094, 0.382304)	X	X	X	X	o	o	o	o	o	o	o	o	o	o	o	o	o	o	o	o	o	o	o	o	
127	POSITIVE_AZIMUTH_DIRECTION	= CLOCKWISE	X	X	X	X	o	o	o	o	o	o	o	o	o	o	o	o	o	o	o	o	o	o	o	o	
128	POSITIVE_ELEVATION_DIRECTION	= UP	X	X	X	X	o	o	o	o	o	o	o	o	o	o	o	o	o	o	o	o	o	o	o	o	
129	REFERENCE_COORD_SYSTEM_NAME	= SITE_FRAME	X	X	X	X	o	o	o	o	o	o	o	o	o	o	o	o	o	o	o	o	o	o	o	o	
130	REFERENCE_COORD_SYSTEM_INDEX	= 1	X	X	X	X	o	o	o	o	o	o	o	o	o	o	o	o	o	o	o	o	o	o	o	o	
131	REFERENCE_COORD_SYSTEM_SOLN_ID	= "mipl_rgd_sol3nav_5"	X	X	X	X	o	o	o	o	o	o	o	o	o	o	o	o	o	o	o	o	o	o	o	o	
132	END_GROUP	= LOCAL_LEVEL_COORDINATE_SYSTEM	X	X	X	X	o	o	o	o	o	o	o	o	o	o	o	o	o	o	o	o	o	o	o	o	
133																											
134	/* COORDINATE SYSTEM STATE: SITE */			X	X	X	X	X	p	p	o	o	o	o	o	o	o	o	o	o	o	o	o	o	o	o	
135																											
136	GROUP	= SITE_COORDINATE_SYSTEM	X	X	X	X	o	o	o	o	o	o	o	o	o	o	o	o	o	o	o	o	o	o	o	o	
137	SOLUTION_ID	= "mipl_rgd_sol3nav_5"	X	X	X	X	o	o	o	o	o	o	o	o	o	o	o	o	o	o	o	o	o	o	o	o	
138	COORDINATE_SYSTEM_NAME	= SITE_FRAME	X	X	X	X	o	o	o	o	o	o	o	o	o	o	o	o	o	o	o	o	o	o	o	o	
139	COORDINATE_SYSTEM_INDEX	= (1, 2, 0, 0, 0)	X	X	X	X	o	o	o	o	o	o	o	o	o	o	o	o	o	o	o	o	o	o	o	o	
140	COORDINATE_SYSTEM_INDEX_NAME	= (SITE, DRIVE, IDD, PMA, HGA)	X	X	X	X	o	o	o	o	o	o	o	o	o	o	o	o	o	o	o	o	o	o	o	o	
141	ORIGIN_OFFSET_VECTOR	= (0.0230152, -0.076101, 0.874005)	X	X	X	X	o	o	o	o	o	o	o	o	o	o	o	o	o	o	o	o	o	o	o	o	
142	ORIGIN_ROTATION_QUATERNION	= (0.922297, -0.0165226, -0.0413094, 0.382304)	X	X	X	X	o	o	o	o	o	o	o	o	o	o	o	o	o	o	o	o	o	o	o	o	
143	POSITIVE_AZIMUTH_DIRECTION	= CLOCKWISE	X	X	X	X	o	o	o	o	o	o	o	o	o	o	o	o	o	o	o	o	o	o	o	o	
144	POSITIVE_ELEVATION_DIRECTION	= UP	X	X	X	X	o	o	o	o	o	o	o	o	o	o	o	o	o	o	o	o	o	o	o	o	
145	REFERENCE_COORD_SYSTEM_NAME	= SITE_FRAME	X	X	X	X	o	o	o	o	o	o	o	o	o	o	o	o	o	o	o	o	o	o	o	o	
146	REFERENCE_COORD_SYSTEM_INDEX	= 1	X	X	X	X	o	o	o	o	o	o	o	o	o	o	o	o	o	o	o	o	o	o	o	o	
147	REFERENCE_COORD_SYSTEM_SOLN_ID	= "mipl_rgd_sol3nav_5"	X	X	X	X	o	o	o	o	o	o	o	o	o	o	o	o	o	o	o	o	o	o	o	o	
148	END_GROUP	= SITE_COORDINATE_SYSTEM	X	X	X	X	o	o	o	o	o	o	o	o	o	o	o	o	o	o	o	o	o	o	o	o	

PDS Label Keyword / Comment & Example Value	Ground		Flight		RDR																		
	EDR	EDR	EDR	EDR	CCD Test Data	GSE Calibr.	Flat Field Files	Obs (all Instr.)	Sci (Pancam)	Sci (M/I)	Inverse LUT	Rad Correction	Linearized	Distort	Range	Surf Normal	Surf Rough	Slope	IDD Reach	Mosaic (C/L)	Mosaic (P/R)	Mosaic (C/R)	Mosaic (W/R)

149																										
150	/* ARTICULATION DEVICE STATE: HIGH GAIN ANTENNA */																									
151																										
152	GROUP	= HGA_ARTICULATION_STATE	X	X
153	SOLUTION_ID	= "mipl_rgd_sol3nav_5"	X	X	X	X	X	o	o	o	o	o	o	o	o	o	o	o	o	o	o	o	o	o	o	o
154	ARTICULATION_DEVICE_ID	= "HGA"	X	X
155	ARTICULATION_DEVICE_NAME	= "HIGH GAIN ANTENNA"	X	X
156	ARTICULATION_DEVICE_ANGLE	= (0.0230152 <rad>, -0.076101 <rad>)	X	X
157	ARTICULATION_DEVICE_ANGLE_NAME	= (AZIMUTH, ELEVATION)	X	X
158	END_GROUP	= HGA_ARTICULATION_STATE	X	X
159																										
160	/* ARTICULATION DEVICE STATE: FILTER */																									
161																										
162	GROUP	= FILTER_ARTICULATION_STATE	X	X
163	ARTICULATION_DEVICE_ID	= "FILTER"	X	X
164	ARTICULATION_DEVICE_NAME	= "FILTER ACTUATORS"	X	X
165	ARTICULATION_DEV_POSITION	= (2, 3, 0)	X	X
166	ARTICULATION_DEV_POSITION_ID	= ("PANCAM_L2_753NM", "PANCAM_R3_803NM", "NONE")	X	X
167	ARTICULATION_DEV_POSITION_NAME	= ("LEFT PANCAM FILTER", "RIGHT PANCAM FILTER", "MI DUST COVER")	X	X
168	END_GROUP	= FILTER_ARTICULATION_STATE	X	X
169																										
170	/* ARTICULATION DEVICE STATE: INSTRUMENT DEPLOYMENT DEVICE */																									
171																										
172	GROUP	= IDD_ARTICULATION_STATE	X	X
173	ARTICULATION_DEVICE_ID	= "IDD"	X	X
174	ARTICULATION_DEVICE_NAME	= "INSTRUMENT DEPLOYMENT DEVICE"	X	X
175	ARTICULATION_DEVICE_ANGLE	= (0.0230152 <rad>, -0.076101 <rad>, 0.874005 <rad>, 9.4095 <rad>, 0.3467 <rad>, 0.922297 <rad>, 0.0165226 <rad>, -0.0413094 <rad>, 0.38230 <rad>, 0.456 <rad>)	X	X
176	ARTICULATION_DEVICE_ANGLE_NAME	= ("JOINT 1 AZIMUTH-ENCODER", "JOINT 2 ELEVATION-ENCODER", "JOINT 3 ELBOW-ENCODER", "JOINT 4 WRIST-ENCODER", "JOINT 5 TURRET-ENCODER", "JOINT 1 AZIMUTH-POTENTIOMETER", "JOINT 2 ELEVATION-POTENTIOMETER", "JOINT 3 ELBOW-POTENTIOMETER", "JOINT 4 WRIST-POTENTIOMETER", "JOINT 5 TURRET-POTENTIOMETER")	X	X
177	ARTICULATION_DEVICE_MODE	= STOWED	X	X
178	ARTICULATION_DEVICE_TEMP	= (0.922297 <degC>, -0.0165226 <degC>)	X	X
179	ARTICULATION_DEVICE_TEMP_NAME	= ("AZIMUTH JOINT 1", "TURRET JOINT 5")	X	X
180	ARTICULATION_DEV_INSTRUMENT_ID	= "MB"	X	X
181	ARTICULATION_DEV_VECTOR	= (1.23456, 3.4567, 23.456)	X	X
182	ARTICULATION_DEV_VECTOR_NAME	= GRAVITY	X	X
183	CONTACT_SENSOR_STATE	= ("NO CONTACT", "NO CONTACT", "NO CONTACT", "NO CONTACT", "NO CONTACT", "NO CONTACT", "NO CONTACT", "NO CONTACT", OPEN, CONTACT)	X	X
184	CONTACT_SENSOR_STATE_NAME	= ("MI SWITCH 1", "MI SWITCH 2", "RAT SWITCH 1", "RAT SWITCH 2", "MB SWITCH 1", "MB SWITCH 2", "APXS DOOR SWITCH", "APXS CONTACT SWITCH")	X	X
185	END_GROUP	= IDD_ARTICULATION_STATE	X	X

PDS Label Keyword / Comment & Example Value	Ground		Flight		RDR																		
	EDR	EDR	EDR	EDR	CCD Test Data	GSE Calibr.	Flat Field Files	Obs (all Instr.)	Sci (Pancam)	Sci (MIM)	Inverse LUT	Rad Correction	Linearized	Distort	XYZ	Range	Surf Normal	Slope	IPP Reach	Mosaic (Cyl)	Mosaic (PLP)	Mosaic (C/P)	Mosaic (R/P)

186																																
187	/* COORDINATE SYSTEM STATE: INSTRUMENT DEPLOYMENT DEVICE */																															
188																																
189	GROUP	=	IDD_COORDINATE_SYSTEM	X	X	X	X	X	X	X	X	
190	SOLUTION_ID	=	"mipl_rgd_sol3nav_5"	X	X	X	X	X	o	o	o	o	o	o	o	o	o	o	o	o	o	o	o	o	o	X	X	X	X	X	X	
191	COORDINATE_SYSTEM_NAME	=	MB_FRAME	X	X	X	X	X	X	X	X	
192	COORDINATE_SYSTEM_INDEX	=	(1, 2, 0, 0, 0)	X	X	X	X	X	X	X	X	
193	COORDINATE_SYSTEM_INDEX_NAME	=	(SITE, DRIVE, IDD, PMA, HGA)	X	X	X	X	X	X	X	X	
194	ORIGIN_OFFSET_VECTOR	=	(0.0230152, -0.076101, 0.874005)	X	X	X	X	X	X	X	X	
195	ORIGIN_ROTATION_QUATERNION	=	(0.922297, -0.0165226, -0.0413094, 0.382304)	X	X	X	X	X	X	X	X	
196	POSITIVE_AZIMUTH_DIRECTION	=	CLOCKWISE	X	X	X	X	X	X	X	X	
197	POSITIVE_ELEVATION_DIRECTION	=	UP	X	X	X	X	X	X	X	X	
198	REFERENCE_COORD_SYSTEM_NAME	=	ROVER_FRAME	X	X	X	X	X	X	X	X	
199	REFERENCE_COORD_SYSTEM_INDEX	=	(1, 2, 0, 0, 0)	X	X	X	X	X	X	X	X	
200	REFERENCE_COORD_SYSTEM_SOLN_ID	=	"mipl_rgd_sol3nav_5"	X	X	X	X	X	o	o	o	o	o	o	o	o	o	o	o	o	o	o	o	o	o	X	X	X	X	X	X	
201	END_GROUP	=	IDD_COORDINATE_SYSTEM	X	X	X	X	X	X	X	X	
202																																
203	/* ARTICULATION DEVICE STATE: PANCAM MAST ASSEMBLY */																															
204																																
205	GROUP	=	PMA_ARTICULATION_STATE	X	X	X	X	X	X	X	X	
206	SOLUTION_ID	=	"mipl_rgd_sol3nav_5"	X	X	X	X	X	o	o	o	o	o	o	o	o	o	o	o	o	o	o	o	o	o	X	X	X	X	X	X	
207	ARTICULATION_DEVICE_ID	=	"PMA"	X	X	X	X	X	X	X	X	
208	ARTICULATION_DEVICE_NAME	=	"PANCAM MAST ASSEMBLY"	X	X	X	X	X	X	X	X	
209	ARTICULATION_DEVICE_ANGLE	=	(3.46789 <rad>, 5.6702 <rad>, 8.02938 <rad>, 92.0847 <rad>, 88.0932 <rad>, 50.0374 <rad>)	X	X	X	X	X	X	X	X
210	ARTICULATION_DEVICE_ANGLE_NAME	=	("AZIMUTH-MEASURED", "ELEVATION-MEASURED", "AZIMUTH-REQUESTED", "ELEVATION-REQUESTED", "AZIMUTH-INITIAL", "ELEVATION-INITIAL")	X	X	X	X	X	X	X	X	
211	ARTICULATION_DEVICE_MODE	=	DEPLOYED	X	X	X	X	X	X	X	X	
212	END_GROUP	=	PMA_ARTICULATION_STATE	X	X	X	X	X	X	X	X	
213																																
214	/* COORDINATE SYSTEM STATE: PANCAM MAST ASSEMBLY */																															
215																																
216	GROUP	=	PMA_COORDINATE_SYSTEM	X	X	X	X	X	X	X	X	
217	SOLUTION_ID	=	"mipl_rgd_sol3nav_5"	X	X	X	X	X	o	o	o	o	o	o	o	o	o	o	o	o	o	o	o	o	o	X	X	X	X	X	X	
218	COORDINATE_SYSTEM_NAME	=	MAST_FRAME	X	X	X	X	X	X	X	X	
219	COORDINATE_SYSTEM_INDEX	=	(1, 2, 0, 0, 0)	X	X	X	X	X	X	X	X	
220	COORDINATE_SYSTEM_INDEX_NAME	=	(SITE, DRIVE, IDD, PMA, HGA)	X	X	X	X	X	X	X	X	
221	ORIGIN_OFFSET_VECTOR	=	(0.0230152, -0.076101, 0.874005)	X	X	X	X	X	X	X	X	
222	ORIGIN_ROTATION_QUATERNION	=	(0.922297, -0.0165226, -0.0413094, 0.382304)	X	X	X	X	X	X	X	X	
223	POSITIVE_AZIMUTH_DIRECTION	=	CLOCKWISE	X	X	X	X	X	X	X	X	
224	POSITIVE_ELEVATION_DIRECTION	=	UP	X	X	X	X	X	X	X	X	
225	REFERENCE_COORD_SYSTEM_NAME	=	ROVER_FRAME	X	X	X	X	X	X	X	X	
226	REFERENCE_COORD_SYSTEM_INDEX	=	(1, 2, 0, 0, 0)	X	X	X	X	X	X	X	X	
227	REFERENCE_COORD_SYSTEM_SOLN_ID	=	"mipl_rgd_sol3nav_5"	X	X	X	X	X	o	o	o	o	o	o	o	o	o	o	o	o	o	o	o	o	o	X	X	X	X	X	X	
228	END_GROUP	=	PMA_COORDINATE_SYSTEM	X	X	X	X	X	X	X	X	
229																																
230	/* ARTICULATION DEVICE STATE: MOBILITY CHASSIS */																															
231																																
232	GROUP	=	CHASSIS_ARTICULATION_STATE	X	X	X	X	X	X	X	X	
233	SOLUTION_ID	=	"mipl_rgd_sol3nav_5"	X	X	X	X	X	o	o	o	o	o	o	o	o	o	o	o	o	o	o	o	o	o	X	X	X	X	X	X	
234	ARTICULATION_DEVICE_ID	=	"CHASSIS"	X	X	X	X	X	X	X	X	
235	ARTICULATION_DEVICE_NAME	=	"MOBILITY CHASSIS"	X	X	X	X	X	X	X	X	

PDS Label Keyword / Comment & Example Value			Ground		Flight	RDR																					
			EDR	EDR	EDR	CCD Test Data	GSE Calibr.	Flat Field Files	Obs (all Instr.)	Sci (Pancam)	Sci (MVI)	Inverse LUT	Rad Correction	Linearized	Disparity	XYZ	Range	Surf Normal	Surf Rough	IPD Slope	IPD Reach	Mosaic (C/L)	Mosaic (P/L)	Mosaic (C/R)	Mosaic (R/O)	Mosaic (O/R)	
236	ARTICULATION_DEVICE_ANGLE	= (1.23456 <rad>, 3.4567 <rad>, 23.456 <rad>, 0.3467 <rad>, 0.859342 <rad>, 3.5678 <rad>, 9.38475 <rad>)	X	X	X	X	X	X	X	X
237	ARTICULATION_DEVICE_ANGLE_NAME	= ("LEFT FRONT WHEEL", "RIGHT FRONT WHEEL", "LEFT REAR WHEEL", "RIGHT REAR WHEEL", "LEFT BOGIE", "RIGHT BOGIE", "DIFFERENTIAL BOGIE")	X	X	X	X	X	X	X	X
238	ARTICULATION_DEVICE_MODE	= DEPLOYED	X	X	X	X	X	X	X	X
239	END_GROUP	= CHASSIS_ARTICULATION_STATE	X	X	X	X	X	X	X	X
240																											
241	/* OBSERVATION REQUEST */			X	X	.	p	p	p	p	p	p	p	p	p	p	p	p	p	p	p	X	X	X	X	X	X
242																											
243	GROUP	= OBSERVATION_REQUEST_PARMS	X	X	X	X	X	X	X	X
244	SOURCE_ID	= "GROUND COMMANDED"	X	X	X	X	X	X	X	X
245	COMMAND_INSTRUMENT_ID	= "PANCAM_LEFT"	X	X	X	X	X	X	X	X
246	FILTER_NAME	= PANCAM_L2_753NM	X	X	X	X	X	X	X	X
247	AUTO_EXPOSURE_DATA_CUT	= 1024	X	X	X	X	X	X	X	X
248	AUTO_EXPOSURE_PERCENT	= 20.0	X	X	X	X	X	X	X	X
249	AUTO_EXPOSURE_PIXEL_FRACTION	= 50.0	X	X	X	X	X	X	X	X
250	BAD_PIXEL_REPLACEMENT_FLAG	= TRUE	X	X	X	X	X	X	X	X
251	DETECTOR_ERASE_COUNT	= 10	X	X	X	X	X	X	X	X
252	EARLY_PIXEL_SCALE_FLAG	= TRUE	X	X	X	X	X	X	X	X
253	EARLY_IMAGE_RETURN_FLAG	= TRUE	X	X	X	X	X	X	X	X
254	EXPOSURE_TYPE	= AUTO	X	X	X	X	X	X	X
255	EXPOSURE_SCALE_FACTOR	= 4.2135	X	X	X	X	X	X	X	X
256	EXPOSURE_DURATION_COUNT	= 129	X	X	X	X	X	X	X
257	EXPOSURE_TABLE_ID	= "PANCAM_L2"	X	X	X	X	X	X	X	X
258	EXPOSURE_TBL_UPDATE_FLAG	= TRUE	X	X	X	X	X	X	X	X
259	FLAT_FIELD_CORRECTION_FLAG	= TRUE	X	X	X	X	X	X	X	X
260	INSTRUMENT_COORDINATE_ID	= "MAST AZEL"	X	X	X	X	X	X	X	X
261	INSTRUMENT_COORDINATE	= (3.4589 <rad>, 38.90734 <rad>)	X	X	X	X	X	X	X	X
262	INSTRUMENT_BORESIGHT_ID	= "CAMERA_BAR"	X	X	X	X	X	X	X	X
263	INSTRUMENT_IDLE_TIMEOUT	= 1000 <s>	X	X	X	X	X	X	X	X
264	MAX_AUTO_EXPOS_ITERATION_COUNT	= 5	X	X	X	X	X	X	X	X
265	SHUTTER_CORRECTION_MODE_ID	= "CONDITIONAL"	X	X	X	X	X	X	X	X
266	SHUTTER_CORRECT_THRESH_COUNT	= 10	X	X	X	X	X	X	X	X
267	END_GROUP	= OBSERVATION_REQUEST_PARMS	X	X	X	X	X	X	X	X
268																											
269	/* IMAGE REQUEST */			X	X	.	p	p	p	p	p	p	p	p	p	p	p	p	p	p	p	X	X	X	X	X	X
270																											
271	GROUP	= IMAGE_REQUEST_PARMS	X	X	X	X	X	X	X	X
272	SOURCE_ID	= "GROUND COMMANDED"	X	X	X	X	X	X	X	X
273	GROUP_APPLICABILITY_FLAG	= FALSE	X	X	X	X	X	X	X	X
274	DOWNLOAD_PRIORITY	= 0	X	X	X	X	X	X	X	X
275	PIXEL_DOWNSAMPLE_OPTION	= SW_MEAN	X	X	X	X	X	X	X	X
276	PIXEL_AVERAGING_HEIGHT	= 3	X	X	X	X	X	X	X	X
277	PIXEL_AVERAGING_WIDTH	= 3	X	X	X	X	X	X	X	X
278	SAMPLE_BIT_MODE_ID	= "LUT6"	X	X	X	X	X	X	X	X
279	INST_CMPRS_MODE	= 1	X	X	X	X	X	X	X	X
280	INST_CMPRS_RATE	= 19.30945	X	X	X	X	X	X	X	X
281	INST_CMPRS_QUALITY	= 3	X	X	X	X	X	X	X	X
282	INST_CMPRS_FILTER	= A	X	X	X	X	X	X	X	X
283	INST_CMPRS_SEGMENTS	= 32	X	X	X	X	X	X	X	X
284	INST_DECOMP_STAGES	= 3	X	X	X	X	X	X	X	X
285	END_GROUP	= IMAGE_REQUEST_PARMS	X	X	X	X	X	X	X	X

PDS Label Keyword / Comment & Example Value			Ground	Flight	RDR																					
			EDR	EDR	CCD Test Data	GSE Calibr.	Flat Field Files	Obs (all Instr.)	Sci (Panoram)	Sci (M/M)	Inverse LUT	Rad Correction	Linearized	Distort	XYZ	Range	Surf Normal	Slope	Rough	IPP Reach	Mosaic (C/L)	Mosaic (P/L)	Mosaic (C/R)	Mosaic (P/R)	Mosaic (L/O)	Mosaic (R/O)
286																										
287	/* REFERENCE PIXEL REQUEST */			X	X		p	p	p	p	p	p	p	p	p	p	p	p	p	p	X	X	X	X	X	X
288																										
289	GROUP	= REFERENCE_PIXEL_REQUEST_PARMS	X	X		X	X	X	X	X	X
290	SOURCE_ID	= "GROUND COMMANDED"	X	X		X	X	X	X	X	X
291	GROUP_APPLICABILITY_FLAG	= FALSE	X	X		X	X	X	X	X	X
292	DOWNLOAD_PRIORITY	= 0	X	X		X	X	X	X	X	X
293	INST_CMPRS_MODE	= 1	X	X		X	X	X	X	X	X
294	INST_CMPRS_RATE	= 19.30945	X	X		X	X	X	X	X	X
295	INST_CMPRS_QUALITY	= 3	X	X		X	X	X	X	X	X
296	INST_CMPRS_FILTER	= A	X	X		X	X	X	X	X	X
297	INST_CMPRS_SEGMENTS	= 32	X	X		X	X	X	X	X	X
298	INST_DECOMP_STAGES	= 3	X	X		X	X	X	X	X	X
299	END_GROUP	= REFERENCE_PIXEL_REQUEST_PARMS	X	X		X	X	X	X	X	X
300																										
301	/* THUMBNAIL REQUEST */			X	X		p	p	p	p	p	p	p	p	p	p	p	p	p	p	X	X	X	X	X	X
302																										
303	GROUP	= THUMBNAIL_REQUEST_PARMS	X	X		X	X	X	X	X	X
304	SOURCE_ID	= "GROUND COMMANDED"	X	X		X	X	X	X	X	X
305	GROUP_APPLICABILITY_FLAG	= FALSE	X	X		X	X	X	X	X	X
306	DOWNLOAD_PRIORITY	= 0	X	X		X	X	X	X	X	X
307	LINES	= 256	X	X		X	X	X	X	X	X
308	LINE_SAMPLES	= 256	X	X		X	X	X	X	X	X
309	SAMPLE_BIT_MODE_ID	= "LUT3"	X	X		X	X	X	X	X	X
310	INST_CMPRS_MODE	= 1	X	X		X	X	X	X	X	X
311	INST_CMPRS_RATE	= 19.30945	X	X		X	X	X	X	X	X
312	INST_CMPRS_QUALITY	= 3	X	X		X	X	X	X	X	X
313	INST_CMPRS_FILTER	= A	X	X		X	X	X	X	X	X
314	INST_CMPRS_SEGMENTS	= 32	X	X		X	X	X	X	X	X
315	INST_DECOMP_STAGES	= 3	X	X		X	X	X	X	X	X
316	END_GROUP	= THUMBNAIL_REQUEST_PARMS	X	X		X	X	X	X	X	X
317																										
318	/* SUBFRAME REQUEST */			X	X		p	p	p	p	p	p	p	p	p	p	p	p	p	p	X	X	X	X	X	X
319																										
320	GROUP	= SUBFRAME_REQUEST_PARMS	X	X		X	X	X	X	X	X
321	SOURCE_ID	= "GROUND COMMANDED"	X	X		X	X	X	X	X	X
322	GROUP_APPLICABILITY_FLAG	= TRUE	X	X		X	X	X	X	X	X
323	SUBFRAME_TYPE	= HW_SW	X	X		X	X	X	X	X	X
324	FIRST_LINE	= 1	X	X		X	X	X	X	X	X
325	FIRST_LINE_SAMPLE	= 1	X	X		X	X	X	X	X	X
326	LINES	= 100	X	X		X	X	X	X	X	X
327	LINE_SAMPLES	= 100	X	X		X	X	X	X	X	X
328	END_GROUP	= SUBFRAME_REQUEST_PARMS	X	X		X	X	X	X	X	X
329																										
330	/* ROW SUMMATION REQUEST */			X	X		p	p	p	p	p	p	p	p	p	p	p	p	p	p	X	X	X	X	X	X
331																										
332	GROUP	= ROW_SUM_REQUEST_PARMS	X	X		X	X	X	X	X	X
333	SOURCE_ID	= "GROUND COMMANDED"	X	X		X	X	X	X	X	X
334	GROUP_APPLICABILITY_FLAG	= TRUE	X	X		X	X	X	X	X	X
335	DOWNLOAD_PRIORITY	= 9	X	X		X	X	X	X	X	X
336	END_GROUP	= ROW_SUM_REQUEST_PARMS	X	X		X	X	X	X	X	X
337																										
338	/* COLUMN SUMMATION REQUEST */			X	X		p	p	p	p	p	p	p	p	p	p	p	p	p	p	X	X	X	X	X	X
339																										
340	GROUP	= COLUMN_SUM_REQUEST_PARMS	X	X		X	X	X	X	X	X
341	SOURCE_ID	= "GROUND COMMANDED"	X	X		X	X	X	X	X	X

PDS Label Keyword / Comment & Example Value			Ground		Flight		RDR																			
			EDR		EDR		CCD Test Data	GSE Calibr.	Flat Field Files	Obs (all Instr.)	Sci (PanCam)	Sci (MI)	Inverse LUT	Rad Correction	Linearized Disparity	XYZ Range	Surf Normal	Slope Rough	IPP Reach	Mosaic (C/L)	Mosaic (P/L)	Mosaic (C/R)	Mosaic (R/O)	Mosaic (O/R)		
342	GROUP_APPLICABILITY_FLAG	= TRUE	X	X
343	DOWNLOAD_PRIORITY	= 8	X	X
344	END_GROUP	= COLUMN_SUM_REQUEST_PARMS	X	X
345																										
346	/* SUN FIND REQUEST */			X	X	p	p	p	p	p	p	p	p	p	p	p	p	p	p	p	p	p	p	p	p	p
347																										
348	GROUP	= SUN_FIND_REQUEST_PARMS	X	X
349	SOURCE_ID	= "GROUND COMMANDED"	X	X
350	GROUP_APPLICABILITY_FLAG	= TRUE	X	X
351	LINES	= 51	X	X
352	LINE_SAMPLES	= 101	X	X
353	END_GROUP	= SUN_FIND_REQUEST_PARMS	X	X
354																										
355	/* HISTOGRAM REQUEST */			X	X	p	p	p	p	p	p	p	p	p	p	p	p	p	p	p	p	p	p	p	p	p
356																										
357	GROUP	= HISTOGRAM_REQUEST_PARMS	X	X
358	SOURCE_ID	= "GROUND COMMANDED"	X	X
359	GROUP_APPLICABILITY_FLAG	= TRUE	X	X
360	DOWNLOAD_PRIORITY	= 10	X	X
361	END_GROUP	= HISTOGRAM_REQUEST_PARMS	X	X
362																										
363	/* INSTRUMENT STATE RESULTS */			X	X	p	p	p	p	p	p	p	p	p	p	p	p	p	p	p	p	p	p	p	p	p
364																										
365	GROUP	= INSTRUMENT_STATE_PARMS	X	X
366	AZIMUTH_FOV	= 14.0032 <deg>	X	X
367	ELEVATION_FOV	= 13.5656 <deg>	X	X
368	BAD_PIXEL_REPLACEMENT_ID	= "3"	X	X
369	DETECTOR_FIRST_LINE	= 1	X	X
370	DETECTOR_LINES	= 430	X	X
371	DETECTOR_TO_IMAGE_ROTATION	= 90	X	X
372	Downsample_Method	= HARDWARE	X	X
373	EXPOSURE_COUNT	= 33	X	X
374	EXPOSURE_DURATION	= 216.0 <ms>	X
375	EXPOSURE_DURATION_COUNT	= 3	X
376	FILTER_NAME	= PANCAM_L2_753NM	X
377	FILTER_NUMBER	= 2	X
378	FLAT_FIELD_CORRECTION_FLAG	= TRUE	X	X
379	FLAT_FIELD_CORRECTION_PARM	= (-10.4344, -11.4673, -10.4344, -11.4673, -10.4344)	X	X
380	INSTRUMENT_MODE_ID	= "FULL_FRAME"	X
381	INSTRUMENT_TEMPERATURE	= (-10.4344 <degC>, -11.4673 <degC>, -10.4344 <degC>, -11.4673 <degC>, -10.4344 <degC>, -11.4673 <degC>, -5.0345 <degC>, -16.7433 <degC>, -22.7433 <degC>)	X
382	INSTRUMENT_TEMPERATURE_NAME	= ("FRONT HAZ ELECTRONICS", "REAR HAZ ELECTRONICS", "LEFT PAN ELECTRONICS", "LEFT PAN CCD", "RIGHT PAN CCD", "LEFT NAV CCD", "MI CCD", "MI ELECTRONICS", "EDL CCD")	X
383	OFFSET_MODE_ID	= "4095"	X	X
384	PIXEL_AVERAGING_HEIGHT	= 3	X	X
385	PIXEL_AVERAGING_WIDTH	= 3	X	X
386	SAMPLE_BIT_METHOD	= HARDWARE	X	X	m	m	m	m	m	m	m	m	m	m	m	m	m	m	m	m	m	m	m	m	m	m
387	SAMPLE_BIT_MODE_ID	= "LUT6"	X	X
388	SHUTTER_EFFECT_CORRECTION_FLAG	= TRUE	X	X
389	SUN_FIND_FLAG	= TRUE	X	X
390	SUN_FIND_PARM	= (10.0, -11.4673, -10.4344)	X	X

PDS Label Keyword / Comment & Example Value			Ground		Flight		RDR																		
			EDR	EDR	EDR	EDR	CCD Test Data	GSE Calibr.	Flat Field Files	Obs (all Instr.)	Sci (Panoram)	Sci (MM)	Inverse LUT	Rad Correction	Linearized Disparity	X/Y Z	Range	Surf Normal	Slope	IPP Reach	Mosaic (Cyl)	Mosaic (PL)	Mosaic (C/P)	Mosaic (R/O)	Mosaic (ORT)
391	SUN_FIND_PARM_NAME	= ("WINDOW SIZE", "BRIGHTNESS THRESHOLD", SUMMED BRIGHTNESS")	X	X	X	X	X	X	X
392	SUN_LINE	= 100	X	X	X	X	X	X	X
393	SUN_LINE_SAMPLE	= 100	X	X	X	X	X	X	X
394	SUN_VIEW_POSITION	= (9.335, 22.127,14.357)	X	X	X	X	X	X	X
395	SUN_VIEW_DIRECTION	= (0.885, 0.585,0.277)	X	X	X	X	X	X	X
396	END_GROUP	= INSTRUMENT_STATE_PARS	X	X	X	X	X	X	X
397																									
398	/* COMPRESSION RESULTS */		X	X	p	p	p	p	p	p	p	p	p	p	p	p	p	p	p	X	X	X	X	X	
399																									
400	GROUP	= COMPRESSION_PARS	X	X	X	X	X	X
401	ERROR_PIXELS	= 0	X	X	X	X	X	X	X
402	INST_CMPRS_DESC	= "Lossless compression algorithm developed at JPL."	X	X	X	X	X	X	X
403	INST_CMPRS_FILTER	= A	X	X	X	X	X	X	X
404	INST_CMPRS_MODE	= 1	X	X	X	X	X	X	X
405	INST_CMPRS_NAME	= "ICER ADAPTIVE VARIABLE-LENGTH CODING (ICER)"	X	X	X	X	X	X	X
406	INST_CMPRS_QUALITY	= 0	X	X	X	X	X	X	X
407	INST_CMPRS_RATE	= 7.1787	X	X	X	X	X	X	X
408	INST_CMPRS_RATIO	= 1.6716	X	X	X	X	X	X	X
409	INST_CMPRS_SEGMENTS	= 4	X	X	X	X	X	X	X
410	INST_CMPRS_SEGMENT_QUALITY	= (0,0,0,0)	X	X	X	X	X	X	X
411	INST_CMPRS_SEGMENT_STATUS	= (1,7,11,21)	X	X	X	X	X	X	X
412	INST_CMPRS_SEG_FIRST_LINE	= (10,24,13,60)	X	X	X	X	X	X	X
413	INST_CMPRS_SEG_FIRST_LINE_SAMP	= (5,5,5,5)	X	X	X	X	X	X	X
414	INST_CMPRS_SEG_LINES	= (20,20,20,20)	X	X	X	X	X	X	X
415	INST_CMPRS_SEG_SAMPLES	= (10,10,30,30)	X	X	X	X	X	X	X
416	INST_CMPRS_SEG_MISSING_PIXELS	= "N/A"	X	X	X	X	X	X	X
417	INST_DECOMP_STAGES	= 4	X	X	X	X	X	X	X
418	END_GROUP	= COMPRESSION_PARS	X	X	X	X	X	X
419																									
420	/* GROUND SUPPORT EQUIPMENT DATA ELEMENTS */		X	p	X	X	X	X	X	X	X	X	X	X	X	X	X	X	X	X	X	X	X	X	X
421																									
422	GROUP	= GROUND_SUPPORT_EQUIPMENT	X	.	X	X	X	X	X	X	X	X	X	X	X	X	X	X	X	X	X	X	X	X	X
423	CAMERA_LOCATION_ID	= "3"	X	.	X	X	X	X	X	X	X	X	X	X	X	X	X	X	X	X	X	X	X	X	X
424	FACILITY_NAME	= "169/109A"	X	.	X	X	X	X	X	X	X	X	X	X	X	X	X	X	X	X	X	X	X	X	X
425	LIGHT_SOURCE_NAME	= ROOM	X	.	X	X	X	X	X	X	X	X	X	X	X	X	X	X	X	X	X	X	X	X	X
426	LIGHT_SOURCE_DISTANCE	= 10.0 <m>	X	.	X	X	X	X	X	X	X	X	X	X	X	X	X	X	X	X	X	X	X	X	X
427	LIGHT_SOURCE_TYPE	= LIGHT	X	.	X	X	X	X	X	X	X	X	X	X	X	X	X	X	X	X	X	X	X	X	X
428	PRESSURE	= AMBIENT	X	.	X	X	X	X	X	X	X	X	X	X	X	X	X	X	X	X	X	X	X	X	X
429	PRODUCER_FULL_NAME	= "JOE SMITH"	X	.	X	X	X	X	X	X	X	X	X	X	X	X	X	X	X	X	X	X	X	X	X
430	TARGET_DISTANCE	= 10.0 <m>	X	.	X	X	X	X	X	X	X	X	X	X	X	X	X	X	X	X	X	X	X	X	X
431	TARGET_NAME	= ROOM	X	.	X	X	X	X	X	X	X	X	X	X	X	X	X	X	X	X	X	X	X	X	X
432	TEST_PHASE_NAME	= DEVELOPMENT	X	.	X	X	X	X	X	X	X	X	X	X	X	X	X	X	X	X	X	X	X	X	X
433	NOTE	= "TEST FRAME TYPES"	X	.	X	X	X	X	X	X	X	X	X	X	X	X	X	X	X	X	X	X	X	X	X
434	END_GROUP	= GROUND_SUPPORT_EQUIPMENT	X	.	X	X	X	X	X	X	X	X	X	X	X	X	X	X	X	X	X	X	X	X	X
435																									
436	/* DERIVED GEOMETRY DATA ELEMENTS: ROVER FRAME */		X	X	p	p	p	p	p	p	p	p	p	p	p	p	p	p	p	X	X	X	X	X	
437																									
438	GROUP	= ROVER_DERIVED_GEOMETRY_PARS	X	X	X	X	X	X	X
439	SOLUTION_ID	= "mipl_rgd_sol2nav_5"	X	X	X	X	X	X	X	X	X	X	X	X	X	X	X	X	X	X	X	X	X	X	X
440	INSTRUMENT_AZIMUTH	= 92.0847 <deg>	X	X	X	X	X	X	X
441	INSTRUMENT_ELEVATION	= 0.894 <deg>	X	X	X	X	X	X	X
442	REFERENCE_COORD_SYSTEM_NAME	= ROVER_FRAME	X	X	X	X	X	X	X
443	REFERENCE_COORD_SYSTEM_INDEX	= (1, 2, 0, 0, 0)	X	X	X	X	X	X	X
444	REFERENCE_COORD_SYSTEM_SOLN_ID	= "mipl_rgd_sol2nav_5"	X	X	X	X	X	X	X	X	X	X	X	X	X	X	X	X	X	X	X	X	X	X	X

PDS Label Keyword / Comment & Example Value			Ground		Flight		RDR																						
			EDR	EDR	EDR	EDR	CCD Test Data	GSE Calibr.	Flat Field Files	Obs (all Instr.)	Sci (Pancam)	Sci (MIM)	Inverse LUT	Rad Correction	Linearization	Distortion	XYZ	Range	Surf Normal	Slope	IPP Rough	IPP Reach	Mosaic (Cyl)	Mosaic (PL)	Mosaic (Cyl)	Mosaic (PL)	Mosaic (Cyl)	Mosaic (PL)	
445	END_GROUP	= ROVER_DERIVED_GEOMETRY_PARM MS	X	X	X	X	X	X	X	X	X
446																													
447	/* DERIVED GEOMETRY DATA ELEMENTS: SITE FRAME */			X	X	p	p	p	p	p	p	p	p	p	p	p	p	p	p	p	p	p	X	X	X	X	X	X	
448																													
449	GROUP	= SITE_DERIVED_GEOMETRY_PARMS	X	X	X	X	X	X	X	X	X	
450	SOLUTION_ID	= "mipl_rgd_sol3nav_5"	X	X	X	X	X	X	X	X	X	X	X	X	X	X	X	X	X	X	X	X	X	X	X	X	X	X	
451	INSTRUMENT_AZIMUTH	= 131.808 <deg>	X	X	X	X	X	X	X	X	X	
452	INSTRUMENT_ELEVATION	= -18.2877 <deg>	X	X	X	X	X	X	X	X	X	
453	REFERENCE_COORD_SYSTEM_NAME	= SITE_FRAME	X	X	X	X	X	X	X	X	X	
454	REFERENCE_COORD_SYSTEM_INDEX	= 1	X	X	X	X	X	X	X	X	X	
455	REFERENCE_COORD_SYSTEM_SOLN_ID	= "mipl_rgd_sol2nav_5"	X	X	X	X	X	X	X	X	X	X	X	X	X	X	X	X	X	X	X	X	X	X	X	X	X	X	
456	SOLAR_AZIMUTH	= 6.5029 <deg>	X	X	X	X	X	X	X	X	X	
457	SOLAR_ELEVATION	= 38.4419 <deg>	X	X	X	X	X	X	X	X	X	
458	END_GROUP	= SITE_DERIVED_GEOMETRY_PARM	X	X	X	X	X	X	X	X	X	
459																													
460	/* DERIVED IMAGE DATA ELEMENTS */			X	X	p	p	p	p	p	p	p	p	p	p	p	p	p	p	p	p	p	p	p	p	p	p	p	
461																													
462	GROUP	= DERIVED_IMAGE_PARMS	X	X	X	X	X	
463	DERIVED_IMAGE_TYPE	= XYZ_MAP	X	X	X	X	X	
464	RADIANCE_SCALING_FACTOR	= 5 <W/m^2/nm/sr>	X	X	X	X	X	
465	RADIANCE_OFFSET	= 1000 <W/m^2/nm/sr>	X	X	X	X	X	
466	RADIOMETRIC_CORRECTION_TYPE	= PANCAL	X	X	X	X	X	
467	RANGE_ORIGIN_VECTOR	= (0.0230152, -0.076101, 0.874005)	X	X	X	X	X	
468	REFERENCE_COORD_SYSTEM_NAME	= SITE_FRAME	X	X	X	X	X	
469	REFERENCE_COORD_SYSTEM_INDEX	= 1	X	X	X	X	X	
470	REFERENCE_COORD_SYSTEM_SOLN_ID	= "mipl_rgd_sol2nav_5"	X	X	X	X	X	X	X	X	X	X	X	X	X	X	X	X	X	X	X	X	X	X	X	X	X	X	
471	CONFIGURATION_BAND_ID	= ("ELBOW_UP_WRIST_UP", "ELBOW_UP_WRIST_DOWN", "ELBOW_DOWN_WRIST_UP", "ELBOW_DOWN_WRIST_DOWN")	X	X	X	X	X	X	X	X	X	X	X	
472	INSTRUMENT_BAND_ID	= (MI,RAT,MB,APXS)	X	X	X	X	X	X	X	X	X	X	X	
473	INPUT_IMAGE	= "1P130320398ESF0400P2838L5M1"	X	X	X	X	X	s	s	s	X	X	X	X	X	X	X	X	X	X	X	X	X	X	X	X	X	X	
474	PROCESSING_INFO	= ""	X	X	X	X	X	o	o	o	X	X	X	X	X	X	X	X	X	X	X	X	X	X	X	X	X	X	
475	SOFTWARE_LANGUAGE	= "IDL"	X	X	X	X	X	s	s	s	X	X	X	X	X	X	X	X	X	X	X	X	X	X	X	X	X	X	
476	SOFTWARE_MODULE_NAME	= "MER_PANCAL_IMAGE"	X	X	X	X	X	s	s	s	X	X	X	X	X	X	X	X	X	X	X	X	X	X	X	X	X	X	
477	SOFTWARE_MODULE_TYPE	= "FUNCTION"	X	X	X	X	X	s	s	s	X	X	X	X	X	X	X	X	X	X	X	X	X	X	X	X	X	X	
478	NUM_SOFTWARE_PARAMETERS	= 1	X	X	X	X	X	s	s	s	X	X	X	X	X	X	X	X	X	X	X	X	X	X	X	X	X	X	
479	SOFTWARE_PARAMETER_NAME_1	= "FILENAME"	X	X	X	X	X	o	o	o	X	X	X	X	X	X	X	X	X	X	X	X	X	X	X	X	X	X	
480	SOFTWARE_PARAMETER_VALUE_1	= "1P139207903EDN2821P2618L2M1.IM G.gz"	X	X	X	X	X	o	o	o	X	X	X	X	X	X	X	X	X	X	X	X	X	X	X	X	X	X	
481	SOFTWARE_PARAMETER_TYPE_1	= "STRING"	X	X	X	X	X	o	o	o	X	X	X	X	X	X	X	X	X	X	X	X	X	X	X	X	X	X	
482	NUM_SOFTWARE_KEYWORDS	= 1	X	X	X	X	X	s	s	s	X	X	X	X	X	X	X	X	X	X	X	X	X	X	X	X	X	X	
483	SOFTWARE_KEYWORD_NAME_1	= "AMBIENT"	X	X	X	X	X	o	o	o	X	X	X	X	X	X	X	X	X	X	X	X	X	X	X	X	X	X	
484	SOFTWARE_KEYWORD_VALUE_1	= 0	X	X	X	X	X	o	o	o	X	X	X	X	X	X	X	X	X	X	X	X	X	X	X	X	X	X	
485	SOFTWARE_KEYWORD_TYPE_1	= "INT"	X	X	X	X	X	o	o	o	X	X	X	X	X	X	X	X	X	X	X	X	X	X	X	X	X	X	
486	RESPONSIVITY_CONSTANTS	= (4.750000000000000E-06, 3.607000000000000E-09, 0.000000000000000)	X	X	X	X	X	s	s	s	X	X	X	X	X	X	X	X	X	X	X	X	X	X	X	X	X	X	
487	RESPONSIVITY_CONSTANTS_FILE	= "default_responsivity_constants.txt"	X	X	X	X	X	s	s	s	X	X	X	X	X	X	X	X	X	X	X	X	X	X	X	X	X	X	
488	BIAS_COEFFS_FILE	= "mer_ccd_115_bias_coeffs_01.dat"	X	X	X	X	X	o	o	o	X	X	X	X	X	X	X	X	X	X	X	X	X	X	X	X	X	X	
489	BIAS_COEFFS_FILE_DESCRIPTION	= "Bias coefficients file."	X	X	X	X	X	o	o	o	X	X	X	X	X	X	X	X	X	X	X	X	X	X	X	X	X	X	
490	FLAT_FIELD_FILE	= ("MER_FLAT_SN_115_L5_V01.IMG", "MER_FLAT_STDDEV_SN_115_L5_V0 1.IMG")	X	X	X	X	X	o	o	o	X	X	X	X	X	X	X	X	X	X	X	X	X	X	X	X	X	X	
491	FLAT_FIELD_FILE_DESCRIPTION	= ("Flat field image.", "Flat field standard deviation image.")	X	X	X	X	X	o	o	o	X	X	X	X	X	X	X	X	X	X	X	X	X	X	X	X	X	X	
492	DARK_CURRENT_FILE	= "mer_ccd_115_dark_active_coeffs_01.i mg"	X	X	X	X	X	s	s	s	X	X	X	X	X	X	X	X	X	X	X	X	X	X	X	X	X	X	
493	DARK_CURRENT_FILE_DESCRIPTION	= "Active dark coefficients image."	X	X	X	X	X	s	s	s	X	X	X	X	X	X	X	X	X	X	X	X	X	X	X	X	X	X	

PDS Label Keyword / Comment & Example Value			Ground		Flight		RDR																			
			EDR	EDR	EDR	EDR	CCD Test Data	GSE Calibr.	Flat Field Files	Obs (all Instr.)	Sci (PanCam)	Sci (MM)	Inverse Lut	Rad Correction	Linearization	Distortion	XYZ	Range	Surf Normal	Slope Rough	IPP Reach	Mosaic (Cyl)	Mosaic (PL)	Mosaic (CP)	Mosaic (RDR)	Mosaic (ORT)
494	ZERO_EXPOSURE_IMAGE	= "1P130320398ESF0400P2838L5M1"	X	X	X	X	X	X	X	X	X	X	X	X	X	X	X	X	X	X	X	X	X	X	X	X
495	REFERENCE_PIXEL_IMAGE	= "1P130320398ESF0400P2838L5M1"	X	X	X	X	X	X	X	X	X	X	X	X	X	X	X	X	X	X	X	X	X	X	X	X
496	INVERSE_LUT_FILE	= "mer_inverse_lut_2.txt"	X	X	X	X	X	X	X	X	X	X	X	X	X	X	X	X	X	X	X	X	X	X	X	
497	^MOSAIC_DESC	= "MER1_MOSAIC_DESC.TXT"	X	X	X	X	X	X	X	X	X	X	X	X	X	X	X	X	X	X	X	X	X	X	X	
498	END_GROUP	= DERIVED_IMAGE_PARMS	X	X	X	X	X	X	X	X	X	X	X	X	X	X	X	X	X	X	X	X	X	X	X	
499																										
500	/* SURFACE PROJECTION DATA ELEMENTS */		X	X	X	X	X	X	X	X	X	X	X	X	X	X	X	X	X	X	X	X	X	X	X	
501																										
502	GROUP	= SURFACE_PROJECTION_PARMS	X	X	X	X	X	X	X	X	X	X	X	X	X	X	X	X	X	X	X	X	X	X	X	
503	LINE_CAMERA_MODEL_OFFSET	= -11.7843 <pixel>	X	X	X	X	X	X	X	X	X	X	X	X	X	X	X	X	X	X	X	X	X	X	X	
504	SAMPLE_CAMERA_MODEL_OFFSET	= -17.1418 <pixel>	X	X	X	X	X	X	X	X	X	X	X	X	X	X	X	X	X	X	X	X	X	X	X	
505	LINE_PROJECTION_OFFSET	= 749.0 <pixel>	X	X	X	X	X	X	X	X	X	X	X	X	X	X	X	X	X	X	X	X	X	X	X	
506	SAMPLE_PROJECTION_OFFSET	= 749.0 <pixel>	X	X	X	X	X	X	X	X	X	X	X	X	X	X	X	X	X	X	X	X	X	X	X	
507	MAP_PROJECTION_TYPE	= CYLINDRICAL	X	X	X	X	X	X	X	X	X	X	X	X	X	X	X	X	X	X	X	X	X	X	X	
508	MAP_RESOLUTION	= (17.7607 <pix/deg>, 17.7619 <pix/deg>)	X	X	X	X	X	X	X	X	X	X	X	X	X	X	X	X	X	X	X	X	X	X	X	
509	MAP_SCALE	= (0.01 <m/pixel>, 0.01 <m/pixel>)	X	X	X	X	X	X	X	X	X	X	X	X	X	X	X	X	X	X	X	X	X	X	X	
510	MAXIMUM_ELEVATION	= -33.5129 <deg>	X	X	X	X	X	X	X	X	X	X	X	X	X	X	X	X	X	X	X	X	X	X	X	
511	MINIMUM_ELEVATION	= -74.5294 <deg>	X	X	X	X	X	X	X	X	X	X	X	X	X	X	X	X	X	X	X	X	X	X	X	
512	PROJECTION_AZIMUTH	= -10.6724 <deg>	X	X	X	X	X	X	X	X	X	X	X	X	X	X	X	X	X	X	X	X	X	X	X	
513	PROJECTION_ELEVATION	= -22.0756 <deg>	X	X	X	X	X	X	X	X	X	X	X	X	X	X	X	X	X	X	X	X	X	X	X	
514	PROJECTION_ELEVATION_LINE	= 1395.52 <pixel>	X	X	X	X	X	X	X	X	X	X	X	X	X	X	X	X	X	X	X	X	X	X	X	
515	PROJECTION_ORIGIN_VECTOR	= (-0.334 <m>, 0.202 <m>, -1.816 <m>)	X	X	X	X	X	X	X	X	X	X	X	X	X	X	X	X	X	X	X	X	X	X	X	
516	PROJECTION_X_AXIS_VECTOR	= 0.0 <m>	X	X	X	X	X	X	X	X	X	X	X	X	X	X	X	X	X	X	X	X	X	X	X	
517	PROJECTION_Y_AXIS_VECTOR	= 0.0 <m>	X	X	X	X	X	X	X	X	X	X	X	X	X	X	X	X	X	X	X	X	X	X	X	
518	PROJECTION_Z_AXIS_VECTOR	= 0.0 <m>	X	X	X	X	X	X	X	X	X	X	X	X	X	X	X	X	X	X	X	X	X	X	X	
519	PROJECTION_AXIS_OFFSET	= 0.0 <m>	X	X	X	X	X	X	X	X	X	X	X	X	X	X	X	X	X	X	X	X	X	X	X	
520	REFERENCE_AZIMUTH	= 0.0 <deg>	X	X	X	X	X	X	X	X	X	X	X	X	X	X	X	X	X	X	X	X	X	X	X	
521	REFERENCE_COORD_SYSTEM_NAME	= LOCAL_LEVEL_FRAME	X	X	X	X	X	X	X	X	X	X	X	X	X	X	X	X	X	X	X	X	X	X	X	
522	REFERENCE_COORD_SYSTEM_INDEX	= 1	X	X	X	X	X	X	X	X	X	X	X	X	X	X	X	X	X	X	X	X	X	X	X	
523	REFERENCE_COORD_SYSTEM_SOLN_ID	= "mipl_rgd_sol2nav_5"	X	X	X	X	X	X	X	X	X	X	X	X	X	X	X	X	X	X	X	X	X	X	X	
524	START_AZIMUTH	= 360 <deg>	X	X	X	X	X	X	X	X	X	X	X	X	X	X	X	X	X	X	X	X	X	X	X	
525	STOP_AZIMUTH	= 360 <deg>	X	X	X	X	X	X	X	X	X	X	X	X	X	X	X	X	X	X	X	X	X	X	X	
526	X_AXIS_MAXIMUM	= 5.0 <m>	X	X	X	X	X	X	X	X	X	X	X	X	X	X	X	X	X	X	X	X	X	X	X	
527	X_AXIS_MINIMUM	= -5.0 <m>	X	X	X	X	X	X	X	X	X	X	X	X	X	X	X	X	X	X	X	X	X	X	X	
528	Y_AXIS_MAXIMUM	= -5.0 <m>	X	X	X	X	X	X	X	X	X	X	X	X	X	X	X	X	X	X	X	X	X	X	X	
529	Y_AXIS_MINIMUM	= -5.0 <m>	X	X	X	X	X	X	X	X	X	X	X	X	X	X	X	X	X	X	X	X	X	X	X	
530	ZERO_ELEVATION_LINE	= -443.019 <pixel>	X	X	X	X	X	X	X	X	X	X	X	X	X	X	X	X	X	X	X	X	X	X	X	
531	END_GROUP	= SURFACE_PROJECTION_PARMS	X	X	X	X	X	X	X	X	X	X	X	X	X	X	X	X	X	X	X	X	X	X	X	
532																										
533	/* SURFACE MODEL DATA ELEMENTS */		X	X	X	X	X	X	X	X	X	X	X	X	X	X	X	X	X	X	X	X	X	X	X	
534																										
535	GROUP	= SURFACE_MODEL_PARMS	X	X	X	X	X	X	X	X	X	X	X	X	X	X	X	X	X	X	X	X	X	X	X	
536	SURFACE_MODEL_FILE	= 1N863294624XYL411100171L0M1	X	X	X	X	X	X	X	X	X	X	X	X	X	X	X	X	X	X	X	X	X	X	X	
537	SURFACE_MODEL_TYPE	= PLANE	X	X	X	X	X	X	X	X	X	X	X	X	X	X	X	X	X	X	X	X	X	X	X	
538	SURFACE_NORMAL_VECTOR	= (0.0, 0.0, -1.0)	X	X	X	X	X	X	X	X	X	X	X	X	X	X	X	X	X	X	X	X	X	X	X	
539	SURFACE_GROUND_LOCATION	= (0.0, 0.0, 0.0)	X	X	X	X	X	X	X	X	X	X	X	X	X	X	X	X	X	X	X	X	X	X	X	
540	REFERENCE_COORD_SYSTEM_NAME	= LOCAL_LEVEL_FRAME	X	X	X	X	X	X	X	X	X	X	X	X	X	X	X	X	X	X	X	X	X	X	X	
541	REFERENCE_COORD_SYSTEM_INDEX	= (1, 2, 0)	X	X	X	X	X	X	X	X	X	X	X	X	X	X	X	X	X	X	X	X	X	X	X	
542	REFERENCE_COORD_SYSTEM_SOLN_ID	= "mipl_rgd_sol2nav_5"	X	X	X	X	X	X	X	X	X	X	X	X	X	X	X	X	X	X	X	X	X	X	X	
543	END_GROUP	= SURFACE_MODEL_PARMS	X	X	X	X	X	X	X	X	X	X	X	X	X	X	X	X	X	X	X	X	X	X	X	
544																										
545	/* IMAGE_HEADER DATA ELEMENTS */		X	X	X	X	X	X	X	X	X	X	X	X	X	X	X	X	X	X	X	X	X	X	X	
546																										
547	OBJECT	= IMAGE_HEADER	X	X	X	X	X	X	X	X	X	X	X	X	X	X	X	X	X	X	X	X	X	X	X	
548	HEADER_TYPE	= VICAR2	X	X	X	X	X	X	X	X	X	X	X	X	X	X	X	X	X	X	X	X	X	X	X	
549	INTERCHANGE_FORMAT	= ASCII	X	X	X	X	X	X	X	X	X	X	X	X	X	X	X	X	X	X	X	X	X	X	X	
550	BYTES	= 12288	X	X	X	X	X	X	X	X	X	X	X	X	X	X	X	X	X	X	X	X	X	X	X	

PDS Label Keyword / Comment & Example Value			Ground		Flight		RDR																				
			EDR	EDR	EDR	EDR	CCD Test Data	GSE Calibr.	Flat Field Files	Obs (all Instr.)	Sci (Panoram)	Sci (MM)	Inverse LUT	Rad Correction	Linearized	Distort	Range	Surf Normal	Surf Rough	Slope	IPP Reach	Mosaic (CY)	Mosaic (PL)	Mosaic (CP)	Mosaic (RDR)	Mosaic (WR)	Mosaic (ORT)
551	^DESCRIPTION	= "VICAR2.TXT"	X	X	p	p	p	p	p	p	p	p	p	p	p	p	p	p	p	p	p	p	p	p	p	p	p
552	END_OBJECT	= IMAGE_HEADER	X	X	p	p	p	p	p	p	p	p	p	p	p	p	p	p	p	p	p	p	p	p	p	p	p
553																											
554	/* IMAGE DATA ELEMENTS */		p	p	p	p	p	p	p	p	p	p	p	p	p	p	p	p	p	p	p	p	p	p	p	p	p
555																											
556	OBJECT	= IMAGE	p	p	p	p	p	p	p	p	p	p	p	p	p	p	p	p	p	p	p	p	p	p	p	p	p
557	INTERCHANGE_FORMAT	= BINARY	p	p	p	p	p	p	p	p	p	p	p	p	p	p	p	p	p	p	p	p	p	p	p	p	p
558	LINES	= 1024	p	p	p	p	p	p	p	p	p	p	p	p	p	p	p	p	p	p	p	p	p	p	p	p	p
559	LINE_SAMPLES	= 1024	p	p	p	p	p	p	p	p	p	p	p	p	p	p	p	p	p	p	p	p	p	p	p	p	p
560	SAMPLE_TYPE	= MSB_INTEGER	p	p	p	p	p	p	p	p	p	p	p	p	p	p	p	p	p	p	p	p	p	p	p	p	p
561	SAMPLE_BITS	= 16	p	p	p	p	p	p	p	p	p	p	p	p	p	p	p	p	p	p	p	p	p	p	p	p	p
562	SAMPLE_BIT_MASK	= 2#0000111111111111#	m
563	BANDS	= 1	p	p	p	p	p	p	p	p	p	p	p	p	p	p	p	p	p	p	p	p	p	p	p	p	p
564	BAND_STORAGE_TYPE	= BAND_SEQUENTIAL	p	p	p	p	p	p	p	p	p	p	p	p	p	p	p	p	p	p	p	p	p	p	p	p	p
565	CHECKSUM	= 1.60106e+08	X	p	p	p	p	p	p	p	p	p	p	p	p	p	p	p	p	p	p	p	p	p	p	p	p
566	FIRST_LINE	= 3	X
567	FIRST_LINE_SAMPLE	= 1	X
568	LINE_PREFIX_BYTES	= 32	X	p	X	X	X	X	X	X	X	X	X	X	X	X	X	X	X	X	X	X	X	X	X	X	X
569	LINE_PREFIX_MEAN	= 50.25	X	p	X	X	X	X	X	X	X	X	X	X	X	X	X	X	X	X	X	X	X	X	X	X	X
570	LINE_SUFFIX_BYTES	= 32	X	p	X	X	X	X	X	X	X	X	X	X	X	X	X	X	X	X	X	X	X	X	X	X	X
571	LINE_SUFFIX_MEAN	= 100.25	X	p	X	X	X	X	X	X	X	X	X	X	X	X	X	X	X	X	X	X	X	X	X	X	X
572	MEAN	= 755.973	X	p	p	p	p	p	p	p	p	p	p	p	p	p	p	p	p	p	p	p	p	p	p	p	p
573	MEDIAN	= 99.0	X	p	p	p	p	p	p	p	p	p	p	p	p	p	p	p	p	p	p	p	p	p	p	p	p
574	MAXIMUM	= 3265.0	X	p	p	p	p	p	p	p	p	p	p	p	p	p	p	p	p	p	p	p	p	p	p	p	p
575	MINIMUM	= 13.0	X	p	p	p	p	p	p	p	p	p	p	p	p	p	p	p	p	p	p	p	p	p	p	p	p
576	STANDARD_DEVIATION	= 1012.48	X	p	p	p	p	p	p	p	p	p	p	p	p	p	p	p	p	p	p	p	p	p	p	p	p
577	INVALID_CONSTANT	= 0.0	X	X
578	MISSING_CONSTANT	= 0.0	X	X
579	END_OBJECT	= IMAGE	p	p	p	p	p	p	p	p	p	p	p	p	p	p	p	p	p	p	p	p	p	p	p	p	
580	END		p	p	p	p	p	p	p	p	p	p	p	p	p	p	p	p	p	p	p	p	p	p	p	p	p

APPENDIX B – Camera EDR & RDR Label Keyword Definitions

Keyword Name	Definition	Type	Units	Valid Values	<ul style="list-style-type: none"> Location in PDS Label Source 																														
APPLICATION_PROCESS_ID	Specifies the process, or source, which created the data.	integer		(see APPLICATION_PROCESS_NAME)	LOCATION <ul style="list-style-type: none"> TELEMETRY (Class) SOURCE <ul style="list-style-type: none"> CCSDS:Primary:APID 																														
APPLICATION_PROCESS_NAME	Specifies the name associated with the source or process which created the data. Note: For Mars Pathfinder, the queues were distinguished on the basis of type and priority of data.	string (256)		<table border="0"> <thead> <tr> <th>APID</th> <th>NAME</th> </tr> </thead> <tbody> <tr><td>21</td><td>"PANCAM LEFT"</td></tr> <tr><td>22</td><td>"PANCAM RIGHT"</td></tr> <tr><td>23</td><td>"NAVCAM LEFT"</td></tr> <tr><td>24</td><td>"NAVCAM RIGHT"</td></tr> <tr><td>25</td><td>"HAZCAM LEFT FRONT"</td></tr> <tr><td>26</td><td>"HAZCAM RIGHT FRONT"</td></tr> <tr><td>27</td><td>"HAZCAM LEFT REAR"</td></tr> <tr><td>28</td><td>"HAZCAM RIGHT REAR"</td></tr> <tr><td>29</td><td>"MI"</td></tr> <tr><td>30</td><td>"DESCENT IMAGER"</td></tr> <tr><td>31</td><td>"MINUTES"</td></tr> <tr><td>32</td><td>"APXS"</td></tr> <tr><td>33</td><td>"MB"</td></tr> <tr><td>34</td><td>"RAT"</td></tr> </tbody> </table>	APID	NAME	21	"PANCAM LEFT"	22	"PANCAM RIGHT"	23	"NAVCAM LEFT"	24	"NAVCAM RIGHT"	25	"HAZCAM LEFT FRONT"	26	"HAZCAM RIGHT FRONT"	27	"HAZCAM LEFT REAR"	28	"HAZCAM RIGHT REAR"	29	"MI"	30	"DESCENT IMAGER"	31	"MINUTES"	32	"APXS"	33	"MB"	34	"RAT"	LOCATION <ul style="list-style-type: none"> TELEMETRY (Class) SOURCE <ul style="list-style-type: none"> Table Lookup: <ul style="list-style-type: none"> CCSDS:Primary:APID
APID	NAME																																		
21	"PANCAM LEFT"																																		
22	"PANCAM RIGHT"																																		
23	"NAVCAM LEFT"																																		
24	"NAVCAM RIGHT"																																		
25	"HAZCAM LEFT FRONT"																																		
26	"HAZCAM RIGHT FRONT"																																		
27	"HAZCAM LEFT REAR"																																		
28	"HAZCAM RIGHT REAR"																																		
29	"MI"																																		
30	"DESCENT IMAGER"																																		
31	"MINUTES"																																		
32	"APXS"																																		
33	"MB"																																		
34	"RAT"																																		
APPLICATION_PROCESS_SUBTYPE_ID	Specifies the source/subprocess which created the data.	integer		"0" = Uncompressed Image "1" = ICER Compressed Image "2" = Uncompressed Thumbnail "3" = ICER Compressed Thumbnail "4" = Uncompressed Ref Pixels "5" = ICER Compressed Ref Pixels "6" = Histogram "7" = Row Sums "8" = Column Sums "9" = LOCO Compressed Image "11" = LOCO Compressed Thumbnail "12" = LOCO Compressed Ref Pixels	LOCATION <ul style="list-style-type: none"> TELEMETRY (Class) SOURCE <ul style="list-style-type: none"> CCSDS:UPTH:APID SubType 																														

Keyword Name	Definition	Type	Units	Valid Values	<ul style="list-style-type: none"> • Location in PDS Label • Source
ARTICULATION_DEVICE_ANGLE	<p>Specifies the value of an angle between two parts or segments of an articulated device.</p> <p>Note: MER uses radians. The PDS default unit for this keyword is degrees, so the <rad> tag is required for MER data.</p>	float array[10]	radians (<rad> unit tag required)		<p>LOCATION</p> <ul style="list-style-type: none"> • Group Dependent: <ol style="list-style-type: none"> a) CHASSIS_ARTICULATION_STATE (Group) b) IDD_ARTICULATION_STATE (Group) c) PMA_ARTICULATION_STATE (Group) d) HGA_ARTICULATION_STATE (Group) <p>SOURCE</p> <ul style="list-style-type: none"> • Group Dependent: <ol style="list-style-type: none"> a) IDPH:ImgTImHdr:pot[7] b) IDPH:ImgTImHdr:idd.q_enc[5] IDPH:ImgTImHdr:idd.q_pot[5] c) IDPH:ImgTImHdr:pma_*_azimuth IDPH:ImgTImHdr:pma_*_elevation d) IDPH:ImgTImHdr:hga_position_azimuth IDPH:ImgTImHdr:hga_position_elevation
ARTICULATION_DEVICE_ANGLE_NAME	<p>Specifies the formal name which identifies each of the values used in ARTICULATION_DEVICE_ANGLE.</p>	string array[10]		<p><u>Mobility Chassis</u> ("LEFT FRONT WHEEL", "RIGHT FRONT WHEEL", "LEFT REAR WHEEL", "RIGHT REAR WHEEL", "LEFT BOGIE", "RIGHT BOGIE", "DIFFERENTIAL BOGIE")</p> <p><u>IDD</u> ("JOINT 1 AZIMUTH-ENCODER", "JOINT 2 ELEVATION-ENCODER", "JOINT 3 ELBOW-ENCODER", "JOINT 4 WRIST-ENCODER", "JOINT 5 TURRET-ENCODER", "JOINT 1 AZIMUTH-POTENTIOMETER", "JOINT 2 ELEVATION-POTENTIOMETER", "JOINT 3 ELBOW-POTENTIOMETER", "JOINT 4 WRIST-POTENTIOMETER", "JOINT 5 TURRET-POTENTIOMETER")</p> <p><u>PMA</u> ("AZIMUTH-MEASURED", "ELEVATION-MEASURED", "AZIMUTH-REQUESTED", "ELEVATION-REQUESTED", "AZIMUTH-</p>	<p>LOCATION</p> <ul style="list-style-type: none"> • Group Dependent: <ol style="list-style-type: none"> a) CHASSIS_ARTICULATION_STATE (Group) b) IDD_ARTICULATION_STATE (Group) c) PMA_ARTICULATION_STATE (Group) d) HGA_ARTICULATION_STATE (Group) <p>SOURCE</p> <ul style="list-style-type: none"> • Group Dependent, Static Values

Keyword Name	Definition	Type	Units	Valid Values	<ul style="list-style-type: none"> Location in PDS Label Source
				INITIAL,"ELEVATION-INITIAL") HGA ("AZIMUTH", "ELEVATION")	
ARTICULATION_DEVICE_ID	<p>Specifies the unique abbreviated identification of an articulation device. An articulation device is anything that can move independently of the spacecraft to which it is attached, (e.g., mast heads, wheel bogies, arms, etc.).</p> <p>Note: The ARTICULATION_DEVICE_ID is not a unique identifier for a given articulated device. Note also that the associated ARTICULATION_DEVICE_NAME element provides the full name of the articulated device.</p>	string		"CHASSIS", "IDD", "PMA", "HGA", "FILTER"	<p>LOCATION</p> <ul style="list-style-type: none"> Group Dependent: <ul style="list-style-type: none"> a) CHASSIS_ARTICULATION_STATE (Group) b) IDD_ARTICULATION_STATE (Group) c) PMA_ARTICULATION_STATE (Group) d) HGA_ARTICULATION_STATE (Group) e) FILTER_ARTICULATION_STATE (Group) <p>SOURCE</p> <ul style="list-style-type: none"> Group Dependent, Static Values
ARTICULATION_DEVICE_MODE	<p>Specifies the deployment state (i.e., physical configuration) of an articulation device at the time of data acquisition.</p> <p>For MER this is the mode of the last move:</p> <p>"FREE SPACE" - IDD arm was moved where there was no contact with a target expected.</p> <p>"GUARDED" - IDD arm was moved where contact with the target was expected.</p> <p>"RETRACTING" - IDD arm was moved where an instrument is removed from a target.</p> <p>"PRELOAD" - IDD arm stays in contact with the target and applies force or overtravel on an instrument.</p>	string		<p>PMA</p> <p>0 = "STOWED" 1 = "DEPLOYED"</p> <p>IDD</p> <p>0 = "FREE SPACE" 1 = "GUARDED" 2 = "RETRACTING" 3 = "PRELOAD"</p>	<p>LOCATION</p> <ul style="list-style-type: none"> Group Dependent: <ul style="list-style-type: none"> a) IDD_ARTICULATION_STATE (Group) b) PMA_ARTICULATION_STATE (Group) c) CHASSIS_ARTICULATION_STATE (Group) <p>SOURCE</p> <ul style="list-style-type: none"> Group Dependent, Table Lookup: <ul style="list-style-type: none"> a) IDPH:ImgTlmHdr:idd.idd_mode b) IDPH:ImgTlmHdr:pma_deployed
ARTICULATION_DEVICE_NAME	<p>Specifies the common name of an articulation device. An articulation device is anything that can move independently of the spacecraft to which it is attached, (e.g. mast heads, wheel bogies, arms, etc.)</p> <p>Note: The associated ARTICULATION_DEVICE_ID element</p>	string		"MOBILITY CHASSIS", "INSTRUMENT DEPLOYMENT DEVICE", "PANCAM MAST ASSEMBLY", "HIGH GAIN ANTENNA", "FILTER ACTUATORS"	<p>LOCATION</p> <ul style="list-style-type: none"> Group Dependent: <ul style="list-style-type: none"> a) CHASSIS_ARTICULATION_STATE (Group) b) IDD_ARTICULATION_STATE (Group) c) PMA_ARTICULATION_STATE (Group) d) HGA_ARTICULATION_STATE (Group) e) FILTER_ARTICULATION_STATE

Keyword Name	Definition	Type	Units	Valid Values	<ul style="list-style-type: none"> Location in PDS Label Source
	provides an abbreviated name or acronym for the articulated device.				(Group) SOURCE <ul style="list-style-type: none"> Group Dependent, Static Values
ARTICULATION_DEVICE_TEMP	Specifies the temperature, in degrees Celsius, of an articulated device or some part of an articulated device.	float array[2]	deg C (<degC> unit tag required)	"-3.4e38" to "3.4e38"	LOCATION <ul style="list-style-type: none"> IDD_ARTICULATION_STATE (Group) SOURCE <ul style="list-style-type: none"> IDPH:ImgTImHdr:idd.temp[2]
ARTICULATION_DEVICE_TEMP_NAME	Specifies the array of formal names identifying each of the values used in ARTICULATION_DEVICE_TEMP.	string array[2]		("AZIMUTH JOINT 1", "TURRET JOINT 5")	LOCATION <ul style="list-style-type: none"> IDD_ARTICULATION_STATE (Group) SOURCE <ul style="list-style-type: none"> Static Value
ARTICULATION_DEV_INSTRUMENT_ID	Specifies an abbreviated name or acronym which identifies the instrument mounted on the articulation device.	string(12)		IDD 0 = "MI" 1 = "RAT" 2 = "MB" 3 = "APXS"	LOCATION <ul style="list-style-type: none"> IDD_ARTICULATION_STATE (Group) SOURCE <ul style="list-style-type: none"> Table Lookup: - IDPH:ImgTImHdr:idd_instrument
ARTICULATION_DEV_POSITION	<p>Specifies the set of indices for articulation devices that contain moving parts with discrete positions. The associated ARTICULATION_DEV_POSITION_NAME element names each moving device, and ARTICULATION_DEV_POSITION_ID provides a textual identifier that maps to the position indices.</p> <p>For MER, this is used to contain the state of all the instrument filter actuators (Pancam filter wheels and MI dust cover). Note that this is the state of all such actuators on the rover. In order to get the actual filter used for this specific image, the FILTER_NAME/FILTER_NUMBER keywords in the INSTRUMENT_STATE_PARAMS group should be used.</p> <p>See also ARTICULATION_DEV_POSITION_ID.</p>	integer array		IDPH Keyword Value 0 "0" 1 "1" 2 "2" 3 "3" 4 "4" 5 "5" 6 "6" 7 "7" 8 "8" 9 "1" 10 "2" 11 "3" 12 "4" 13 "5" 14 "6" 15 "7" 16 "8" 17 "1" 18 "2"	LOCATION <ul style="list-style-type: none"> FILTER_ARTICULATION_STATE (Group) SOURCE <ul style="list-style-type: none"> Table Lookup: - IDPH:ImgTImHdr:pma_filter_l - IDPH:ImgTImHdr:pma_filter_r - IDPH:ImgTImHdr:mi_filter
ARTICULATION_DEV_POSITION_ID	Specifies the set of identifiers corresponding to ARTICULATION_DEV_POSITION. These	string		IDPH Keyword Value 0 "NONE" 1 "PANCAM_L1_EMPTY"	LOCATION <ul style="list-style-type: none"> FILTER_ARTICULATION_STATE (Group)

Keyword Name	Definition	Type	Units	Valid Values	<ul style="list-style-type: none"> Location in PDS Label Source
	describe the position (e.g. filter), not the device (e.g., filter wheel). See also ARTICULATION_DEV_POSITION.			2 "PANCAM_L2_753NM" 3 "PANCAM_L3_673NM" 4 "PANCAM_L4_602NM" 5 "PANCAM_L5_535NM" 6 "PANCAM_L6_483NM" 7 "PANCAM_L7_440NM" 8 "PANCAM_L8_440NM_SOL_ND5" 9 "PANCAM_R1_440NM" 10 "PANCAM_R2_754NM" 11 "PANCAM_R3_803NM" 12 "PANCAM_R4_864NM" 13 "PANCAM_R5_903NM" 14 "PANCAM_R6_933NM" 15 "PANCAM_R7_1001NM" 16 "PANCAM_R8_880NM_SOL_ND5" 17 "MI_CLOSED" (cover) 18 "MI_OPEN" (cover)	SOURCE <ul style="list-style-type: none"> Table Lookup: <ul style="list-style-type: none"> IDPH:ImgTImHdr:pma_filter_l IDPH:ImgTImHdr:pma_filter_r IDPH:ImgTImHdr:mi_filter
ARTICULATION_DEV_POSITION_NAME	Specifies an array of values that provides the formal names for each entry in ARTICULATION_DEV_POSITION. This element names the actual device doing the moving, (e.g., a filter wheel), not the name of a position (e.g., the filter itself).	string array		("LEFT PANCAM FILTER", "RIGHT PANCAM FILTER", "MI DUST COVER")	LOCATION <ul style="list-style-type: none"> FILTER_ARTICULATION_STATE (Group) SOURCE <ul style="list-style-type: none"> Static Values
ARTICULATION_DEV_VECTOR	Specifies the direction and magnitude of an external force acting on the articulation device, in the rover's coordinate system, at the time the pose was computed.	float array[3]			LOCATION <ul style="list-style-type: none"> IDD_ARTICULATION_STATE (Group) SOURCE <ul style="list-style-type: none"> IDPH:ImgTImHdr:idd.tilt[3]
ARTICULATION_DEV_VECTOR_NAME	Specifies the formal name of the vector type acting on the articulation device.	string		"GRAVITY"	LOCATION <ul style="list-style-type: none"> IDD_ARTICULATION_STATE (Group) SOURCE <ul style="list-style-type: none"> Static Value
AUTO_EXPOSURE_DATA_CUT	Specifies the DN value which a specified fraction of pixels is permitted to exceed. The fraction is specified using the keyword AUTO_EXPOSURE_DATA_FRACTION.	integer		"0" to n	LOCATION <ul style="list-style-type: none"> OBSERVATION_REQUEST_PARMS (Group) SOURCE <ul style="list-style-type: none"> IDPH:ImgParams:exp_auto_dn
AUTO_EXPOSURE_PERCENT	Specifies the auto-exposure early-termination percent. If the calculated exposure time has written this value, then terminate auto exposure early.	float		"0.0" to "100.0"	LOCATION <ul style="list-style-type: none"> OBSERVATION_REQUEST_PARMS (Group) SOURCE

Keyword Name	Definition	Type	Units	Valid Values	<ul style="list-style-type: none"> Location in PDS Label Source
	Refer to document "FFD Volume 30, Imaging" [Ref 3] for a description of the valid values range.				<ul style="list-style-type: none"> IDPH:ImgParams:exp_auto_percent
AUTO_EXPOSURE_PIXEL_FRACTION	Specifies the percentage of pixels whose targeted value is higher than the AUTO_EXPOSURE_DATA_CUT keyword. Refer to document "FFD Volume 30, Imaging" [Ref 3] for a description of the valid values range.	float		"0.0" to "100.0"	<p>LOCATION</p> <ul style="list-style-type: none"> OBSERVATION_REQUEST_PARMS (Group) <p>SOURCE</p> <ul style="list-style-type: none"> IDPH:ImgParams:exp_auto_frac
AZIMUTH_FOV	Specifies the angular measure of the horizontal field of view of an imaged scene.	float	deg (<deg> unit tag required)	"0.0" to "360.0"	<p>LOCATION</p> <ul style="list-style-type: none"> INSTRUMENT_STATE_PARMS (Group) <p>SOURCE</p> <ul style="list-style-type: none"> Calculation: <ul style="list-style-type: none"> IDPH:ImgTImHdr:res_cols IDPH:ImgTImHdr:cols
BAD_PIXEL_REPLACEMENT_FLAG	Specifies whether or not bad pixel replacement processing was requested or completed. If set to TRUE, certain pixels in the image were replaced based on a bad pixel table. See BAD_PIXEL_REPLACEMENT_ID.	string(5)		0 = "FALSE" 1 = "TRUE"	<p>LOCATION</p> <ul style="list-style-type: none"> OBSERVATION_REQUEST_PARMS (Group) <p>SOURCE</p> <ul style="list-style-type: none"> IDPH:ImgParams:bad
BAD_PIXEL_REPLACEMENT_ID	Specifies the ID of the bad pixel table used in the bad pixel replacement process. The bad pixel table ID is incremented every time an update to the bad pixel table is made. See BAD_PIXEL_REPLACEMENT_FLAG.	string		0 = "N/A" "1" to "65535"	<p>LOCATION</p> <ul style="list-style-type: none"> INSTRUMENT_STATE_PARMS (Group) <p>SOURCE</p> <ul style="list-style-type: none"> IDPH:ImgTImHdr:bad
BANDS	Specifies the number of spectral bands in image or other object.	integer		"1" = EDR "3" = XYZ RDR or 3-banded multispectral Mosaic RDR	<p>LOCATION</p> <ul style="list-style-type: none"> IMAGE (Object) <p>SOURCE</p> <ul style="list-style-type: none"> Constant
BAND_STORAGE_TYPE	Specifies the storage sequence of lines, samples and bands in an image. The values describe, for example, how different samples are interleaved in image lines, or how samples from different bands are arranged sequentially.	string(20)		"BAND_SEQUENTIAL", "SAMPLE_INTERLEAVED", "LINE_INTERLEAVED"	<p>LOCATION</p> <ul style="list-style-type: none"> IMAGE (Object) <p>SOURCE</p> <ul style="list-style-type: none"> Constant
BIAS_COEFFS_FILE	Specifies the name of bias coefficients file used in generating the RDR.	string			<p>LOCATION</p> <ul style="list-style-type: none"> DERIVED_IMAGE_PARMS (Group) <p>SOURCE</p> <ul style="list-style-type: none"> Image Processing Software

Keyword Name	Definition	Type	Units	Valid Values	<ul style="list-style-type: none"> Location in PDS Label Source
BIAS_COEFFS_FILE_DESCRIPTION	Specifies a description of bias coefficients file named in BIAS_COEFFS_FILE.	string			LOCATION <ul style="list-style-type: none"> DERIVED_IMAGE_PARMS (Group) SOURCE <ul style="list-style-type: none"> Image Processing Software
BYTES	Specifies the number of bytes allocated for a particular data representation.	integer		"0" to n	LOCATION <ul style="list-style-type: none"> IMAGE_HEADER (Object) SOURCE <ul style="list-style-type: none"> Calculation: <ul style="list-style-type: none"> Based on size of the VICAR label.
CALIBRATION_SOURCE_ID	<p>Specifies a unique identifier (within a data set) indicating the source of the calibration data used in generating the entity described by the enclosing group (often, a camera model).</p> <p>The construction of this identifier is mission-specific, but should indicate which specific calibration data set was used (via date or other means) and may also indicate the calibration method.</p>	string(47)			LOCATION <ul style="list-style-type: none"> GEOMETRIC_CAMERA_MODEL (Group) SOURCE <ul style="list-style-type: none"> Convert to string: <ul style="list-style-type: none"> IDPH:ImgTImHdr:cmodel.model_id
CAMERA_LOCATION_ID	<p>Specifies where the camera was during data acquisition.</p> <p>Used in MER calibration data to denote the location of the camera on the mounted bracket.</p>	integer			LOCATION <ul style="list-style-type: none"> GROUND_SUPPORT_EQUIPMENT (Group) SOURCE <ul style="list-style-type: none"> GSE Software
CHECKSUM	Specifies an unsigned 32-bit sum of all data values in a data object.	float		"0" to "4294967295"	LOCATION <ul style="list-style-type: none"> IMAGE (Object) SOURCE <ul style="list-style-type: none"> Calculation
COMMAND_INSTRUMENT_ID	<p>Specifies an abbreviated name or acronym which identifies the instrument that was commanded.</p> <p>Note: INSTRUMENT_ID is not a unique identifier for a given instrument. Note also that the associated INSTRUMENT_NAME element provides the full name of the instrument.</p> <p>Example values: IRTM (for Viking Infrared Thermal Mapper), PWS (for plasma wave</p>	string(20)		0 = "NONE" 1 = "FRONT_HAZCAM_LEFT" 2 = "FRONT_HAZCAM_RIGHT" 3 = "REAR_HAZCAM_LEFT" 4 = "REAR_HAZCAM_RIGHT" 5 = "NAVCAM_LEFT" 6 = "NAVCAM_RIGHT" 7 = "PANCAM_LEFT" 8 = "PANCAM_RIGHT" 9 = "DESCAM" 10 = "MI"	LOCATION <ul style="list-style-type: none"> OBSERVATION_REQUEST_PARMS (Group) SOURCE <ul style="list-style-type: none"> Table Lookup: <ul style="list-style-type: none"> IDPH:ImgParams:camera

Keyword Name	Definition	Type	Units	Valid Values	<ul style="list-style-type: none"> Location in PDS Label Source
	spectrometer).				
COMMAND_SEQUENCE_NUMBER	<p>Specifies a numeric identifier for a sequence of commands sent to a spacecraft or instrument.</p> <p>Note: For MER, this is the command number which identifies the specific generating command within the specified sequence.</p>	integer			<p>LOCATION</p> <ul style="list-style-type: none"> IDENTIFICATION (Class) <p>SOURCE</p> <ul style="list-style-type: none"> Command Number: <ul style="list-style-type: none"> UPTH:ProdCmndId
CONFIGURATION_BAND_ID	<p>Specifies an array of strings identifying the configuration of the IDD arm represented by the corresponding band in the image. The first entry in the array identifies the configuration for the first band, the second entry for the second band, etc. See also INSTRUMENT_BAND_ID.</p>	string array[16]		<p><u>Microscopic Imager</u></p> <p>1 = "ELBOW_UP_WRIST_UP" 2 = "ELBOW_UP_WRIST_DOWN" 3 = "ELBOW_DOWN_WRIST_UP" 4 = "ELBOW_DOWN_WRIST_DOWN"</p> <p><u>RAT</u></p> <p>5 = "ELBOW_UP_WRIST_UP" 6 = "ELBOW_UP_WRIST_DOWN" 7 = "ELBOW_DOWN_WRIST_UP" 8 = "ELBOW_DOWN_WRIST_DOWN"</p> <p><u>Mossbauer</u></p> <p>9 = "ELBOW_UP_WRIST_UP" 10 = "ELBOW_UP_WRIST_DOWN" 11 = "ELBOW_DOWN_WRIST_UP" 12 = "ELBOW_DOWN_WRIST_DOWN"</p> <p><u>APXS</u></p> <p>13 = "ELBOW_UP_WRIST_UP" 14 = "ELBOW_UP_WRIST_DOWN" 15 = "ELBOW_DOWN_WRIST_UP" 16 = "ELBOW_DOWN_WRIST_DOWN"</p>	<p>LOCATION</p> <ul style="list-style-type: none"> DERIVED_IMAGE_PARMS (Group) <p>SOURCE</p> <ul style="list-style-type: none"> Static value
CONTACT_SENSOR_STATE	<p>Specifies an array of identifiers for the state of an instrument or an instrument host's contact sensors at a specified time.</p>	string array[8]		<p>0 = "NO CONTACT" or "CLOSED" 1 = "CONTACT" or "OPEN"</p>	<p>LOCATION</p> <ul style="list-style-type: none"> IDD_ARTICULATION_STATE (Group)

Keyword Name	Definition	Type	Units	Valid Values	<ul style="list-style-type: none"> Location in PDS Label Source
	Note: For MER, the values corresponding to APXS DOOR SWITCH (array position 7 only) are OPEN or CLOSED. Other array position values are CONTACT or NO CONTACT"			"CONTACT" or "NO CONTACT" for all array positions except for position 7, which would be "OPEN" or "CLOSED"	SOURCE <ul style="list-style-type: none"> Table Lookup: <ul style="list-style-type: none"> IDPH:ImgTlmHdr:idd.contact (bit map)
CONTACT_SENSOR_STATE_NAME	Specifies the possible value that can be contained in the CONTACT_SENSOR_STATE array.	string array[8]		("MI SWITCH 1", "MI SWITCH 2", "RAT SWITCH 1", "RAT SWITCH 2", "MB SWITCH 1", "MB SWITCH 2", "APXS DOOR SWITCH", "APXS CONTACT SWITCH")	LOCATION <ul style="list-style-type: none"> IDD_ARTICULATION_STATE (Group) SOURCE <ul style="list-style-type: none"> Static Value
COORDINATE_SYSTEM_INDEX	<p>Specifies an integer array used to record and track the movement of a rover during surface operations. When in a COORDINATE_SYSTEM_STATE group, this keyword identifies which instance of the coordinate frame, named by COORDINATE_SYSTEM_NAME, is being defined by the group.</p> <p>Note: For MER, the indices are based on the ROVER_MOTION_COUNTER. This counter is incremented each time the rover moves (or may potentially have moved, e.g. due to arm motion). The full counter may have up to 5 values (SITE, DRIVE, IDD, PMA, HGA), but normally only the first value (for SITE frames) or the first two values (for LOCAL_LEVEL or ROVER frames) are used for defining coordinate system instances. It is legal to use any number of indices to describe a coordinate system instance, however.</p> <p>Example: COORDINATE_SYSTEM_INDEX = (1,3,2,3,2)</p>	integer array[6]			LOCATION <ul style="list-style-type: none"> ROVER COORDINATE_SYSTEM (Group) IDD_COORDINATE_SYSTEM (Group) PMA_COORDINATE_SYSTEM (Group) LOCAL_LEVEL_COORDINATE_SYSTEM (Group) SITE_COORDINATE_SYSTEM (Group) SOURCE <ul style="list-style-type: none"> Calculation: <ul style="list-style-type: none"> IDPH:ImgTlmHdr:rmc COORDINATE_SYSTEM_NAME NOTES: <ul style="list-style-type: none"> <u>Defaults for EDRs</u> <ul style="list-style-type: none"> If ROVER_FRAME, then SITE, DRIVE, IDD, PMA, and HGA indices If SITE_FRAME, then SITE index If MAST_FRAME, then SITE, DRIVE, IDD, PMA, and HGA indices If LOCAL_LEVEL_FRAME, then SITE, DRIVE, IDD, PMA, and HGA indices APXS_FRAME MB_FRAME MI_FRAME If RAT_FRAME, then SITE, DRIVE, IDD, PMA, and HGA indices <u>Defaults for RDRs</u> <ul style="list-style-type: none"> Software and activity dependent.
COORDINATE_SYSTEM_INDEX_NAME	Specifies an array of the formal names identifying each integer specified in COORDINATE_SYSTEM_INDEX.	string array[6]		("SITE", "DRIVE", "IDD", "PMA", "HGA")	LOCATION <ul style="list-style-type: none"> Group Dependent: <ol style="list-style-type: none"> ROVER COORDINATE_SYSTEM (Group)

Keyword Name	Definition	Type	Units	Valid Values	<ul style="list-style-type: none"> Location in PDS Label Source
					<ul style="list-style-type: none"> b) IDD_COORDINATE_SYSTEM (Group) c) PMA_COORDINATE_SYSTEM (Group) d) LOCAL_LEVEL_COORDINATE_SYSTEM (Group) e) SITE_COORDINATE_SYSTEM (Group) <p>SOURCE</p> <ul style="list-style-type: none"> Group Dependent, Static Value: <ul style="list-style-type: none"> Should match the number of values in COORDINATE_SYSTEM_INDEX.
COORDINATE_SYSTEM_NAME	<p>Specifies the full name of the coordinate system to which the state vectors are referenced.</p> <p>When in a COORDINATE_SYSTEM group, this keyword provides the full name of the coordinate system being defined by the group. The rest of the keywords in the group describe how this coordinate system is related to some other (the "reference"). Non-unique coordinate systems (such as "SITE" for rover missions), which have multiple instances using the same name, also require COORDINATE_SYSTEM_INDEX to completely identify the coordinate system.</p>	string(30)		<p>"ROVER_FRAME", "SITE_FRAME", "MAST_FRAME", "LOCAL_LEVEL_FRAME",</p> <p><u>IDD only</u> 0 = "MI_FRAME" 1 = "RAT_FRAME" 2 = "MB_FRAME" 3 = "APXS_FRAME"</p>	<p>LOCATION</p> <ul style="list-style-type: none"> Group Dependent: <ul style="list-style-type: none"> a) ROVER_COORDINATE_SYSTEM (Group) b) IDD_COORDINATE_SYSTEM (Group) c) PMA_COORDINATE_SYSTEM (Group) d) LOCAL_LEVEL_COORDINATE_SYSTEM (Group) e) SITE_COORDINATE_SYSTEM (Group) <p>SOURCE</p> <ul style="list-style-type: none"> Group Dependent, Static Value: <ul style="list-style-type: none"> a) ROVER_FRAME b) one of the IDD only frames based on IDPH:ImgTlmHdr:idd_instrument c) MAST_FRAME d) LOCAL_LEVEL_FRAME e) SITE_FRAME
DARK_CURRENT_FILE	Specifies a list of the names of the dark current files used in generating the RDR.	string array			<p>LOCATION</p> <ul style="list-style-type: none"> DERIVED_IMAGE_PARMS (Group) <p>SOURCE</p> <ul style="list-style-type: none"> Image Processing Software
DARK_CURRENT_FILE_DESCRIPTION	Specifies a description of the corresponding dark current files listed in DARK_CURRENT_FILE.	string			<p>LOCATION</p> <ul style="list-style-type: none"> DERIVED_IMAGE_PARMS (Group) <p>SOURCE</p> <ul style="list-style-type: none"> Image Processing Software
DATA_SET_ID	<p>Specifies a unique alphanumeric identifier for a data set or a data product.</p> <p>The DATA_SET_ID value for a given data set or product is constructed according to flight project naming conventions. In most cases the DATA_SET_ID is an</p>	string(40)		<p><u>"Operations" EDRs</u> "MER<scid>-M-PANCAM-2-EDR-OPS-V1.0", "MER<scid>-M-NAVCAM-2-EDR-OPS-V1.0", "MER<scid>-M-HAZCAM-2-EDR-OPS-V1.0",</p>	<p>LOCATION</p> <ul style="list-style-type: none"> IDENTIFICATION (Class) <p>SOURCE</p> <ul style="list-style-type: none"> PDS Table Lookup: <ul style="list-style-type: none"> CCSDS:Primary:APID

Keyword Name	Definition	Type	Units	Valid Values	<ul style="list-style-type: none"> Location in PDS Label Source
	<p>abbreviation of the DATA_SET_NAME.</p> <p>In the PDS, the values for DATA_SET_ID are constructed according to standards outlined in the Standards Reference.</p>			<p>"MER<scid>-M-MI-2-EDR-OPS-V1.0", "MER<scid>-M-DESCAM-2-EDR-OPS-V1.0"</p> <p><u>"Science" EDRs</u> "MER<scid>-M-PANCAM-2-EDR-SCI-V1.0", "MER<scid>-M-MI-2-EDR-SCI-V1.0"</p> <p><u>"Operations" RDRs (Pancam)</u> "MER<scid>-M-PANCAM-3-ILUT-OPS-V1.0", "MER<scid>-M-PANCAM-3-RADIOMETRIC-OPS-V1.0", "MER<scid>-M-PANCAM-4-LINEARIZED-OPS-V1.0", "MER<scid>-M-PANCAM-5-DISPARITY-OPS-V1.0", "MER<scid>-M-PANCAM-5-XYZ-OPS-V1.0", "MER<scid>-M-PANCAM-5-NORMAL-OPS-V1.0", "MER<scid>-M-PANCAM-5-RANGE-OPS-V1.0", "MER<scid>-M-PANCAM-5-SLOPE-OPS-V1.0", "MER<scid>-M-PANCAM-5-ROUGHNESS-OPS-V1.0", "MER<scid>-M-PANCAM-5-WEDGE-OPS-V1.0", "MER<scid>-M-PANCAM-5-MESH-OPS-V1.0", "MER<scid>-M-PANCAM-5-MOSAIC-OPS-V1.0", "MER<scid>-M-PANCAM-5-ANAGLYPH-OPS-V1.0"</p> <p><u>"Operations" RDRs (Navcam)</u> "MER<scid>-M-NAVCAM-3-ILUT-OPS-V1.0", "MER<scid>-M-NAVCAM-3-RADIOMETRIC-OPS-V1.0", "MER<scid>-M-NAVCAM-4-LINEARIZED-OPS-V1.0", "MER<scid>-M-NAVCAM-5-</p>	<ul style="list-style-type: none"> - CHDO-82:scft_id

Keyword Name	Definition	Type	Units	Valid Values	<ul style="list-style-type: none"> • Location in PDS Label • Source
				<p>DISPARITY-OPS-V1.0", "MER<scid>-M-NAVCAM-5-XYZ-OPS-V1.0", "MER<scid>-M-NAVCAM-5-NORMAL-OPS-V1.0", "MER<scid>-M-NAVCAM-5-RANGE-OPS-V1.0", "MER<scid>-M-NAVCAM-5-SLOPE-OPS-V1.0", "MER<scid>-M-NAVCAM-5-ROUGHNESS-OPS-V1.0", "MER<scid>-M-NAVCAM-5-WEDGE-OPS-V1.0", "MER<scid>-M-NAVCAM-5-MESH-OPS-V1.0", "MER<scid>-M-NAVCAM-5-MOSAIC-OPS-V1.0", "MER<scid>-M-NAVCAM-5-ANAGLYPH-OPS-V1.0"</p> <p><u>"Operations" RDRs (Hazcam)</u> "MER<scid>-M-HAZCAM-3-ILUT-OPS-V1.0", "MER<scid>-M-HAZCAM-3-RADIOMETRIC-OPS-V1.0", "MER<scid>-M-HAZCAM-4-LINEARIZED-OPS-V1.0", "MER<scid>-M-HAZCAM-5-DISPARITY-OPS-V1.0", "MER<scid>-M-HAZCAM-5-XYZ-OPS-V1.0", "MER<scid>-M-HAZCAM-5-NORMAL-OPS-V1.0", "MER<scid>-M-HAZCAM-5-RANGE-OPS-V1.0", "MER<scid>-M-HAZCAM-5-SLOPE-OPS-V1.0", "MER<scid>-M-HAZCAM-5-ROUGHNESS-OPS-V1.0", "MER<scid>-M-HAZCAM-5-REACHABILITY-OPS-V1.0", "MER<scid>-M-HAZCAM-5-WEDGE-OPS-V1.0", "MER<scid>-M-HAZCAM-5-MESH-OPS-V1.0"</p> <p><u>"Operations" RDRs (MI)</u></p>	

Keyword Name	Definition	Type	Units	Valid Values	<ul style="list-style-type: none"> Location in PDS Label Source
				"MER<scid>-M-MI-3-ILUT-OPS-V1.0", "MER<scid>-M-MI-3-RADIOMETRIC-OPS-V1.0", "MER<scid>-M-MI-4-LINEARIZED-OPS-V1.0", "MER<scid>-M-MI-5-MOSAIC-OPS-V1.0", "MER<scid>-M-MI-5-ANAGLYPH-OPS-V1.0" <u>"Operations" RDRs (other)</u> "MER<scid>-M-RVRCAM-6-RMC-OPS-V1.0"	
DATA_SET_NAME	<p>Specifies the full name given to a data set or a data product.</p> <p>The DATA_SET_NAME typically identifies the instrument that acquired the data, the target of that instrument, and the processing level of the data.</p> <p>In the PDS, values for DATA_SET_NAME are constructed according to standards outlined in the Standards Reference.</p>	string		<u>"Operations" EDRs</u> "MER <scid> MARS PANORAMIC CAMERA EDR OPS VERSION 1.0", "MER <scid> MARS NAVIGATION CAMERA EDR OPS VERSION 1.0", "MER <scid> MARS HAZARD AVOIDANCE CAMERA EDR OPS VERSION 1.0", "MER <scid> MARS MICROSCOPIC IMAGER CAMERA EDR OPS VERSION 1.0", "MER <scid> MARS DESCENT CAMERA EDR OPS VERSION 1.0" <u>"Science" EDRs</u> "MER <scid> MARS PANORAMIC CAMERA SCIENCE EDR VERSION 1.0", "MER <scid> MARS MICROSCOPIC IMAGER CAMERA SCIENCE EDR VERSION 1.0" <u>"Operations" RDRs (Pancam)</u> "MER <scid> MARS PANORAMIC CAMERA INVERSE LUT RDR OPS V1.0", "MER <scid> MARS	<p>LOCATION</p> <ul style="list-style-type: none"> IDENTIFICATION (Class) <p>SOURCE</p> <ul style="list-style-type: none"> PDS Table Lookup: <ul style="list-style-type: none"> - CCSDS:Primary:APID - CHDO-82:scft_id

Keyword Name	Definition	Type	Units	Valid Values	<ul style="list-style-type: none"> • Location in PDS Label • Source
				PANORAMIC CAMERA RADIOMETRIC RDR OPS V1.0", "MER <scid> MARS PANORAMIC CAMERA LINEARIZED RDR OPS V1.0", "MER <scid> MARS PANORAMIC CAMERA DISPARITY RDR OPS V1.0", "MER <scid> MARS PANORAMIC CAMERA XYZ RDR OPS V1.0", "MER <scid> MARS PANORAMIC CAMERA NORMAL RDR OPS V1.0", "MER <scid> MARS PANORAMIC CAMERA RANGE RDR OPS V1.0", "MER <scid> MARS PANORAMIC CAMERA SLOPE RDR OPS V1.0", "MER <scid> MARS PANORAMIC CAMERA ROUGHNESS RDR OPS V1.0", "MER <scid> MARS PANORAMIC CAMERA TERRAIN WEDGE RDR OPS V1.0", "MER <scid> MARS PANORAMIC CAMERA TERRAIN MESH RDR OPS V1.0", "MER <scid> MARS PANORAMIC CAMERA MOSAIC RDR OPS V1.0", "MER <scid> MARS PANORAMIC CAMERA ANAGLYPH RDR OPS V1.0" <u>"Operations" RDRs (Navcam)</u> "MER <scid> MARS NAVIGATION CAMERA INVERSE LUT RDR OPS V1.0", "MER <scid> MARS NAVIGATION CAMERA RADIOMETRIC RDR OPS	

Keyword Name	Definition	Type	Units	Valid Values	<ul style="list-style-type: none"> • Location in PDS Label • Source
				V1.0", "MER <scid> MARS NAVIGATION CAMERA LINEARIZED RDR OPS V1.0", "MER <scid> MARS NAVIGATION CAMERA DISPARITY RDR OPS V1.0", "MER <scid> MARS NAVIGATION CAMERA XYZ RDR OPS V1.0", "MER <scid> MARS NAVIGATION CAMERA NORMAL RDR OPS V1.0", "MER <scid> MARS NAVIGATION CAMERA RANGE RDR OPS V1.0", "MER <scid> MARS NAVIGATION CAMERA SLOPE RDR OPS V1.0", "MER <scid> MARS NAVIGATION CAMERA ROUGHNESS RDR OPS V1.0", "MER <scid> MARS NAVIGATION CAMERA TERRAIN WEDGE RDR OPS V1.0", "MER <scid> MARS NAVIGATION CAMERA TERRAIN MESH RDR OPS V1.0", "MER <scid> MARS NAVIGATION CAMERA MOSAIC RDR OPS V1.0", "MER <scid> MARS NAVIGATION CAMERA ANAGLYPH RDR OPS V1.0" <u>"Operations" RDRs (Hazcam)</u> "MER <scid> MARS HAZARD AVOID CAMERA INVERSE LUT RDR OPS V1.0", "MER <scid> MARS HAZARD AVOID CAMERA RADIOMETRIC RDR OPS V1.0", "MER <scid> MARS HAZARD AVOID CAMERA LINEARIZED	

Keyword Name	Definition	Type	Units	Valid Values	<ul style="list-style-type: none"> • Location in PDS Label • Source
				RDR OPS V1.0", "MER <scid> MARS HAZARD AVOID CAMERA DISPARITY RDR OPS V1.0", "MER <scid> MARS HAZARD AVOID CAMERA XYZ RDR OPS V1.0", "MER <scid> MARS HAZARD AVOID CAMERA NORMAL RDR OPS V1.0", "MER <scid> MARS HAZARD AVOID CAMERA RANGE RDR OPS V1.0", "MER <scid> MARS HAZARD AVOID CAMERA SLOPE RDR OPS V1.0", "MER <scid> MARS HAZARD AVOID CAMERA ROUGHNESS RDR OPS V1.0", "MER <scid> MARS HAZARD AVOID CAMERA REACHABILITY RDR OPS V1.0", "MER <scid> MARS HAZARD AVOID CAMERA TERRAIN WEDGE RDR OPS V1.0", "MER <scid> MARS HAZARD AVOID CAMERA TERRAIN MESH RDR OPS V1.0" <u>"Operations" RDRs (MI)</u> "MER <scid> MARS MICROSCOPIC IMAGER CAMERA INVERSE LUT RDR OPS V1.0", "MER <scid> MARS MICROSCOPIC IMAGER CAMERA RADIOMETRIC RDR OPS V1.0", "MER <scid> MARS MICROSCOPIC IMAGER CAMERA LINEARIZED RDR OPS V1.0", "MER <scid> MARS MICROSCOPIC IMAGER CAMERA MOSAIC RDR OPS V1.0",	

Keyword Name	Definition	Type	Units	Valid Values	<ul style="list-style-type: none"> Location in PDS Label Source
				"MER <scid> MARS MICROSCOPIC IMAGER CAMERA ANAGLYPH RDR OPS V1.0" <u>"Operations" RDRs (other)</u> "MER <scid> MARS ROVER CAMERAS ROVER MOTION COUNTER RDR OPS V1.0"	
DERIVED_IMAGE_TYPE	<p>Specifies how to interpret the pixel values in a derived image RDR (or colloquially, the type of the derived image itself).</p> <p>Values are defined as:</p> <p>IMAGE - Standard image, where pixels represent intensity. Note: This implies nothing about radiometric, geometric, or other corrections that may have been applied.</p> <p>DISPARITY_MAP - Pixels represent line and sample disparity with respect to another image (2 bands).</p> <p>DISPARITY_LINE_MAP - Pixels represent line disparity only.</p> <p>DISPARITY_SAMPLE_MAP - Pixels represent sample disparity only.</p> <p>XYZ_MAP - Pixels represent XYZ values (3 bands).</p> <p>X_MAP - Pixels represent the X component of an XYZ image.</p> <p>Y_MAP - Pixels represent the Y component of an XYZ image.</p> <p>Z_MAP - Pixels represent the Z component of an XYZ image.</p> <p>RANGE_MAP - Pixels represent a distance from the camera center.</p> <p>UVW_MAP - Pixels represent Surface</p>	string		"IMAGE", "DISPARITY_MAP", "DISPARITY_LINE_MAP", "DISPARITY_SAMPLE_MAP", "XYZ_MAP", "X_MAP", "Y_MAP", "Z_MAP", "RANGE_MAP", "UVW_MAP", "U_MAP", "V_MAP", "W_MAP", "ROUGHNESS_MAP", "REACHABILITY_MAP"	<p>LOCATION</p> <ul style="list-style-type: none"> DERIVED_IMAGE_PARMS (Group) <p>SOURCE</p> <ul style="list-style-type: none"> Image processing software

Keyword Name	Definition	Type	Units	Valid Values	<ul style="list-style-type: none"> Location in PDS Label Source
	<p>Normal values (3 bands associating to X,Y,Z).</p> <p>U_MAP - Pixels represent the U (X) component of a Surface Normal image.</p> <p>V_MAP - Pixels represent the V (Y) component of a Surface Normal image.</p> <p>W_MAP - Pixels represent the W (Z) component of a Surface Normal image.</p> <p>ROUGHNESS_MAP - Pixels represent a measure of surface roughness.</p> <p>REACHABILITY_MAP - Pixels flag what is reachable on the target feature by the respective IDD instrument.</p>				
^DESCRIPTION	Specifies a pointer that provides a free-form, unlimited-length character string that represents or gives an account of something.	string		"VICAR2.TXT"	<p>LOCATION</p> <ul style="list-style-type: none"> IMAGE_HEADER (Object) <p>SOURCE</p> <ul style="list-style-type: none"> Static Value
DETECTOR_ERASE_COUNT	Specifies the number of times a detector has been flushed of data in raw counts.	integer		"0" to "15"	<p>LOCATION</p> <ul style="list-style-type: none"> OBSERVATION_REQUEST_PARMS (Group) <p>SOURCE</p> <ul style="list-style-type: none"> IDPH:ImgParams:flush
DETECTOR_FIRST_LINE	Specifies the starting row from the hardware, such as a charge-coupled device (CCD), that contains data.	integer		"1" to "1024"	<p>LOCATION</p> <ul style="list-style-type: none"> INSTRUMENT_STATE_PARMS (Group) <p>SOURCE</p> <ul style="list-style-type: none"> IDPH:ImgTImHdr:hw_minrow
DETECTOR_LINES	Specifies the number of rows extracted from the hardware, such as a charge-coupled device (CCD), that contain data.	integer		"0" to "1024"	<p>LOCATION</p> <ul style="list-style-type: none"> INSTRUMENT_STATE_PARMS (Group) <p>SOURCE</p> <ul style="list-style-type: none"> IDPH:ImgTImHdr:hw_numrows
DETECTOR_TO_IMAGE_ROTATION	Specifies the clockwise rotation, in degrees, that was applied to an image along its optical path through an instrument, from detector to final image orientation.	float	deg	0 = "0.0" 1 = "90.0" 2 = "180.0" 3 = "270.0"	<p>LOCATION</p> <ul style="list-style-type: none"> INSTRUMENT_STATE_PARMS (Group) <p>SOURCE</p> <ul style="list-style-type: none"> Table Lookup: <ul style="list-style-type: none"> IDPH:ImgTImHdr:rotation

Keyword Name	Definition	Type	Units	Valid Values	<ul style="list-style-type: none"> Location in PDS Label Source
DOWNLOAD_PRIORITY	<p>Specifies which data to downlink/transmit, based on order of importance. The lower numerical priority (higher-ranked number) data products are transmitted before higher numerical priority (lower-ranked number) data products.</p> <p>For example, an image with a downlink priority of 25 will be transmitted from the rover before an image with a downlink priority of 50.</p>	integer		"0" to "100"	<p>LOCATION</p> <ul style="list-style-type: none"> Group Dependent: <ul style="list-style-type: none"> a) IMAGE_REQUEST_PARMS (Group) b) THUMBNAIL_REQUEST_PARMS (Group) c) COLUMN_SUM_REQUEST_PARMS (Group) d) ROW_SUM_REQUEST_PARMS (Group) e) HISTOGRAM_REQUEST_PARMS (Group) f) REFERENCE_PIXEL_REQUEST_PARMS (Group) <p>SOURCE</p> <ul style="list-style-type: none"> Group Dependent: <ul style="list-style-type: none"> a) IDPH:ImgParams:img_prio b) IDPH:ImgParams:thumb_prio c) IDPH:ImgParams:col_prio d) IDPH:ImgParams:row_prio e) IDPH:ImgParams:hist_prio f) IDPH:ImgParams:ref_prio
DOWNSAMPLE_METHOD	Specifies whether or not hardware downsampling was applied to an image.	string		"HARDWARE", "SOFTWARE", "BOTH", "NONE"	<p>LOCATION</p> <ul style="list-style-type: none"> INSTRUMENT_STATE_PARMS (Group) <p>SOURCE</p> <ul style="list-style-type: none"> Calculation: <ul style="list-style-type: none"> - IDPH:ImgTImHdr:hw_binning - IDPH:ImgTImHdr:rotation - IDPH:ImgTImHdr:res_rows - IDPH:ImgTImHdr:res_cols <p>NOTES:</p> <ul style="list-style-type: none"> - If res_rows = 1 and res_cols=1 then NONE - If hw_binning is false then SOFTWARE - If hw_binning is TRUE and (rotation=0 or 2 and res_rows=4 and res_cols=1) or (rotation=1 or 3 and res_rows=1 and res_cols=4) then HARDWARE - If hw_binning is TRUE and you get res_rows and res_cols as something else then BOTH.
EARLY_IMAGE_RETURN_FLAG	Specifies the deferral of on-board post processing of the image and the returns the image early to an onboard client.	string		0 = "FALSE" 1 = "TRUE"	<p>LOCATION</p> <ul style="list-style-type: none"> OBSERVATION_REQUEST_PARMS (Group) <p>SOURCE</p>

Keyword Name	Definition	Type	Units	Valid Values	<ul style="list-style-type: none"> Location in PDS Label Source
					<ul style="list-style-type: none"> Table Lookup: <ul style="list-style-type: none"> IDPH:ImgParams:img_early
EARLY_PIXEL_SCALE_FLAG	Specifies the scaling of pixels. If TRUE, pixels are scaled early (from 12 to 8 bits).	string		0 = "FALSE" 1 = "TRUE"	<p>LOCATION</p> <ul style="list-style-type: none"> OBSERVATION_REQUEST_PARMS (Group) <p>SOURCE</p> <ul style="list-style-type: none"> Table Lookup: <ul style="list-style-type: none"> IDPH:ImgParams:scale_early
EARTH_RECEIVED_START_TIME	Specifies the beginning time at which telemetry was received during a time period of interest. This should be represented in UTC system format.	datetime		YYYY-MM-DDThh:mm:ss[.fff]Z	<p>LOCATION</p> <ul style="list-style-type: none"> TELEMETRY (Class) <p>SOURCE</p> <ul style="list-style-type: none"> Calculation: <ul style="list-style-type: none"> CHDO_82:ert
EARTH_RECEIVED_STOP_TIME	Specifies the ending time for receiving telemetry during a time period of interest. This should be represented in UTC system format.	datetime		YYYY-MM-DDThh:mm:ss[.fff]Z	<p>LOCATION</p> <ul style="list-style-type: none"> TELEMETRY (Class) <p>SOURCE</p> <ul style="list-style-type: none"> Calculation: <ul style="list-style-type: none"> CHDO_82:ert
ELEVATION_FOV	Specifies the angular measure of the vertical field of view of an imaged scene.	float	deg		<p>LOCATION</p> <ul style="list-style-type: none"> INSTRUMENT_STATE_PARMS (Group) <p>SOURCE</p> <ul style="list-style-type: none"> Calculation: <ul style="list-style-type: none"> IDPH:ImgTImHdr:res_rows IDPH:ImgTImHdr:rows
ERROR_PIXELS	Specifies the number of pixels that are outside a valid DN range, after all decompression and post decompression processing has been completed.	integer			<p>LOCATION</p> <ul style="list-style-type: none"> COMPRESSION_PARMS (Group) <p>SOURCE</p> <ul style="list-style-type: none"> Calculated by telemetry
EXPECTED_PACKETS	Specifies the total number of telemetry packets which constitute a complete data product, i.e., a data product without missing data. For MER, "Packets" are also referred to as "Parts".	integer			<p>LOCATION</p> <ul style="list-style-type: none"> TELEMETRY (Class) <p>SOURCE</p> <ul style="list-style-type: none"> UPTH:TotalParts
EXPOSURE_COUNT	Specifies the maximum number of exposures taken during a specified interval. The value is dependent on exposure type.	integer		"0" to "255"	<p>LOCATION</p> <ul style="list-style-type: none"> Group Dependent: <ol style="list-style-type: none"> INSTRUMENT_STATE_PARMS (Group) GROUND_SUPPORT_EQUIPMENT (Group)

Keyword Name	Definition	Type	Units	Valid Values	<ul style="list-style-type: none"> Location in PDS Label Source
					SOURCE <ul style="list-style-type: none"> Group Dependent: <ul style="list-style-type: none"> a) IDPH:ImgTImHdr:exp_count b) GSE software
EXPOSURE_DURATION	<p>Specifies the value of the time between the opening and closing of an instrument aperture (such as a camera shutter).</p> <p>For MER, there are no mechanical shutters. Instead, an "electronic shutter" concept was adopted whereby the detectors accumulate charge for EXPOSURE_DURATION amount of time and then that charge is flushed to a masked frame transfer area for readout and digitization. Refer to the Pancam Calibration Report [Ref 14] or Pancam JGR paper [Ref 15] for more details.</p>	float	ms (<ms> unit tag required)		LOCATION <ul style="list-style-type: none"> Group Dependent: <ul style="list-style-type: none"> a) INSTRUMENT_STATE_PARMS (Group) b) GROUND_SUPPORT_EQUIPMENT (Group) SOURCE <ul style="list-style-type: none"> Calculation: <ul style="list-style-type: none"> a) IDPH:ImgTImHdr:exp_time (in ms) b) GSE software
EXPOSURE_DURATION_COUNT	<p>Specifies the value, in raw counts, of the time interval between the opening and closing of an instrument aperture (such as a camera shutter). This is a raw value taken directly from telemetry, as opposed to EXPOSURE_DURATION, which has been converted to engineering units.</p> <p>For MER, one count is equivalent to 5.12 ms.</p>	integer		"0" to "65535"	LOCATION <ul style="list-style-type: none"> Group Dependent: <ul style="list-style-type: none"> a) OBSERVATION_REQUEST_PARMS (Group) b) INSTRUMENT_STATE_PARMS (Group) SOURCE <ul style="list-style-type: none"> Group Dependent: <ul style="list-style-type: none"> a) IDPH:ImgParams:exp_time b) IDPH:ImgTImHdr:exp_time
EXPOSURE_SCALE_FACTOR	<p>Specifies a multiplier to the base exposure time. The base exposure time is either user-commanded or is read from the onboard exposure time table. The resulting number is used by the cameras as the actual commanded exposure time. This scale factor is commonly used during multi-spectral imaging, when the base exposure time is known for one filter and EXPOSURE_SCALE_FACTOR is used to scale the exposure time to levels appropriate for the other filters.</p> <p>For MER, refer to the MER FDD document [Ref 3] for a more complete definition.</p>	double			LOCATION <ul style="list-style-type: none"> OBSERVATION_REQUEST_PARMS (Group) SOURCE <ul style="list-style-type: none"> IDPH:ImgParams:exp_time_scale
EXPOSURE_TABLE_ID	Specifies a description for the exposure count value.	string		0 = "NONE" 1 = "FHAZCAM_L"	LOCATION <ul style="list-style-type: none"> OBSERVATION_REQUEST_PARMS

Keyword Name	Definition	Type	Units	Valid Values	<ul style="list-style-type: none"> Location in PDS Label Source
	For MER, refer to the MER FDD Volume 30, Imaging [Ref 3] for a more detailed description.			2 = "FHAZCAM_R" 3 = "RHAZCAM_L" 4 = "RHAZCAM_R" 5 = "NAVCAM_L" 6 = "NAVCAM_R" 7 = "PANCAM_L1" 8 = "PANCAM_L2" 9 = "PANCAM_L3" 10 = "PANCAM_L4" 11 = "PANCAM_L5" 12 = "PANCAM_L6" 13 = "PANCAM_L7" 14 = "PANCAM_L8" 15 = "PANCAM_R1" 16 = "PANCAM_R2" 17 = "PANCAM_R3" 18 = "PANCAM_R4" 19 = "PANCAM_R5" 20 = "PANCAM_R6" 21 = "PANCAM_R7" 22 = "PANCAM_R8" 23 = "EDL" 24 = "MI_CLOSED" 25 = "MI_OPEN"	(Group) SOURCE <ul style="list-style-type: none"> Table Lookup: <ul style="list-style-type: none"> IDPH:ImgParams:exp_table
EXPOSURE_TBL_UPDATE_FLAG	Specifies whether or not an exposure table entry was updated.	string		0 = "FALSE" 1 = "TRUE"	LOCATION <ul style="list-style-type: none"> OBSERVATION_REQUEST_PARMS (Group) SOURCE <ul style="list-style-type: none"> Table Lookup: <ul style="list-style-type: none"> IDPH:ImgParams:exp_update
EXPOSURE_TYPE	Specifies the exposure mode used for image acquisition.	string(15)		0 = "NONE" 1 = "MANUAL" 2 = "AUTO" 3 = "TEST_MODE"	LOCATION <ul style="list-style-type: none"> OBSERVATION_REQUEST_PARMS (Group) SOURCE <ul style="list-style-type: none"> Table Lookup: <ul style="list-style-type: none"> IDPH:ImgParams:exposure
FACILITY_NAME	Specifies a department, laboratory, or subsystem that exists within an institution from which the data were acquired.	string			LOCATION <ul style="list-style-type: none"> GROUND_SUPPORT_EQUIPMENT (Group) SOURCE <ul style="list-style-type: none"> GSE software
FILE_RECORDS	Specifies the number of physical file records, including both label records and data records. Note: In the PDS the use of	integer		"0" to n	LOCATION <ul style="list-style-type: none"> FILE DATA ELEMENT (Class)

Keyword Name	Definition	Type	Units	Valid Values	<ul style="list-style-type: none"> Location in PDS Label Source
	FILE_RECORDS along with other file-related data elements is fully described in the Standards Reference.				SOURCE <ul style="list-style-type: none"> Calculation: <ul style="list-style-type: none"> IDPH:ImgTImHdr:rows + size of PDS and VICAR labels
FILTER_NAME	<p>Specifies the commonly-used name of the instrument filter through which an image or measurement was acquired or which is associated with a given instrument mode.</p> <p>See also FILTER_NUMBER.</p> <p>NOTE: FILTER_NAME is unique, while the FILTER_NUMBER is not.</p>	string array		IDPH Keyword Value 0 "NONE" 1 "PANCAM_L1_EMPTY" 2 "PANCAM_L2_753NM" 3 "PANCAM_L3_673NM" 4 "PANCAM_L4_602NM" 5 "PANCAM_L5_535NM" 6 "PANCAM_L6_483NM" 7 "PANCAM_L7_440NM" 8 "PANCAM_L8_440NM_SOL_ND5" 9 "PANCAM_R1_440NM" 10 "PANCAM_R2_754NM" 11 "PANCAM_R3_803NM" 12 "PANCAM_R4_864NM" 13 "PANCAM_R5_903NM" 14 "PANCAM_R6_933NM" 15 "PANCAM_R7_1001NM" 16 "PANCAM_R8_880NM_SOL_ND5" 17 "MI_CLOSED" (cover) 18 "MI_OPEN" (cover)	LOCATION <ul style="list-style-type: none"> Group Dependent: <ul style="list-style-type: none"> a) GEOMETRIC_CAMERA_MODEL (Group) b) OBSERVATION_REQUEST_PARMS (Group) c) INSTRUMENT_STATE_PARMS (Group) SOURCE <ul style="list-style-type: none"> Group Dependent: <ul style="list-style-type: none"> a) Table Lookup: <ul style="list-style-type: none"> IDPH:ImgCMod::filter b) Table Lookup: <ul style="list-style-type: none"> IDPH:ImgParms::filter c) Table Lookup: <ul style="list-style-type: none"> IDPH:ImgTImHdr:pma_filter_l, IDPH:ImgTImHdr:pma_filter_r, IDPH:ImgTImHdr:mi_filter
FILTER_NUMBER	<p>Specifies the number of an instrument filter through which an image or measurement was acquired or which is associated with a given instrument mode.</p> <p>See also FILTER_NAME.</p> <p>Note: FILTER_NAME is unique, while the FILTER_NUMBER is not.</p>	integer array		IDPH Keyword Value 0 "0" 1 "1" 2 "2" 3 "3" 4 "4" 5 "5" 6 "6" 7 "7" 8 "8" 9 "1" 10 "2" 11 "3" 12 "4" 13 "5" 14 "6" 15 "7" 16 "8" 17 "1" 18 "2"	LOCATION <ul style="list-style-type: none"> INSTRUMENT_STATE_PARMS (Group) SOURCE <ul style="list-style-type: none"> IDPH:ImgTImHdr:pma_filter_l, IDPH:ImgTImHdr:pma_filter_r, IDPH:ImgTImHdr:mi_filter
FIRST_LINE	Specifies the line within a source image	integer		"1" to "1024"	LOCATION

Keyword Name	Definition	Type	Units	Valid Values	<ul style="list-style-type: none"> Location in PDS Label Source
	that corresponds to the first line in a sub-image.				<ul style="list-style-type: none"> Group Dependent: <ol style="list-style-type: none"> SUBFRAME_REQUEST_PARMS (Group) IMAGE (Object) <p>SOURCE</p> <ul style="list-style-type: none"> Group Dependent: <ol style="list-style-type: none"> IDPH:ImgParams:sub_row0 IDPH:ImgTImHdr:row0
FIRST_LINE_SAMPLE	Specifies the sample within a source image that corresponds to the first sample in a sub-image.	integer		"1" to "1024"	<p>LOCATION</p> <ul style="list-style-type: none"> Group Dependent: <ol style="list-style-type: none"> SUBFRAME_REQUEST_PARMS (Group) IMAGE (Object) <p>SOURCE</p> <ul style="list-style-type: none"> Group Dependent: <ol style="list-style-type: none"> IDPH:ImgParams:sub_col0 IDPH:imgTImHdr:col0
FLAT_FIELD_CORRECTION_FLAG	Specifies whether or not a flat field correction was applied to an image.	string(13)		0 = "FALSE" 1 = "TRUE"	<p>LOCATION</p> <ul style="list-style-type: none"> Group Dependent: <ol style="list-style-type: none"> OBSERVATION_REQUEST_PARMS (Group) INSTRUMENT_STATE_PARMS (Group) <p>SOURCE</p> <ul style="list-style-type: none"> Group Dependent, Table Lookup: <ol style="list-style-type: none"> IDPH:ImgParams:flat IDPH:ImgTImHdr:flat_params[[5] (anyone greater than 1)
FLAT_FIELD_CORRECTION_PARM	Specifies the onboard flat-field coefficients/parameters used in the algorithm to remove the flat field signature. The FLAT_FIELD_CORRECTION_FLAG will indicate if the signature was removed. Note: The algorithm used by MER is the following: new(x,y) = orig(x,y) * ff(x,y) where, ff(x,y) = 1 + c*((x-a) ² + (y-b) ²) + d*((x-a) ² + (y-b) ²) ² + e*((x-a) ² + (y-b) ²) ³	float array[5]			<p>LOCATION</p> <ul style="list-style-type: none"> INSTRUMENT_STATE_PARMS (Group) <p>SOURCE</p> <ul style="list-style-type: none"> IDPH:ImgTImHdr:flat_params[5]
FLAT_FIELD_FILE	Specifies the array of names of the flat-field files used in generating the RDR.	string array			<p>LOCATION</p> <ul style="list-style-type: none"> DERIVED_IMAGE_PARMS (Group)

Keyword Name	Definition	Type	Units	Valid Values	<ul style="list-style-type: none"> Location in PDS Label Source
					SOURCE <ul style="list-style-type: none"> Image Processing Software
FLAT_FIELD_FILE_DESCRIPTION	Specifies a description of the corresponding flat field files listed in FLAT_FIELD_FILE.	string array		"Flat field image.", "Flat field standard deviation image."	LOCATION <ul style="list-style-type: none"> DERIVED_IMAGE_PARMs (Group) SOURCE <ul style="list-style-type: none"> Image Processing Software
FRAME_ID	Specifies an identification for a particular instrument measurement frame. A frame consists of a sequence of measurements made over a specified time interval, and may include measurements from different instrument modes. These sequences repeat from cycle to cycle and sometimes within a cycle. Note that mosaics may contain more than one value in an array.	string array		"LEFT", "RIGHT", "MONO"	LOCATION <ul style="list-style-type: none"> IDENTIFICATION (Class) SOURCE <ul style="list-style-type: none"> Table Lookup: <ul style="list-style-type: none"> - CCSDS:Primary:APID
FRAME_TYPE	Specifies whether the image was commanded as part of a stereo pair or as a single left or right monoscopic image. If FRAME_TYPE=STEREO, a left and a right image should be present for the same IMAGE_ID	string(10)		0 = "MONO" 1 = "STEREO"	LOCATION <ul style="list-style-type: none"> IDENTIFICATION (Class) SOURCE <ul style="list-style-type: none"> IDPH:ImgTImHdr:stereo
GEOMETRY_PROJECTION_TYPE	Specifies the state of the pixels in an image before a re-projection has been applied. Describes if or how the pixels have been reprojected. RAW indicates reprojection has not been done; the pixels are as they came from the camera. For MER, this means the image uses a CAHVOR or one of the CAHVORE camera models. LINEARIZED means that reprojection has been performed to linearize the camera model (thus removing things like lens distortion). For MER, this means the image uses a CAHV camera model.	string		"RAW", "LINEARIZED"	LOCATION <ul style="list-style-type: none"> IDENTIFICATION (Class) SOURCE <ul style="list-style-type: none"> Image Processing Software
GROUP_APPLICABILITY_FLAG	Specifies whether a group of keywords are valid values. It is present in a Group only when information is received from telemetry.	string		0 = "FALSE" 1 = "TRUE"	LOCATION <ul style="list-style-type: none"> Group Dependent: <ol style="list-style-type: none"> IMAGE_REQUEST_PARMs (Group) THUMBNAIl_REQUEST_PARMs (Group)

Keyword Name	Definition	Type	Units	Valid Values	<ul style="list-style-type: none"> • Location in PDS Label • Source
					<ul style="list-style-type: none"> c) COLUMN_SUM_REQUEST_PARMS (Group) d) ROW_SUM_REQUEST_PARMS (Group) e) HISTOGRAM_REQUEST_PARMS (Group) f) REFERENCE_PIXEL_REQUEST_PARMS (Group) g) SUN_FIND_REQUEST_PARMS (Group) h) SUBFRAME_REQUEST_PARMS (Group) <p>SOURCE</p> <ul style="list-style-type: none"> • Group Dependent, Table Lookup: <ul style="list-style-type: none"> a) IDPH:ImgParams:image b) IDPH:ImgParams:thumbnail c) IDPH:ImgParams:colsums d) IDPH:ImgParams:rowsums e) IDPH:ImgParams:histogram f) IDPH:ImgParams:ref g) IDPH:ImgParams:sun h) IDPH:ImgParams:subframe
HEADER_TYPE	<p>Specifies a specific type of header data structure. For example: FITS, VICAR.</p> <p>Note: In the PDS, HEADER_TYPE is used to indicate non-PDS headers.</p>	string(12)		"VICAR2"	<p>LOCATION</p> <ul style="list-style-type: none"> • IMAGE_HEADER (Object) <p>SOURCE</p> <ul style="list-style-type: none"> • Static Value
^IMAGE	<p>Specifies a pointer to the IMAGE object. See chapter 14 of the PDS Standards Reference for more information on pointer usage.</p>	NULL			<p>LOCATION</p> <ul style="list-style-type: none"> • POINTERS <p>SOURCE</p> <ul style="list-style-type: none"> • Calculation
^IMAGE_HEADER	<p>Specifies a pointer to the IMAGE_HEADER object. See chapter 14 of the PDS Standards Reference for more information on pointer usage.</p>	NULL			<p>LOCATION</p> <ul style="list-style-type: none"> • POINTERS <p>SOURCE</p> <ul style="list-style-type: none"> • Calculation
IMAGE_ID	<p>Specifies an image and typically consists of a sequence of characters representing 1) a routinely occurring measure, such as revolution number, 2) a letter identifying the spacecraft, target, or camera, and 3) a representation of a count within the measure, such as picture number within a given revolution.</p> <p>Note: See the Imaging FDD for more</p>	string(30)			<p>LOCATION</p> <ul style="list-style-type: none"> • IDENTIFICATION (Class) <p>SOURCE</p> <ul style="list-style-type: none"> • IDPH:ImgParams:imagid

Keyword Name	Definition	Type	Units	Valid Values	<ul style="list-style-type: none"> Location in PDS Label Source
	<p>detailed definition.</p> <p>Example: Mariner 9 - LevanthalIdentifier - (orbit, camera, pic #, total # of pics in orbit) Viking Orbiter - (orbit #, sc, pic # (FSC/16)), Viking Lander - (sc, camera, mars doy, diode (filter), pic # for that day), Voyager - (pic # for encounter, FDS for cruise)</p>				
IMAGE_TYPE	<p>Specifies the type of image acquired. This may be used to describe characteristics that differentiate one group of images from another such as the nature of the data in the image file, the purpose for which the image was acquired, or the way in which it was acquired.</p> <p>This element is very similar to the older image_observation_type element, but is designed to resolve ambiguities in cases where missions utilize a naming convention for both specific images and more general observations, which consist of multiple images. In those cases, the latter may be described by the observation_type element.</p>	string(15)		0, 1, 9 = "REGULAR" 2, 3, 11 = "THUMBNAIL" 4, 5, 12 = "REF_PIXELS" 6 = "HISTOGRAM" 7 = "ROW_SUM" 8 = "COL_SUM"	<p>LOCATION</p> <ul style="list-style-type: none"> IDENTIFICATION (Class) <p>SOURCE</p> <ul style="list-style-type: none"> Table Lookup: <ul style="list-style-type: none"> CCSDS:UPTH:APID:SubType
INPUT_IMAGE	<p>Specifies a list of the PRODUCT_IDs of images used to generate this RDR.</p> <p>NOTE: For SOAS calibrated images, this keyword will contain the corresponding raw EDR image. For SOAS mosaic products, this keyword will contain the list of EDR and/or RDR images used to generate the mosaic.</p>	string array			<p>LOCATION</p> <ul style="list-style-type: none"> DERIVED_IMAGE_PARMS <p>SOURCE</p> <ul style="list-style-type: none"> Image Processing Software
INPUT_IMAGE_WAVELENGTH	<p>Specifies the effective wavelength of the corresponding images listed in INPUT_IMAGE.</p>	integer array			<p>LOCATION</p> <ul style="list-style-type: none"> DERIVED_IMAGE_PARMS <p>SOURCE</p> <ul style="list-style-type: none"> Image Processing Software
INSTRUMENT_AZIMUTH	<p>Specifies the value for an instrument's rotation in the horizontal direction. It is usually measured from some kind of low hard stop. Although it may be used for any instrument where it makes sense, it is primarily intended for use in surface-based instruments that measure pointing in terms of azimuth and elevation.</p>	float	deg (<deg> unit tag required)		<p>LOCATION</p> <ul style="list-style-type: none"> ROVER_DERIVED_GEOMETRY_PARMS (Group) SITE_DERIVED_GEOMETRY_PARMS (Group) <p>SOURCE</p> <ul style="list-style-type: none"> Calculation

Keyword Name	Definition	Type	Units	Valid Values	<ul style="list-style-type: none"> Location in PDS Label Source
	<p>When in a DERIVED_GEOMETRY group, defines the azimuth (horizontal rotation) at which the instrument is pointed. This value is expressed using the coordinate system referred to by REFERENCE_COORD_SYSTEM_NAME and REFERENCE_COORD_SYSTEM_INDEX contained within the same group.</p> <p>The interpretation of exactly what part of the instrument is being pointed is mission-specific. It could be the boresight, the camera head direction, the CAHV camera model A vector direction, or any of a number of other things.</p> <p>For MER, the interpretation is the azimuth/elevation of the PMA head frame.</p> <p>As such, for multimission use this value should be used mostly as an approximation, e.g. identifying scenes which might contain a given object.</p>				
INSTRUMENT_BAND_ID	Specifies an array of strings identifying the instrument represented by the corresponding band in the image. The first entry in the array identifies the instrument for the first band, the second entry for the second band, etc. See also CONFIGURATION_BAND_ID.	string array[16]		"MI", "RAT", "MB", "APXS"	<p>LOCATION</p> <ul style="list-style-type: none"> DERIVED_IMAGE_PARAMS (Group) <p>SOURCE</p> <ul style="list-style-type: none"> Static value
INSTRUMENT_BORESIGHT_ID	Specifies the IVP (Inertial Vector Propagation) ID or boresight ID of the reference instrument used to designate commanded pointing.	string		21 = "CAMERA_BAR" 22 = "LEFT_PANCAM" 23 = "RIGHT_PANCAM" 24 = "LEFT_NAVCAM" 25 = "RIGHT_NAVCAM" 26 = "MINI_TES"	<p>LOCATION</p> <ul style="list-style-type: none"> OBSERVATION_REQUEST_PARAMS (Group) <p>SOURCE</p> <ul style="list-style-type: none"> Table Lookup: <ul style="list-style-type: none"> IDPH:ImgParams:pma_arg
INSTRUMENT_COORDINATE	Specifies an array of coordinate parameters.	double array[3]	<ul style="list-style-type: none"> radians for frame indices 1,2,4,8 (<rad> unit tag required) 	Also, 0 = "N/A"	<p>LOCATION</p> <ul style="list-style-type: none"> OBSERVATION_REQUEST_PARAMS (Group) <p>SOURCE</p> <ul style="list-style-type: none"> IDPH:ImgParams:pma_coord[3]
	<p>For MER, the parameters will be a set of azimuth and elevation values (radians) or a set of xyz position parameters (m). If the INSTRUMENT_COORDINATE_ID is an IVP, these values are ignored.</p>				

Keyword Name	Definition	Type	Units	Valid Values	<ul style="list-style-type: none"> Location in PDS Label Source
	<p>The units can be identified in the Units column by applying the following indices for the frames defined in keyword INSTRUMENT_COORDINATE_ID:</p> <p>0 = "NONE" 1 = "MAST AZEL" 2 = "RVR BODY AZEL" 3 = "RVR BODY 3DPNT" 4 = "LL AZEL" 5 = "LL 3DPNT" 6 = "SITE 3DPNT" 7 = "IVP OBJECT" 8 = "MAST RELATIVE AZEL"</p>		<ul style="list-style-type: none"> meters for frame indices 3,5,6 (<m> unit tag required) 		
INSTRUMENT_COORDINATE_ID	<p>Specifies the frame in which the INSTRUMENT_COORDINATE values are given.</p>	string		0 = "NONE" 1 = "MAST AZEL" 2 = "RVR BODY AZEL" 3 = "RVR BODY 3DPNT" 4 = "LL AZEL" 5 = "LL 3DPNT" 6 = "SITE 3DPNT" 7 = "IVP OBJECT" 8 = "MAST RELATIVE AZEL"	<p>LOCATION</p> <ul style="list-style-type: none"> OBSERVATION_REQUEST_PARMS (Group) <p>SOURCE</p> <ul style="list-style-type: none"> Table Lookup: <ul style="list-style-type: none"> IDPH:ImgParams:pma_coord_id
INSTRUMENT_ELEVATION	<p>Specifies a value for an instrument's rotation in the vertical direction. It is usually measured from some kind of low hard stop. Although it may be used for any instrument where it makes sense, it is primarily intended for use in surface-based instruments that measure pointing in terms of azimuth and elevation.</p> <p>When in a DERIVED_GEOMETRY group, defines the elevation (vertical rotation) at which the instrument is pointed. This value is expressed using the coordinate system referred to by REFERENCE_COORD_SYSTEM_NAME and REFERENCE_COORD_SYSTEM_INDEX contained within the same group.</p> <p>The interpretation of exactly what part of the instrument is being pointed is mission-specific. It could be the boresight, the camera head direction, the CAHV camera model A vector direction, or any of a</p>	float	deg (<deg> unit tag required)		<p>LOCATION</p> <ul style="list-style-type: none"> ROVER_DERIVED_GEOMETRY_PARMS (Group) SITE_DERIVED_GEOMETRY_PARMS (Group) <p>SOURCE</p> <ul style="list-style-type: none"> Calculation

Keyword Name	Definition	Type	Units	Valid Values	<ul style="list-style-type: none"> Location in PDS Label Source 										
	<p>number of other things.</p> <p>For MER, the interpretation is the azimuth/elevation of the PMA head frame.</p> <p>As such, for multimission use this value should be used mostly as an approximation, e.g. identifying scenes which might contain a given object.</p>														
INSTRUMENT_HOST_ID	<p>Specifies a unique identifier for the host where an instrument is located. This host can be either a spacecraft or an earth base (e.g., and observatory or laboratory on the earth). Thus, INSTRUMENT_HOST_ID can contain values which are either SPACECRAFT_ID values or EARTH_BASE_ID values.</p>	string array		<table border="1"> <thead> <tr> <th>SCID</th> <th>Keyword Value</th> </tr> </thead> <tbody> <tr> <td>252</td> <td>"SIM1"</td> </tr> <tr> <td>253</td> <td>"MER1"</td> </tr> <tr> <td>254</td> <td>"MER2"</td> </tr> <tr> <td>255</td> <td>"SIM2"</td> </tr> </tbody> </table>	SCID	Keyword Value	252	"SIM1"	253	"MER1"	254	"MER2"	255	"SIM2"	<p>LOCATION</p> <ul style="list-style-type: none"> IDENTIFICATION (Class) <p>SOURCE</p> <ul style="list-style-type: none"> Table Lookup: <ul style="list-style-type: none"> CHDO_82:scft_id
SCID	Keyword Value														
252	"SIM1"														
253	"MER1"														
254	"MER2"														
255	"SIM2"														
INSTRUMENT_HOST_NAME	<p>Specifies the full name of the host on which an instrument is based. This host can be either a spacecraft or an earth base. Thus, the INSTRUMENT_HOST_NAME element can contain values which are either SPACECRAFT_NAME values or EARTH_BASE_NAME values.</p> <p>Note that mosaics may contain more than one value in an array.</p>	string array		<p>"MARS EXPLORATION ROVER 1", "MARS EXPLORATION ROVER 2", "SIMULATED MARS EXPLORATION ROVER 1", "SIMULATED MARS EXPLORATION ROVER 2"</p>	<p>LOCATION</p> <ul style="list-style-type: none"> IDENTIFICATION (Class) <p>SOURCE</p> <ul style="list-style-type: none"> Table Lookup: <ul style="list-style-type: none"> CHDO_82:scft_id 										
INSTRUMENT_ID	<p>Specifies an abbreviated name or acronym which identifies an instrument.</p> <p>Note: INSTRUMENT_ID is not a unique identifier for a given instrument. Note also that the associated INSTRUMENT_NAME element provides the full name of the instrument.</p> <p>Example values: IRTM (for Viking Infrared Thermal Mapper), PWS (for plasma wave spectrometer).</p>	string array		<p>0 = "NONE" 21 = "PANCAM_LEFT" 22 = "PANCAM_RIGHT" 23 = "NAVCAM_LEFT" 24 = "NAVCAM_RIGHT" 25 = "FRONT_HAZCAM_LEFT" 26 = "FRONT_HAZCAM_RIGHT" 27 = "REAR_HAZCAM_LEFT" 28 = "REAR_HAZCAM_RIGHT" 29 = "MI" 30 = "DESCAM"</p>	<p>LOCATION</p> <ul style="list-style-type: none"> IDENTIFICATION (Class) <p>SOURCE</p> <ul style="list-style-type: none"> Table Lookup: <ul style="list-style-type: none"> CCSDS:Primary:APID 										
INSTRUMENT_IDLE_TIMEOUT	<p>Specifies the amount of time in seconds the instrument may be idle before powering off the instrument.</p>	integer	seconds (<s> unit tag required)	"0" to "4294967295"	<p>LOCATION</p> <ul style="list-style-type: none"> OBSERVATION_REQUEST_PARMS (Group) <p>SOURCE</p> <ul style="list-style-type: none"> IDPH:ImgParams:power_timeout 										

Keyword Name	Definition	Type	Units	Valid Values	<ul style="list-style-type: none"> Location in PDS Label Source
INSTRUMENT_MODE_ID	Specifies an instrument-dependent designation of operating mode. This may be simply a number, letter or code, or a word such as 'normal', 'full resolution', 'near encounter', or 'fixed grating'.	string(20)		"FULL_FRAME", "WINDOWED_FRAME", "4X1SUMMATION_FRAME", "FIXED_PATTERN_FRAME"	<p>LOCATION</p> <ul style="list-style-type: none"> Group Dependent: <ol style="list-style-type: none"> INSTRUMENT_STATE_PARAMS (Group) GROUND_SUPPORT_EQUIPMENT (Group) <p>SOURCE</p> <ul style="list-style-type: none"> Group Dependent: <ol style="list-style-type: none"> Calculation: <ul style="list-style-type: none"> IDPH:ImgParams:resolution IDPH:ImgTImHdr:subframe IDPH:exposure <p>NOTES: If resolution=2 or 3 (contains HW), then 4X1SUMMATION_FRAME. If subframe > 0 (TRUE) then WINDOWED_FRAME. If exposure=3 (TEST_MODE), then FIXED_PATTERN_FRAME, else FULL_FRAME.</p> <p>b) GSE Software</p>
INSTRUMENT_NAME	Specifies the full name of an instrument. Note: that the associated instrument_id element provides an abbreviated name or acronym for the instrument. Example values: FLUXGATE MAGNETOMETER, NEAR_INFRARED MAPPING SPECTROMETER.	string array		0 = "NONE" 21 = " PANORAMIC CAMERA LEFT" 22 = "PANORAMIC CAMERA RIGHT" 23 = "NAVIGATION CAMERA LEFT" 24 = "NAVIGATION CAMERA RIGHT" 25 = "FRONT HAZARD AVOIDANCE CAMERA LEFT" 26 = "FRONT HAZARD AVOIDANCE CAMERA RIGHT" 27 = "REAR HAZARD AVOIDANCE CAMERA LEFT" 28 = "REAR HAZARD AVOIDANCE CAMERA RIGHT" 29 = "MICROSCOPIC IMAGER" 30 = "ENTRY DESCENT LANDING CAMERA"	<p>LOCATION</p> <ul style="list-style-type: none"> IDENTIFICATION (Class) <p>SOURCE</p> <ul style="list-style-type: none"> Table Lookup: <ul style="list-style-type: none"> CCSDS:Primary:APID

Keyword Name	Definition	Type	Units	Valid Values	<ul style="list-style-type: none"> Location in PDS Label Source
INSTRUMENT_SERIAL_NUMBER	Specifies the manufacturer's serial number assigned to an instrument. This number may be used to uniquely identify a particular instrument for tracing its components or determining its calibration history, for example.	integer		"1" to "255"	LOCATION <ul style="list-style-type: none"> IDENTIFICATION (Class) SOURCE <ul style="list-style-type: none"> IDPH:ImgTImHdr:serial_no
INSTRUMENT_TEMPERATURE	Specifies the temperature, in degrees Celcius, of an instrument or some part of an instrument. Note that this may be an array of multiple values for temperatures on different parts of the instrument. (Example: CCD array and sensor head)	float array	deg C (<degC> unit tag required)		LOCATION <ul style="list-style-type: none"> INSTRUMENT_STATE_PARMS (Group) SOURCE <ul style="list-style-type: none"> Calculation: <ul style="list-style-type: none"> IDPH:ImgTImHdr:temp[9]
INSTRUMENT_TEMPERATURE_NAME	Specifies an array of the formal names identifying each of the values used in INSTRUMENT_TEMPERATURE.	string array[9]		("FRONT HAZ ELECTRONICS", "REAR HAZ ELECTRONICS", "LEFT PAN ELECTRONICS", "LEFT PAN CCD", "RIGHT PAN CCD", "LEFT NAV CCD", "MI CCD", "MI ELECTRONICS", "EDL CCD")	LOCATION <ul style="list-style-type: none"> INSTRUMENT_STATE_PARMS (Group) SOURCE <ul style="list-style-type: none"> Static Value
INSTRUMENT_TYPE	Specifies the type of an instrument. Example values: POLARIMETER, RADIOMETER, REFLECTANCE SPECTROMETER, VIDICON CAMERA. Note that mosaics may contain more than one value in an array.	string array		"IMAGING CAMERA"	LOCATION <ul style="list-style-type: none"> IDENTIFICATION (Class) SOURCE <ul style="list-style-type: none"> Static Value
INSTRUMENT_VERSION_ID	Specifies the model of an instrument used to obtain data. For example, this keyword could be used to distinguish between an engineering model of a camera used to acquire test data, and a flight model of a camera used to acquire science data during a mission.	string(8)		<u>Serial Number is 1-9</u> "BB" <u>Serial Number is 10-100</u> "EM" <u>Serial Number > 100</u> "FM"	LOCATION <ul style="list-style-type: none"> IDENTIFICATION (Class) SOURCE <ul style="list-style-type: none"> Table Lookup: <ul style="list-style-type: none"> IDPH:ImgTImHdr:serial_no
INST_CMPRS_DESC	Specifies a textual description of the type of data compression used by an instrument onboard a spacecraft before the data was transmitted to Earth. This should include a description of the compression algorithm or a reference to a published paper where the algorithm is described. For the MER mission, ICER compression can be either "Lossless" or "Lossy". For the	string		<u>ICER Compression</u> "Lossless compression algorithm developed at JPL", "Lossy compression algorithm developed at JPL" <u>LOCO Compression</u> "Lossless compression algorithm developed at JPL"	LOCATION <ul style="list-style-type: none"> COMPRESSION_PARMS (Group) SOURCE <ul style="list-style-type: none"> CCSDS:UPTH:APID SubType

Keyword Name	Definition	Type	Units	Valid Values	<ul style="list-style-type: none"> Location in PDS Label Source
	MER mission, LOCO compression is assumed to always be "Lossless".			<u>Additional value for Location "b"</u> Uncompressed = "N/A"	
INST_CMPRS_FILTER	Specifies the wavelet filter used in the ICER or LOCO compression and decompression algorithm.	string		0 = "A" 1 = "B" 2 = "C" 3 = "D" 4 = "E" 5 = "F" 6 = "Q" <u>Additional value for Location "d"</u> Uncompressed or LOCO = "N/A"	LOCATION <ul style="list-style-type: none"> Group Dependent: <ol style="list-style-type: none"> IMAGE_REQUEST_PARAMS (Group) REFERENCE_PIXEL_REQUEST_PARAMS (Group) THUMBNAI_REQUEST_PARAMS (Group) COMPRESSION_PARAMS (Group) SOURCE <ul style="list-style-type: none"> Group Dependent, Table Lookup: <ol style="list-style-type: none"> IDPH:ImgParams:comp.wavelet_filter IDPH:ImgParams:ref_comp.wavelet_filter IDPH:ImgParams:thumb_comp.wavelet_filter Extracted from ICER segment
INST_CMPRS_MODE	Specifies the method used for on-board compression of data. For the MER mission, ICER compression can be either "Lossless" or "Lossy". For the MER mission, LOCO compression is assumed to always be "Lossless". Note: The INST_CMPRS_NAME element provides the full name of an INST_CMPRS_MODE.	integer		"0" = None "1" = Lossless "2" = Lossy	LOCATION <ul style="list-style-type: none"> Group Dependent: <ol style="list-style-type: none"> IMAGE_REQUEST_PARAMS (Group) REFERENCE_PIXEL_REQUEST_PARAMS (Group) THUMBNAI_REQUEST_PARAMS (Group) COMPRESSION_PARAMS (Group) SOURCE <ul style="list-style-type: none"> Group Dependent: <ol style="list-style-type: none"> IDPH:ImgParams:comp.compress IDPH:ImgParams:ref_comp.compress IDPH:ImgParams:thumb_comp.compress CCSDS:UPTH:APID SubType
INST_CMPRS_NAME	Specifies the type of on-board compression used for data storage and transmission. For the MER mission, ICER compression can be either "Lossless" or "Lossy". For the MER mission, LOCO compression is assumed to always be "Lossless". Note: The INST_CMPRS_MODE element provides an abbreviated identifier for the INST_CMPRS_NAME.	string		"ICER ADAPTIVE VARIABLE-LENGTH CODING (ICER)", "LOW-COMPLEXITY LOSSLESS COMPRESSION (LOCO)" Uncompressed = "N/A"	LOCATION <ul style="list-style-type: none"> COMPRESSION_PARAMS (Group) SOURCE <ul style="list-style-type: none"> Table Lookup: <ul style="list-style-type: none"> CCSDS:UPTH:APID SubType
INST_CMPRS_QUALITY	Specifies a JPEG- or ICER-specific variable which identifies the resultant or targeted image quality index for on-board data compression.	integer		"0" to "18" <u>Additional value for Location "d"</u> Uncompressed = "N/A"	LOCATION <ul style="list-style-type: none"> Group Dependent: <ol style="list-style-type: none"> IMAGE_REQUEST_PARAMS (Group) REFERENCE_PIXEL_REQUEST_PARAMS

Keyword Name	Definition	Type	Units	Valid Values	<ul style="list-style-type: none"> Location in PDS Label Source
					<ul style="list-style-type: none"> (Group) c) THUMBNAIL_REQUEST_PARMS (Group) d) COMPRESSION_PARMS (Group) <p>SOURCE</p> <ul style="list-style-type: none"> Group Dependent: <ul style="list-style-type: none"> a) IDPH:ImgParams:comp.minloss b) IDPH:ImgParams:ref_comp.minloss c) IDPH:ImgParams:thumb_comp.minloss d) Calculated
INST_CMPRS_RATE	Specifies the average number of bits needed to represent a pixel for an on-board compressed image.	float		<p>"1" to "12"</p> <p><u>Additional value for Location "d"</u> Uncompressed = "N/A"</p>	<p>LOCATION</p> <ul style="list-style-type: none"> Group Dependent: <ul style="list-style-type: none"> a) IMAGE_REQUEST_PARMS (Group) b) REFERENCE_PIXEL_REQUEST_PARMS (Group) c) THUMBNAIL_REQUEST_PARMS (Group) d) COMPRESSION_PARMS (Group) <p>SOURCE</p> <ul style="list-style-type: none"> Group Dependent: <ul style="list-style-type: none"> a) IDPH:ImgParams:comp.bpp b) IDPH:ImgParams:ref_comp.bpp c) IDPH:ImgParams:thumb_comp.bpp d) Calculated (bits_in/pixels_out)
INST_CMPRS_RATIO	Specifies the ratio of the size, in bytes, of the original uncompressed data file to its compressed form.	float		Uncompressed = "N/A"	<p>LOCATION</p> <ul style="list-style-type: none"> COMPRESSION_PARMS (Group) <p>SOURCE</p> <ul style="list-style-type: none"> Calculation: <ul style="list-style-type: none"> - Sum of the size of ICER uncompressed image over the compressed segments area (bits_out/bits_in)
INST_CMPRS_SEGMENTS	Specifies the number of segments into which the image was partitioned for the error containment purposes. For ICER compression, the data within each segment is compressed independently, so that data loss across segments is compartmentalized or contained across segments.	integer		<p>"1" to "32"</p> <p><u>Additional value for Location "d"</u> Uncompressed = "N/A"</p>	<p>LOCATION</p> <ul style="list-style-type: none"> Group Dependent: <ul style="list-style-type: none"> a) IMAGE_REQUEST_PARMS (Group) b) REFERENCE_PIXEL_REQUEST_PARMS (Group) c) THUMBNAIL_REQUEST_PARMS (Group) d) COMPRESSION_PARMS (Group) <p>SOURCE</p> <ul style="list-style-type: none"> Group Dependent: <ul style="list-style-type: none"> a) IDPH:ImgParams:comp.n_segs b) IDPH:ImgParams:ref_comp.n_segs c) IDPH:ImgParams:thumb_comp.n_segs d) Extracted from ICER segment

Keyword Name	Definition	Type	Units	Valid Values	<ul style="list-style-type: none"> Location in PDS Label Source
INST_CMPRS_SEGMENT_QUALITY	Specifies the quality level for each ICER segment.	float array		Uncompressed or ICER = "N/A"	LOCATION <ul style="list-style-type: none"> COMPRESSION_PARMS (Group) SOURCE <ul style="list-style-type: none"> Extracted from ICER segment
INST_CMPRS_SEGMENT_STATUS	Specifies a bit mask which provides the status of decoding the nth segment.	string		Uncompressed = "N/A"	LOCATION <ul style="list-style-type: none"> COMPRESSION_PARMS (Group) SOURCE <ul style="list-style-type: none"> Returned from ICER decompression routine
INST_CMPRS_SEG_FIRST_LINE	Specifies an array of values which each nth element identifies the line within a source image that corresponds to the first line the nth compression segment applies. Value of "-1" denotes the indeterminate case when decompressor cannot process the segment, or cannot determine seq_quality for a segment that it could decompress.	integer array		"-1" to "1024" Uncompressed = "N/A"	LOCATION <ul style="list-style-type: none"> COMPRESSION_PARMS (Group) SOURCE <ul style="list-style-type: none"> Extracted from ICER segment
INST_CMPRS_SEG_FIRST_LINE_SAMP	Specifies an array of values which each nth element identifies the line sample within a source image that corresponds to the first line sample the nth compression segment applies. Value of "-1" denotes the indeterminate case when decompressor cannot process the segment, or cannot determine seq_quality for a segment that it could decompress.	integer array		"-1" to "1024" Uncompressed = "N/A"	LOCATION <ul style="list-style-type: none"> COMPRESSION_PARMS (Group) SOURCE <ul style="list-style-type: none"> Extracted from ICER segment
INST_CMPRS_SEG_LINES	Specifies an array of elements in which the nth element identifies the total number of data instances along the vertical axis the nth compression segment defines. Value of "-1" denotes the indeterminate case when decompressor cannot process the segment, or cannot determine seq_quality for a segment that it could decompress.	integer array		"-1" to "1024" Uncompressed = "N/A"	LOCATION <ul style="list-style-type: none"> COMPRESSION_PARMS (Group) SOURCE <ul style="list-style-type: none"> Extracted from ICER segment
INST_CMPRS_SEG_MISSING_PIXELS	Specifies an array of elements in which the nth element identifies the total number missing pixels that the nth compression segment defines.	integer array		Uncompressed or ICER = "N/A"	LOCATION <ul style="list-style-type: none"> COMPRESSION_PARMS (Group) SOURCE

Keyword Name	Definition	Type	Units	Valid Values	<ul style="list-style-type: none"> Location in PDS Label Source
					<ul style="list-style-type: none"> Extracted from LOCO segment
INST_CMPRS_SEG_SAMPLES	<p>Specifies an array of elements in which the nth element identifies the total number of data instances along the horizontal axis the nth compression segment defines.</p> <p>Value of "-1" denotes the indeterminate case when decompressor cannot process the segment, or cannot determine seq_quality for a segment that it could decompress.</p>	integer array		<p>"-1" to "1024"</p> <p>Uncompressed = "N/A"</p>	<p>LOCATION</p> <ul style="list-style-type: none"> COMPRESSION_PARMS (Group) <p>SOURCE</p> <ul style="list-style-type: none"> Extracted from ICER segment
INST_DECOMP_STAGES	Specifies the number of stages of wavelet decompositions.	integer		<p>"1" to "6"</p> <p><u>Additional value for Location "d"</u> Uncompressed or LOCO = "N/A"</p>	<p>LOCATION</p> <ul style="list-style-type: none"> Group Dependent: <ul style="list-style-type: none"> a) IMAGE_REQUEST_PARMS (Group) b) REFERENCE_PIXEL_REQUEST_PARMS (Group) c) THUMBNAIL_REQUEST_PARMS (Group) d) COMPRESSION_PARMS (Group) <p>SOURCE</p> <ul style="list-style-type: none"> Group Dependent: <ul style="list-style-type: none"> a) IDPH:ImgParams:comp.n_decomps b) IDPH:ImgParams:ref_comp.n_decomps c) IDPH:ImgParams:thumb_comp.n_decomps d) Extracted from ICER segment
INTERCHANGE_FORMAT	Specifies the manner in which data items are stored.	string(6)		"ASCII", "BINARY"	<p>LOCATION</p> <ul style="list-style-type: none"> Group Dependent: <ul style="list-style-type: none"> a) IMAGE_HEADER (Object) b) IMAGE (Object) <p>SOURCE</p> <ul style="list-style-type: none"> Static Value
INVALID_CONSTANT	<p>Specifies the value used when the received data are out of the legitimate range of values.</p> <p>For MER, the value should be 0.0 for most OPGS-generated products, with the exception of Surface Normal and Surface Roughness RDRs. For SOAS-generated products, the value may be different.</p>	float or float array		<p><u>Most OPGS-gen'd Products</u> "0.0"</p> <p><u>XYZ</u> "(0.0, 0.0)"</p> <p><u>Surface Normal (UVW)</u> "(0.0, 0.0)"</p> <p><u>Surface Roughness</u> Value from parameter, default is "0.1"</p>	<p>LOCATION</p> <ul style="list-style-type: none"> IMAGE (Object) <p>SOURCE</p> <ul style="list-style-type: none"> Static Value
INVERSE_LUT_FILE	Specifies the name of the inverse-lookup-	string			LOCATION

Keyword Name	Definition	Type	Units	Valid Values	<ul style="list-style-type: none"> Location in PDS Label Source
	<p>table file used in generating the RDR.</p> <p>NOTE: If the raw EDR is already in 12-bit format (has not been LUT-ed) then no inverse-LUT file is used and this keyword is not included in the PDS label.</p>				<ul style="list-style-type: none"> DERIVED_IMAGE_PARAMS (Group) <p>SOURCE</p> <ul style="list-style-type: none"> Image Processing Software
LABEL_RECORDS	<p>Specifies the number of physical file records that contain only (PDS) label information. The number of data records in a file is determined by subtracting the value of label_records from the value of file_records.</p> <p>Note: In the PDS, the use of label_records along with other file-related data elements is fully described in the Standards Reference.</p>	integer		"0" to n	<p>LOCATION</p> <ul style="list-style-type: none"> FILE (Class) <p>SOURCE</p> <ul style="list-style-type: none"> Calculated by size of PDS label.
LIGHT_SOURCE_DISTANCE	Specifies the distance from the target body center and secondary light source center.	float	meters (<m> unit tag required)		<p>LOCATION</p> <ul style="list-style-type: none"> GROUND_SUPPORT_EQUIPMENT (Group) <p>SOURCE</p> <ul style="list-style-type: none"> GSE software
LIGHT_SOURCE_NAME	Specifies the name of the light source used in observations when it is not the Sun.	string			<p>LOCATION</p> <ul style="list-style-type: none"> GROUND_SUPPORT_EQUIPMENT (Group) <p>SOURCE</p> <ul style="list-style-type: none"> GSE software
LIGHT_SOURCE_TYPE	Specifies the source of illumination used in instrument calibration.	string			<p>LOCATION</p> <ul style="list-style-type: none"> GROUND_SUPPORT_EQUIPMENT (Group) <p>SOURCE</p> <ul style="list-style-type: none"> GSE software
LINES	<p>Specifies the total number of data instances along the vertical axis of an image.</p> <p>Note: In PDS label convention, the number of lines is stored in a 32-bit integer field. The minimum value of 0 indicates no data received.</p>	integer		"1" to "1024"	<p>LOCATION</p> <ul style="list-style-type: none"> Group Dependent: <ul style="list-style-type: none"> a) THUMBNAIL_REQUEST_PARAMS(Group) b) SUBFRAME_REQUEST_PARAMS (Group) c) SUN_FIND_REQUEST_PARAMS (Group) d) IMAGE (Object) <p>SOURCE</p> <ul style="list-style-type: none"> Group Dependent: <ul style="list-style-type: none"> a) IDPH:ImgParams:thumb_rows b) IDPH:ImgParams:sub_rows c) IDPH:ImgParams:sub_sun_rows d) IDPH:ImgTImHdr:rows

Keyword Name	Definition	Type	Units	Valid Values	<ul style="list-style-type: none"> Location in PDS Label Source
LINE_CAMERA_MODEL_OFFSET	Specifies the location of the image origin with respect to the camera model's origin. For CAHV/CAHVOR models, this origin is not the center of the camera, but is the upper-left corner of the "standard"-size image, which is encoded in the CAHV vectors. (MIPL Projection - Perspective)	float	pixel (<pixel> unit tag required)		LOCATION <ul style="list-style-type: none"> SURFACE_PROJECTION_PARMS (Group) SOURCE <ul style="list-style-type: none"> Image Processing Software
LINE_PREFIX_BYTES	Specifies the number of non-image bytes at the beginning of each line. The value must represent an integral number of bytes. For MER, only applies to testing using Ground Support Equipment (see Appendix A).	integer			LOCATION <ul style="list-style-type: none"> IMAGE (Object) SOURCE <ul style="list-style-type: none"> Calculation: <ul style="list-style-type: none"> - GSE Software
LINE_PREFIX_MEAN	Specifies the average of the DN values of the LINE_PREFIX_BYTES. For MER, only applies to testing using Ground Support Equipment (see Appendix A).	float			LOCATION <ul style="list-style-type: none"> IMAGE (Object) SOURCE <ul style="list-style-type: none"> Calculation: <ul style="list-style-type: none"> - GSE Software
LINE_PROJECTION_OFFSET	Specifies the line coordinate of the location in the image of the "special" point of the mosaic. For Polar projections, this is the nadir of the polar projection. For Vertical and Orthographic projections, this is the origin of the projected coordinate system grid (i.e., X=0.0, Y=0.0). Not applicable to other projections.	float	pixel (<pixel> unit tag required)		LOCATION <ul style="list-style-type: none"> SURFACE_PROJECTION_PARMS (Group) SOURCE <ul style="list-style-type: none"> Image Processing Software
LINE_SAMPLES	Specifies the total number of data instances along the horizontal axis of an image.	integer		"1" to "1024"	LOCATION <ul style="list-style-type: none"> Group Dependent: <ol style="list-style-type: none"> THUMBNAIL_REQUEST_PARMS (Group) SUBFRAME_REQUEST_PARMS (Group) SUN_FIND_REQUEST_PARMS (Group) IMAGE (Object) SOURCE <ul style="list-style-type: none"> Group Dependent: <ol style="list-style-type: none"> IDPH:ImgParams:thumb_cols IDPH:ImgParams:sub_cols IDPH:ImgParams:sub_sun_cols IDPH:ImgTImHdr:cols
LINE_SUFFIX_BYTES	Specifies the number of non-image bytes at the end of each line. This value must be an integral number of bytes.	integer			LOCATION <ul style="list-style-type: none"> IMAGE (Object)

Keyword Name	Definition	Type	Units	Valid Values	<ul style="list-style-type: none"> Location in PDS Label Source
	For MER, only applies to testing using Ground Support Equipment (see Appendix A).				SOURCE <ul style="list-style-type: none"> Calculation: <ul style="list-style-type: none"> - GSE Software
LINE_SUFFIX_MEAN	<p>Specifies the average of the DN values of the LINE_SUFFIX_BYTES.</p> <p>For MER, only applies to testing using Ground Support Equipment (see Appendix A).</p>	float			LOCATION <ul style="list-style-type: none"> IMAGE (Object) SOURCE <ul style="list-style-type: none"> Calculation: <ul style="list-style-type: none"> - GSE Software
LOCAL_TRUE_SOLAR_TIME	<p>Specifies the local true solar time, or LTST. It is one of two types of solar time used to express the time of day at a point on the surface of a planetary body. LTST is measured relative to the true position of the Sun as seen from a point on the planet's surface.</p> <p>The coordinate system used to define LTST has its origin at the center of the planet. Its Z-axis is the north pole vector (or spin axis) of the planet. The X-axis is chosen to point in the direction of the vernal equinox of the planet's orbit. (The vernal or autumnal equinox vectors are found by searching the planetary ephemeris for those times when the vector from the planet's center to the Sun is perpendicular to the planet's north pole vector. The vernal equinox is the time when the Sun appears to rise above the planet's equator.)</p> <p>Positions of points in this frame can be expressed as a radius and areocentric 'right ascension' and 'declination' angles. The areocentric right ascension angle, or ARA, is measured positive eastward in the equatorial plane from the vernal equinox vector to the intersection of the meridian containing the point with the equator. Similarly, the areocentric declination is the angle between the equatorial plane and the vector to the point. LTST is a function of the difference between the ARAs of the vectors to the Sun and to the point on the planet's surface. Specifically,</p>	string(12)		NOTE: Value will be uncalibrated if SPICE kernels are unavailable.	LOCATION <ul style="list-style-type: none"> IDENTIFICATION (Class) SOURCE <ul style="list-style-type: none"> Calculation: <ul style="list-style-type: none"> - UPTH:DataValidityTime - SCLK Kernel - Landing-Site kernel - P Kernel

Keyword Name	Definition	Type	Units	Valid Values	<ul style="list-style-type: none"> • Location in PDS Label • Source
	<p> $LTST = (a(P) - a(TS)) * (24 / 360) + 12$ where, LTST = the local true solar time in true solar hours a(P) = ARA of the point on the planet's surface in deg a(TS) = ARA of the true sun in deg </p> <p> The conversion factor of 24/360 is applied to transform the angular measure in decimal degrees into hours-minutes-seconds of arc. This standard representation divides 360 degrees into 24 hours, each hour into 60 minutes, and each minute into 60 seconds of arc. The hours, minutes, and seconds of arc are called 'true solar' hours, minutes, and seconds when used to measure LTST. The constant offset of 12 hours is added to the difference in ARAs to place local noon (12:00:00 in hours, minutes, seconds) at the point where the Sun is directly overhead; at this time, the ARA of the true sun is the same as that of the surface point so that $a(P) - a(TS) = 0$. </p> <p> The use of 'true solar' time units can be extended to define a true solar day as 24 true solar hours. Due to the eccentricity of planetary orbits and the inclination of orbital planes to equatorial planes (obliquity), the Sun does not move at a uniform rate over the course of a planetary year. Consequently, the number of SI seconds in a true solar day, hour, minute or second is not constant. </p> <p>See also LOCAL_MEAN_SOLAR_TIME.</p> <p>This element replaces the older MPF_LOCAL_TIME, which should no longer be used.</p>				
MAGNET_ID	Specifies a magnet instrument that is visible in an image or observation.	string		"N/A", "CAPTURE", "FILTER", "SWEEP", "RAT", "UNK", "NULL"	<p>LOCATION</p> <ul style="list-style-type: none"> • IDENTIFICATION (Class) <p>SOURCE</p>

Keyword Name	Definition	Type	Units	Valid Values	<ul style="list-style-type: none"> Location in PDS Label Source
					<ul style="list-style-type: none"> Calculated via an algorithm using: <ul style="list-style-type: none"> IDPH:ImgTlmHdr:pma_final.azimuth IDPH:ImgTlmHdr:pma_final.elevation IDPH:ImgTlmHdr:idd_pos
MAP_PROJECTION_TYPE	<p>Specifies the type of projection characteristic of a given map.</p> <p>When in a SURFACE_PROJECTION group, defines the surface-based map projection used in the image.</p>	string		"CYLINDRICAL", "VERTICAL", "PERSPECTIVE", "POLAR", "ORTHOGRAPHIC", "CYLINDRICAL-PERSPECTIVE"	<p>LOCATION</p> <ul style="list-style-type: none"> SURFACE_PROJECTION_PARAMS (Group) <p>SOURCE</p> <ul style="list-style-type: none"> Image Processing Software
MAP_RESOLUTION	<p>Specifies the scale of a given map. Please refer to the definition for MAP_SCALE for a more complete definition.</p> <p>When in a SURFACE_PROJECTION group, defines the resolution of the map in pixels/degree. For CYLINDRICAL, this is constant throughout. For POLAR, this is for the Elevation (radial) direction only. For PERSPECTIVE and CYLINDRICAL-PERSPECTIVE, this is at the center of the output camera model. Not applicable to VERTICAL.</p> <p>Note: MAP_RESOLUTION and MAP_SCALE both define the scale of a map except that they are expressed in different units: MAP_RESOLUTION is in pixels/deg and MAP_SCALE is in meters/pixel.</p> <p>If two values are present, the first measures in the line direction while the second measures in the sample direction.</p>	float array[2]	pixels /deg (<pix/deg > unit tag required)		<p>LOCATION</p> <ul style="list-style-type: none"> SURFACE_PROJECTION_PARAMS (Group) <p>SOURCE</p> <ul style="list-style-type: none"> Image Processing Software
MAP_SCALE	<p>Specifies the scale of a given map. The scale is defined as the ratio of the actual distance between two points on the surface of the target body to the distance between the corresponding points on the map.</p> <p>MAP_SCALE references the scale of a map at a certain reference point or line. Certain map projections vary in scale throughout the map.</p>	float array[2]	m/pixel (<m/pixel > unit tag required)		<p>LOCATION</p> <ul style="list-style-type: none"> SURFACE_PROJECTION_PARAMS (Group) <p>SOURCE</p> <ul style="list-style-type: none"> Image Processing Software

Keyword Name	Definition	Type	Units	Valid Values	<ul style="list-style-type: none"> Location in PDS Label Source
	<p>When in a SURFACE_PROJECTION group, defines the scale of the map in meters/pixel. Applicable to VERTICAL and ORTHOGRAPHIC projections only.</p> <p>Note: MAP_RESOLUTION and MAP_SCALE both define the scale of a map except that they are expressed in different units: MAP_RESOLUTION is in pixels/deg and MAP_SCALE is in meters/pixel.</p> <p>If two values are present, the first measures in the line direction while the second measures in the sample direction.</p>				
MAXIMUM	Specifies the largest value occurring in a given instance of the data object. Note: For PDS applications -- because of the unconventional data type of this data element, the element should appear in labels only within an explicit object, i.e., anywhere between an 'OBJECT =' and an 'END_OBJECT'.	float			<p>LOCATION</p> <ul style="list-style-type: none"> IMAGE (Object) <p>SOURCE</p> <ul style="list-style-type: none"> Calculation
MAXIMUM_ELEVATION	<p>Specifies the elevation (as defined by the coordinate system) of the first line of the image.</p> <p>Applies to MIPL projections Cylindrical, Perspective and Cylindrical-Perspective.</p>	float	deg (<deg> unit tag required)		<p>LOCATION</p> <ul style="list-style-type: none"> SURFACE_PROJECTION_PARAMS (Group) <p>SOURCE</p> <ul style="list-style-type: none"> Image Processing Software
MAX_AUTO_EXPOS_ITERATION_COUNT	Specifies the maximum number of exposure iterations the instrument will perform in order to obtain the requested exposure when operating in an autonomous mode.	integer		"0" to "10"	<p>LOCATION</p> <ul style="list-style-type: none"> OBSERVATION_REQUEST_PARAMS (Group) <p>SOURCE</p> <ul style="list-style-type: none"> IDPH:ImgParams:exp_auto_iter
MEAN	Specifies the average of the DN values in the image array.	float			<p>LOCATION</p> <ul style="list-style-type: none"> IMAGE (Object) <p>SOURCE</p> <ul style="list-style-type: none"> Calculation
MEDIAN	Specifies the median value (middle value) occurring in a given instance of the data object. Because of the unconventional data type of this data element, the element should appear in labels only within an explicit object, i.e., anywhere between an	float			<p>LOCATION</p> <ul style="list-style-type: none"> IMAGE (Object) <p>SOURCE</p> <ul style="list-style-type: none"> Calculation

Keyword Name	Definition	Type	Units	Valid Values	<ul style="list-style-type: none"> • Location in PDS Label • Source
	'OBJECT =' and an 'END OBJECT'.				
MINIMUM	Specifies the smallest value occurring in a given instance of the data object. Note: For PDS and Mars Observer applications -- because of the unconventional data type of this data element, the element should appear in labels only within an explicit object, i.e., anywhere between an 'OBJECT =' and an 'END OBJECT'.	float			LOCATION <ul style="list-style-type: none"> • IMAGE (Object) SOURCE <ul style="list-style-type: none"> • Calculation
MINIMUM_ELEVATION	Specifies the elevation (as defined by the coordinate system) of the last line of the image for Cylindrical map projections. Applies to Cylindrical, Perspective and Cylindrical-Perspective projections.	float	deg (<deg> unit tag required)		LOCATION <ul style="list-style-type: none"> • SURFACE_PROJECTION_PARMS (Group) SOURCE <ul style="list-style-type: none"> • Calculation
MISSING_CONSTANT	Specifies the flag value used in the image to indicate that no science data are available for any given pixel. See the specific product definitions for standard values used for each product.	float or float array		"0.0" <u>XYZ</u> "(0.0, 0.0)" <u>Surface Normal (UVW)</u> "(0.0, 0.0)"	LOCATION <ul style="list-style-type: none"> • IMAGE (Object) SOURCE <ul style="list-style-type: none"> • Static Value
MISSION_NAME	Specifies a major planetary mission or project. A given planetary mission may be associated with one or more spacecraft. Note that mosaics may contain more than one value in an array.	string array		"MARS EXPLORATION ROVER"	LOCATION <ul style="list-style-type: none"> • IDENTIFICATION (Class) SOURCE <ul style="list-style-type: none"> • Static Value
MISSION_PHASE_NAME	Specifies the commonly-used identifier of a mission phase.	string(30)		"CRUISE", "PRIMARY MISSION", "EXTENDED MISSION", "EXTENDED EXTENDED MISSION", "ASSEMBLY TEST LAUNCH AND OPS 1", "ASSEMBLY TEST LAUNCH AND OPS 2", "SURFACE SYSTEM TESTBED 1", "SURFACE SYSTEM TESTBED LITE", "FLIGHT SOFTWARE TESTBED 1", "FLIGHT SOFTWARE TESTBED 2", "CRUISE/EDL TESTBED", "FIELD TEST 1", "FIELD TEST 2", "MARS YARD 1", "MARS YARD 2", "SURFACE OPS READINESS TEST 1",	LOCATION <ul style="list-style-type: none"> • IDENTIFICATION (Class) SOURCE <ul style="list-style-type: none"> • Operator Supplied Parameter

Keyword Name	Definition	Type	Units	Valid Values	<ul style="list-style-type: none"> Location in PDS Label Source
				"SURFACE OPS READINESS TEST 2", "SURFACE OPS READINESS TEST 3", "SURFACE OPS READINESS TEST 4/5", "SURFACE OPS READINESS TEST 6A", "SURFACE OPS READINESS TEST 6B", "SURFACE OPS READINESS TEST 7/9", "SURFACE OPS READINESS TEST 10"	<ul style="list-style-type: none"> Location in PDS Label Source
MODEL_COMPONENT_1	<p>Specifies a set of values representing the first component of a model. The significance (or meaning) of this array of values is indicated by the first value of the MODEL_COMPONENT_ID and/or MODEL_COMPONENT_NAME elements. The interpretation of the values themselves depends on the model but they commonly represent a vector, a set of polynomial coefficients, or a simple numeric parameter.</p> <p>For example, for a geometric camera model with a value of "CAHV" for MODEL_TYPE, the first value of the MODEL_COMPONENT_NAME data element is CENTER, meaning that the MODEL_COMPONENT_1 is a focal center vector. The three items in this vector provide X, Y, and Z coordinates of the focal point of the camera.</p> <p>The exact details about each model component vector are provided in MODEL_DESC.</p>	float array			<p>LOCATION</p> <ul style="list-style-type: none"> GEOMETRIC_CAMERA_MODEL (Group) <p>SOURCE</p> <ul style="list-style-type: none"> IDPH:ImgTImHdr:cmodel.c[3]
MODEL_COMPONENT_2	Specifies the value of the component of the MODEL_COMPONENT_ID for the second element.	float array			<p>LOCATION</p> <ul style="list-style-type: none"> GEOMETRIC_CAMERA_MODEL (Group) <p>SOURCE</p> <ul style="list-style-type: none"> IDPH:ImgTImHdr:cmodel.a[3]
MODEL_COMPONENT_3	Specifies the value of the component of the MODEL_COMPONENT_ID for the third element.	float array			<p>LOCATION</p> <ul style="list-style-type: none"> GEOMETRIC_CAMERA_MODEL (Group) <p>SOURCE</p> <ul style="list-style-type: none"> IDPH:ImgTImHdr:cmodel.h[3]

Keyword Name	Definition	Type	Units	Valid Values	<ul style="list-style-type: none"> Location in PDS Label Source
MODEL_COMPONENT_4	Specifies the value of the component of the MODEL_COMPONENT_ID for the fourth element.	float array			<p>LOCATION</p> <ul style="list-style-type: none"> GEOMETRIC_CAMERA_MODEL (Group) <p>SOURCE</p> <ul style="list-style-type: none"> IDPH:ImgTImHdr:cmodel.v[3]
MODEL_COMPONENT_5	Specifies the value of the component of the MODEL_COMPONENT_ID for the fifth element.	float array			<p>LOCATION</p> <ul style="list-style-type: none"> GEOMETRIC_CAMERA_MODEL (Group) <p>SOURCE</p> <ul style="list-style-type: none"> IDPH:ImgTImHdr:cmodel.o[3]
MODEL_COMPONENT_6	Specifies the value of the component of the MODEL_COMPONENT_ID for the sixth element.	float array			<p>LOCATION</p> <ul style="list-style-type: none"> GEOMETRIC_CAMERA_MODEL (Group) <p>SOURCE</p> <ul style="list-style-type: none"> IDPH:ImgTImHdr:cmodel.r[3]
MODEL_COMPONENT_7	Specifies the value of the component of the MODEL_COMPONENT_ID for the seventh element.	float array			<p>LOCATION</p> <ul style="list-style-type: none"> GEOMETRIC_CAMERA_MODEL (Group) <p>SOURCE</p> <ul style="list-style-type: none"> IDPH:ImgTImHdr:cmodel.e[3]
MODEL_COMPONENT_8	Specifies the value of the component of the MODEL_COMPONENT_ID for the eighth element.	float			<p>LOCATION</p> <ul style="list-style-type: none"> GEOMETRIC_CAMERA_MODEL (Group) <p>SOURCE</p> <ul style="list-style-type: none"> Conversion (integer to float): - IDPH:ImgTImHdr:cmodel.mtype
MODEL_COMPONENT_9	Specifies the value of the component of the MODEL_COMPONENT_ID for the ninth element.	float			<p>LOCATION</p> <ul style="list-style-type: none"> GEOMETRIC_CAMERA_MODEL (Group) <p>SOURCE</p> <ul style="list-style-type: none"> IDPH:ImgTImHdr:cmodel.mparm
MODEL_COMPONENT_ID	<p>Specifies a sequence of identifiers (usually 1 character), where each identifier corresponds to a model component vector. It is used in conjunction with the MODEL_COMPONENT_n elements, where "n" is a number. The first id in the sequence corresponds to MODEL_COMPONENT_1, the second corresponds to MODEL_COMPONENT_2, etc.</p> <p>For example, for a geometric camera model with a value of "CAHV" for MODEL_TYPE, the</p>	string array		<p>0 = "NONE" 1 = "(C,A,H,V)" 2 = "(C,A,H,V,O,R)" 3 = "(C,A,H,V,O,R,E,T,P)"</p>	<p>LOCATION</p> <ul style="list-style-type: none"> GEOMETRIC_CAMERA_MODEL (Group) <p>SOURCE</p> <ul style="list-style-type: none"> Table Lookup: - IDPH:ImgTImHdr:cmodel.mclass

Keyword Name	Definition	Type	Units	Valid Values	<ul style="list-style-type: none"> Location in PDS Label Source
	MODEL_COMPONENT_ID would be (C, A, H, V). Please see the MODEL_COMPONENT_NAME data element for more details.				
MODEL_COMPONENT_NAME	<p>Specifies a sequence of names, where each name identifies its corresponding model component vector.</p> <p>It is used in conjunction with the MODEL_COMPONENT_n elements, where "n" is a number. The first name in the sequence identifies MODEL_COMPONENT_1, the second identifies the MODEL_COMPONENT_2, etc.</p> <p>For example, for a geometric camera model with a value of "CAHV" for MODEL_TYPE, the MODEL_COMPONENT_NAME would be (CENTER, AXIS, HORIZONTAL, VERTICAL). The three values of MODEL_COMPONENT_1 would describe the focal center vector; the three values of MODEL_COMPONENT_2 would describe the pointing direction (axis) vector; the three values of MODEL_COMPONENT_3 would describe the horizontal image plane vector, and the three values of the MODEL_COMPONENT_4 would describe the vertical image plane vector.</p>	string array		<p>0 = NONE</p> <p>1 = ("CENTER", "AXIS", "HORIZONTAL", "VERTICAL")</p> <p>2 = ("CENTER", "AXIS", "HORIZONTAL", "VERTICAL", "OPTICAL", "RADIAL")</p> <p>3 = ("CENTER", "AXIS", "HORIZONTAL", "VERTICAL", "OPTICAL", "RADIAL", "ENTRANCE", "MTYPE", "MPARM")</p>	<p>LOCATION</p> <ul style="list-style-type: none"> GEOMETRIC_CAMERA_MODEL (Group) <p>SOURCE</p> <ul style="list-style-type: none"> Table Lookup: <ul style="list-style-type: none"> IDPH:ImgTlmHdr:cmodel.mclass
^MODEL_DESC	<p>Specifies a textual description of a model (or a pointer to a file containing the description). This is not intended to be a brief summary, but rather a detailed description of the model; at minimum, it should include a reference to a detailed description of the model in published literature.</p> <p>While other data elements such as CALIBRATION_SOURCE_ID, SOLUTION_ID, REFERENCE_COORD_SYSTEM_NAME, and MODEL_COMPONENT_NAME provide quick identifiers that distinguish how this model was generated, the details</p>	string		"GEOMETRIC_CM.TXT"	<p>LOCATION</p> <ul style="list-style-type: none"> GEOMETRIC_CAMERA_MODEL (Group) <p>SOURCE</p> <ul style="list-style-type: none"> Static Value

Keyword Name	Definition	Type	Units	Valid Values	<ul style="list-style-type: none"> Location in PDS Label Source
	and data behind each of these identifiers should be explicitly included in the model description.				
MODEL_TYPE	<p>Specifies an identifier for the type or kind of model. The value should be one of a well defined set, providing an application program with sufficient information to know how to handle the rest of the parameters within the model. (CAHVORE is the only one that uses model component vectors 1-9.)</p> <p>For details on the definitions of the valid camera model types, see [Ref 19] through [Ref 24].</p>	string(63)		0 = "NONE" 1 = "CAHV" 2 = "CAHVOR" 3 = "CAHVORE"	<p>LOCATION</p> <ul style="list-style-type: none"> GEOMETRIC_CAMERA_MODEL (Group) <p>SOURCE</p> <ul style="list-style-type: none"> Table Lookup: <ul style="list-style-type: none"> IDPH:ImgTImHdr:cmodel..mclass
^MOSAIC_DESC	Specifies a brief textual description of a mosaic.	string			<p>LOCATION</p> <ul style="list-style-type: none"> DERIVED_IMAGE_PARMS (Group) <p>SOURCE</p> <ul style="list-style-type: none"> Stafic Value
NOTE	Specifies a text field which provides miscellaneous notes or comments (for example, concerning a given data set or a given data processing program).	string			<p>LOCATION</p> <ul style="list-style-type: none"> GROUND_SUPPORT_EQUIPMENT (Group) <p>SOURCE</p> <ul style="list-style-type: none"> GSE Software
NUM_SOFTWARE_KEYWORDS	Specifies the number of keyword parameters that were supplied to the primary generating software named in SOFTWARE_MODULE_NAME. The PDS keywords that contain the software keyword names, values and types (if any) will be numbered 1, 2, 3, etc. PDS keywords named SOFTWARE_KEYWORD_NAME_<n> and SOFTWARE_KEYWORD_VALUE_<n> are required for each software keyword supplied, where the "n" takes the value {1, 2, 3, ...}.	integer			<p>LOCATION</p> <ul style="list-style-type: none"> DERIVED_IMAGE_PARMS (Group) <p>SOURCE</p> <ul style="list-style-type: none"> Image Processing Software
NUM_SOFTWARE_PARAMETERS	Specifies the number of positional parameters that were supplied to the primary generating software named in SOFTWARE_MODULE_NAME. The PDS keywords that contain the software parameter values, names and types (if any) will be numbered 1, 2, 3, etc. A PDS keyword named	integer			<p>LOCATION</p> <ul style="list-style-type: none"> DERIVED_IMAGE_PARMS (Group) <p>SOURCE</p> <ul style="list-style-type: none"> Image Processing Software

Keyword Name	Definition	Type	Units	Valid Values	<ul style="list-style-type: none"> Location in PDS Label Source
	SOFTWARE_PARAMETER_VALUE_<n> is required for each software parameter supplied, where the "n" takes the value {1, 2, 3, ...}.				
OBSERVATION_ID	Specifies a unique identifier for a scientific observation within a data set. It is set via the data product context ID - which doesn't necessarily map to a specific object - it's just used to group various instrument data sets together via a common keyword.	string			LOCATION <ul style="list-style-type: none"> IDENTIFICATION (Class) SOURCE <ul style="list-style-type: none"> IPDH:ImgTlmHdr:dpcid
OFFSET_MODE_ID	<p>Specifies the analog value that is subtracted from the video signal prior to the analog/digital converters.</p> <p>Because the keyword is of the "_ID" type, the value is a string. For MER, the integer range 0-4095 represents the range of valid string values.</p> <p>For MER, this is the video offset value in the CAPTURE_IMAGE command. Refer to the Pancam Calibration Report [Ref 14] or Pancam JGR paper [Ref 15] for more details.</p>	string		"0" to "4095"	LOCATION <ul style="list-style-type: none"> INSTRUMENT_STATE_PARMS (Group) SOURCE <ul style="list-style-type: none"> IDPH:ImgTlmHdr.voff
ORIGIN_OFFSET_VECTOR	<p>Specifies the offset from the reference coordinate system's origin to the origin of the coordinate system being defined by the enclosing COORDINATE_SYSTEM group. In other words, it is the location of the current system's origin as measured in the reference system.</p> <p>For MER, here is an example: In the case of the PMA_COORDINATE_SYSTEM group, ORIGIN_OFFSET_VECTOR describes the rotation of the PMA (camera head) boresight (about the ORIGIN_OFFSET_VECTOR) relative to the Rover frame.</p>	float array[3]	meters		LOCATION <ul style="list-style-type: none"> Group Dependent: <ul style="list-style-type: none"> a) IDD_COORDINATE_SYSTEM (Group) b) PMA_COORDINATE_SYSTEM (Group) c) ROVER_COORDINATE_SYSTEM (Group) d) LOCAL_LEVEL_COORDINATE_SYSTEM e) SITE_COORDINATE_SYSTEM SOURCE <ul style="list-style-type: none"> Group Dependent: <ul style="list-style-type: none"> a) IDPH:ImgTlmHdr:idd.pos[3] b) IDPH:ImgTlmHdr:pma_p.v[3] c) IDPH:ImgTlmHdr:rvr_p.v[3]
ORIGIN_ROTATION_QUATERNION	Specifies an array of four values that specifies the rotation of the coordinate system being defined by the enclosing COORDINATE_SYSTEM group, relative to the reference system. Mathematically this	float array[4]			LOCATION <ul style="list-style-type: none"> Group Dependent: <ul style="list-style-type: none"> a) IDD_COORDINATE_SYSTEM (Group) b) PMA_COORDINATE_SYSTEM (Group) c) ROVER_COORDINATE_SYSTEM

Keyword Name	Definition	Type	Units	Valid Values	<ul style="list-style-type: none"> Location in PDS Label Source
	<p>can be expressed as follows: Given a vector expressed in the current frame, multiplication by this quaternion will give the same vector as expressed in the reference frame. Quaternions are expressed as a set of four numbers in the order: (s, v1, v2, v3) where, s = cos(theta/2) v(n) = sin(theta/2)*a(n). theta = the angle of rotation a = (x,y,z) vector around which the rotation occurs.</p> <p>For MER, the value for ORIGIN_ROTATION_QUATERNION that defines a coordinate frame like Rover frame is computed with respect to only the orientations of the frame's axes... regardless of whether POSITIVE_ELEVATION_DIRECTION is declared to be "UP" or "DOWN".</p> <p>For MER, here is an example: In the case of the PMA_COORDINATE_SYSTEM group, ORIGIN_ROTATION_QUATERNION describes the rotation of the PMA (camera head) boresight (about the ORIGIN_OFFSET_VECTOR) relative to the Rover frame.</p>				<ul style="list-style-type: none"> (Group) d) LOCAL_LEVEL_COORDINATE_SYSTEM e) SITE_COORDINATE_SYSTEM <p>SOURCE</p> <ul style="list-style-type: none"> Group Dependent: <ul style="list-style-type: none"> a) IDPH:ImgTImHdr:idd.quaternion[4] b) IDPH:ImgTImHdr:pma_q.v[4] c) IDPH:ImgTImHdr:rvr_q.v[4] <p>For all the above, the Quaternion is received in the order: (v1, v2, v3, s)</p>
PACKET_MAP_MASK	<p>Specifies a binary or hexadecimal number identifying which of a data file's expected packets were actually received. The digits correspond positionally with the relative packet numbers of the data file. The bits are to be read left to right; i.e., the first (left-most) digit of the number corresponds to the first packet of the data file. A bit value of 1 indicates that the packet was received; a value of 0 indicates that it was not received.</p> <p>The number is stored in the PDS radix notation of <radix>#<value>#.</p>	non-decimal			<p>LOCATION</p> <ul style="list-style-type: none"> TELEMETRY (Class) <p>SOURCE</p> <ul style="list-style-type: none"> Calculation: <ul style="list-style-type: none"> - UPTH:PartNumber
PDS_VERSION_ID	Specifies the version number of the PDS	string(6)		"PDS3"	LOCATION

Keyword Name	Definition	Type	Units	Valid Values	<ul style="list-style-type: none"> Location in PDS Label Source
	<p>standards document that is valid when a data product label is created. Values for the PDS_version_id are formed by appending the integer for the latest version number to the letters 'PDS'.</p> <p>Examples: PDS3, PDS4.</p>				<ul style="list-style-type: none"> PDS required <p>SOURCE</p> <ul style="list-style-type: none"> PDS
PIXEL_AVERAGING_HEIGHT	Specifies the vertical dimension, in pixels, of the area over which pixels were averaged prior to image compression.	integer	pixel	"0" to "1024"	<p>LOCATION</p> <ul style="list-style-type: none"> Group Dependent: <ul style="list-style-type: none"> a) IMAGE_REQUEST_PARAMS (Group), b) INSTRUMENT_STATE_PARAMS (Group) <p>SOURCE</p> <ul style="list-style-type: none"> Group Dependent: <ul style="list-style-type: none"> a) IDPH:ImgParams:res_rows b) IDPH:ImgTlmHdr:res_rows
PIXEL_AVERAGING_WIDTH	Specifies the horizontal dimension, in pixels, of the area over which pixels were averaged prior to image compression.	integer	pixel	"0" to "1024"	<p>LOCATION</p> <ul style="list-style-type: none"> Group Dependent: <ul style="list-style-type: none"> a) IMAGE_REQUEST_PARAMS (Group) b) INSTRUMENT_STATE_PARAMS (Group) <p>SOURCE</p> <ul style="list-style-type: none"> Group Dependent: <ul style="list-style-type: none"> a) IDPH:ImgParams:res_cols b) IDPH:ImgTlmHdr:res_cols
PIXEL_DOWNSAMPLE_OPTION	<p>Specifies whether to downsample the image(s), and if so, which pixel resolution downsample method to use.</p> <p>Note for MER, if downsampling is specified, and two cameras are selected, both images will be downsampled. Note also that the camera hardware can downsample entire rows 4-to-1, but software must be used to do additional row-wise downsampling and any column downsampling.</p> <p>"SW_MEAN" - Downsampling done in software by calculation of the mean.</p> <p>"HW_SW" - Use hardware binning by changing the commanded downsampling and subframe arguments to be consistent with hardware binning. Any subsequent downsampling is done in software by calculation of the mean.</p>	string		<p>0 = "NONE" 1 = "SW_MEAN" 2 = "HW_COND" 3 = "HW_SW" 4 = "SW_OUTRJT" 5 = "SW_MEDIAN"</p>	<p>LOCATION</p> <ul style="list-style-type: none"> IMAGE_REQUEST_PARAMS (Group) <p>SOURCE</p> <ul style="list-style-type: none"> Table Lookup: <ul style="list-style-type: none"> - IDPH:ImgParams:resolution

Keyword Name	Definition	Type	Units	Valid Values	<ul style="list-style-type: none"> Location in PDS Label Source
	<p>"HW_COND" - Use hardware binning if downsampling (by mean calculation) and subframe arguments are consistent.</p> <p>"SW_OUTRTJ" -Software pixel averaging with outlier rejection. The pixel whose value lies farthest away from the mean of the sample is rejected.</p> <p>"SW_MEDIAN" - Software downsampling done by calculation of the median rather than the mean.</p>				
PLANET_DAY_NUMBER	<p>Specifies the number of sidereal days (rotation of 360 degrees) elapsed since a reference day (e.g., the day on which a landing vehicle set down). Days are measured in rotations of the planet in question from the reference day.</p> <p>For MER, the reference day is "1", as Landing day is Sol 1.</p>	integer		NOTE: Value will be uncalibrated if SPICE kernels are unavailable.	<p>LOCATION</p> <ul style="list-style-type: none"> IDENTIFICATION (Class) <p>SOURCE</p> <ul style="list-style-type: none"> Calculation: <ul style="list-style-type: none"> UPTH:DataValidityTime SCLK kernel
POSITIVE_AZIMUTH_DIRECTION	<p>Specifies the direction in which azimuth is measured in positive degrees for an observer on the surface of a body. The azimuth is measured with respect to the elevational reference plane. A value of CW indicates that Azimuth is measured positively Clockwise, and CCW indicates that Azimuth increases positively Counter-clockwise.</p> <p>For MER, an example is, if a Pancam image is taken of the sky at an elevation 45 degrees above the horizon, the elevation coordinate in MAST_FRAME would be +0.785398 radians.</p>	string		"CLOCKWISE", "COUNTERCLOCKWISE"	<p>LOCATION</p> <ul style="list-style-type: none"> Group Dependent: <ol style="list-style-type: none"> ROVER_COORDINATE_SYSTEM (Group) IDD_COORDINATE_SYSTEM (Group) PMA_COORDINATE_SYSTEM (Group) LOCAL_LEVEL_COORDINATE_SYSTEM SITE_COORDINATE_SYSTEM <p>SOURCE</p> <ul style="list-style-type: none"> Group Dependent, Static Value: <ul style="list-style-type: none"> Value determined by MER coordinate frame definitions.
POSITIVE_ELEVATION_DIRECTION	<p>Specifies the direction in which elevation is measured in positive degrees for an observer on the surface of a body. The elevation is measured with respect to the azimuthal reference plane.</p> <p>A value of "UP" indicates that elevation is measured positively upwards, i.e., the zenith point would be at +90 degrees and</p>	string		"UP", "DOWN"	<p>LOCATION</p> <ul style="list-style-type: none"> Group Dependent: <ol style="list-style-type: none"> ROVER_COORDINATE_SYSTEM (Group) IDD_COORDINATE_SYSTEM (Group) PMA_COORDINATE_SYSTEM (Group) LOCAL_LEVEL_COORDINATE_SYSTEM SITE_COORDINATE_SYSTEM

Keyword Name	Definition	Type	Units	Valid Values	<ul style="list-style-type: none"> Location in PDS Label Source
	<p>the nadir point at -90 degrees. "DOWN" indicates that the elevation is measured positively downwards; the zenith point would be at -90 degrees and the nadir point at +90 degrees.</p> <p>For the MER operational coordinate frames, which follow the Mars Pathfinder convention, increasing elevation ("UP") moves towards the negative Z axis.</p>				<p>SOURCE</p> <ul style="list-style-type: none"> Group Dependent, Static Value: <ul style="list-style-type: none"> Value determined by MER coordinate frame definitions.
PRESSURE	Specifies the type of pressure used in instrument calibrations.	string		"AMBIENT"	<p>LOCATION</p> <ul style="list-style-type: none"> GROUND_SUPPORT_EQUIPMENT (Group) <p>SOURCE</p> <ul style="list-style-type: none"> GSE Software
PROCESSING_HISTORY_TEXT	Specifies an entry for each processing step and program used in generating a particular data file.	string		"CODMAC LEVEL 1 TO LEVEL 2 CONVERSION VIA JPL/MIPL MERTELEMPROC"	<p>LOCATION</p> <ul style="list-style-type: none"> HISTORY (Class) <p>SOURCE</p> <ul style="list-style-type: none"> Static Value
PRODUCER_FULL_NAME	<p>Specifies the full, unabbreviated name of the individual mainly responsible for the production of the data set.</p> <p>Example: "JOE SMITH"</p>	string			<p>LOCATION</p> <ul style="list-style-type: none"> GROUND_SUPPORT_EQUIPMENT (Group) <p>SOURCE</p> <ul style="list-style-type: none"> GSE Software
PROCESSING_INFO	Specifies information about the processing used to generate the RDR that is not covered by other PDS label keywords.	string array			<p>LOCATION</p> <ul style="list-style-type: none"> DERIVED_IMAGE_PARMS (Group) <p>SOURCE</p> <ul style="list-style-type: none"> Image Processing Software
PRODUCER_INSTITUTION_NAME	Specifies the identity of a university, research center, NASA center or other institution associated with the production of a data set. This would generally be an institution associated with the element PRODUCER_FULL_NAME.	string(60)		"MULTIMISSION IMAGE PROCESSING SUBSYSTEM, JET PROPULSION LAB"	<p>LOCATION</p> <ul style="list-style-type: none"> IDENTIFICATION (Class) <p>SOURCE</p> <ul style="list-style-type: none"> Static Value
PRODUCT_CREATION_TIME	Specifies the UTC system format for the time when a product was created.	string		YYYY-MM-DDThh:mm:ss[.fff]Z	<p>LOCATION</p> <ul style="list-style-type: none"> IDENTIFICATION (Class) <p>SOURCE</p> <ul style="list-style-type: none"> Calculation
PRODUCT_ID	<p>Specifies a permanent, unique identifier assigned to a data product by its producer.</p> <p>For MER, it is the filename minus the</p>	string(40)			<p>LOCATION</p> <ul style="list-style-type: none"> IDENTIFICATION (Class) <p>SOURCE</p>

Keyword Name	Definition	Type	Units	Valid Values	<ul style="list-style-type: none"> Location in PDS Label Source
	<p>extension.</p> <p>Note: In the PDS, the value assigned to product_id must be unique within its data set.</p> <p>Additional note: The PRODUCT_ID can describe the lowest-level data object that has a PDS label.</p>				<ul style="list-style-type: none"> Filename minus the extension.
PRODUCT_VERSION_ID	<p>Specifies the version of an individual product within a data set.</p> <p>PRODUCT_VERSION_ID is intended for use within AMMOS to identify separate iterations of a given product, which will also have a unique FILE_NAME.</p> <p>For MER, PRODUCT_VERSION_ID includes a Version field that begins with "V" followed by the Version decimal number of the controlling SIS document.</p> <p>Example:</p> <p>"V2.0 D-22846"</p> <p>NOTE: This might not be the same as the data set version that is an element of the DATA_SET_ID value.</p>	string(12)		"V<vernum> D-22846"	<p>LOCATION</p> <ul style="list-style-type: none"> IDENTIFICATION (Class) <p>SOURCE</p> <ul style="list-style-type: none"> Static Value
PROJECTION_AXIS_OFFSET	<p>Specifies the radius of a circle, where the circle represents the rotation around the projection origin by the synthetic or fictitious camera used to calculate each column in the Cylindrical-Perspective projection. The radius is the distance from the camera to the origin.</p> <p>If the value is positive, the fictitious camera is to the right of the origin when seen from behind (i.e. in the direction of its boresight). If negative, the camera is on the left. If the keyword does not appear, it is assumed to be 0, i.e. the camera rotates in place without describing a circle.</p>	float	meters (<m> unit tag required)		<p>LOCATION</p> <ul style="list-style-type: none"> SURFACE_PROJECTION_PARMS (Group) <p>SOURCE</p> <ul style="list-style-type: none"> Image Processing Software
PROJECTION_AZIMUTH	<p>Specifies the azimuth, in degrees, of the horizontal center of projection for the</p>	float	deg		<p>LOCATION</p> <ul style="list-style-type: none"> SURFACE_PROJECTION_PARMS (Group)

Keyword Name	Definition	Type	Units	Valid Values	<ul style="list-style-type: none"> Location in PDS Label Source
	<p>PERSPECTIVE projection (loosely, where the camera model is pointing).</p> <p>For the Cylindrical-Perspective projection, it defines the angle at which the synthetic camera for each column is rotated relative to the vector tangent to the circle described by the camera center (see PROJECTION_AXIS_OFFSET). This is used to model toe-in of the synthetic camera. A positive value rotates the camera counterclockwise when seen from above, so PROJECTION_AZIMUTH and PROJECTION_AXIS_OFFSET share the same sign then the synthetic camera is toed in.</p> <p>Absence of the keyword does not indicate the azimuth (toe-in) is zero. Instead, the camera model group implicitly defines the amount of toe-in via the A vector.</p>		(<deg> unit tag required)		<p>SOURCE</p> <ul style="list-style-type: none"> Image Processing Software
PROJECTION_ELEVATION	Specifies the elevation, in degrees, of the vertical center of projection (loosely, where the camera is pointing). For PERSPECTIVE, this applies to the single output camera model; for CYLINDRICAL-PERSPECTIVE it applies to each column's output camera model.	float	deg (<deg> unit tag required)		<p>LOCATION</p> <ul style="list-style-type: none"> SURFACE_PROJECTION_PARMS (Group) <p>SOURCE</p> <ul style="list-style-type: none"> Image Processing Software
PROJECTION_ELEVATION_LINE	Specifies the image line which corresponds to PROJECTION_ELEVATION for each column of the CYLINDRICAL-PERSPECTIVE projection.	float	pixel (<pixel> unit tag required)		<p>LOCATION</p> <ul style="list-style-type: none"> SURFACE_PROJECTION_PARMS (Group) <p>SOURCE</p> <ul style="list-style-type: none"> Image Processing Software
PROJECTION_ORIGIN_VECTOR	<p>Specifies the location of origin of the projection. This is an xyz point from which all the azimuth/elevation rays emanate.</p> <p>Applies to Polar, Cylindrical, Cylindrical-Perspective and Orthographic projections.</p> <p>For the Cylindrical-Perspective projection, this is the point around which the synthetic camera orbits. If the value is not present, it can be derived from the C vector of the camera model group (in which case the PROJECTION_AXIS_OFFSET should be</p>	float array[3]	meters (<m> unit tag required)		<p>LOCATION</p> <ul style="list-style-type: none"> SURFACE_PROJECTION_PARMS (Group) <p>SOURCE</p> <ul style="list-style-type: none"> Image Processing Software

Keyword Name	Definition	Type	Units	Valid Values	<ul style="list-style-type: none"> Location in PDS Label Source
	0). For the Orthographic projection, the PROJECTION_ORIGIN_VECTOR defines a point in a plane normal to the direction of projection (given by PROJECTION_Z_AXIS_VECTOR) that serves as the origin. All points that lie on a line through the PROJECTION_ORIGIN_VECTOR in the direction of the PROJECTION_Z_AXIS_VECTOR will be located at X=Y=0 in the orthographic projection.				
PROJECTION_X_AXIS_VECTOR	Specifies a unit vector giving the direction of the X-axis lying within the plane of projection for the orthographic projection. Note: Required if and only if MAP_PROJECTION_TYPE = "ORTHOGRAPHIC". Note: This is only one of several equivalent ways that the orientation of the orthographic projection might be specified (others are by a 3x3 rotation matrix with rows equal to these vectors, as three Euler angles, or as a unit quaternion).	float array[3]	meters (<m> unit tag required)		LOCATION <ul style="list-style-type: none"> SURFACE_PROJECTION_PARS (Group) SOURCE <ul style="list-style-type: none"> Image Processing Software
PROJECTION_Y_AXIS_VECTOR	Specifies a unit vector giving the direction of the Y-axis lying within the plane of projection for the orthographic projection. Note: Required if and only if MAP_PROJECTION_TYPE = "ORTHOGRAPHIC". Note: This is only one of several equivalent ways that the orientation of the orthographic projection might be specified (others are by a 3x3 rotation matrix with rows equal to these vectors, as three Euler angles, or as a unit quaternion).	float array[3]	meters (<m> unit tag required)		LOCATION <ul style="list-style-type: none"> SURFACE_PROJECTION_PARS (Group) SOURCE <ul style="list-style-type: none"> Image Processing Software
PROJECTION_Z_AXIS_VECTOR	Specifies a unit vector giving the direction of the Z-axis lying within the plane of projection for the orthographic projection.	float array[3]	meters (<m> unit tag required)		LOCATION <ul style="list-style-type: none"> SURFACE_PROJECTION_PARS (Group) SOURCE

Keyword Name	Definition	Type	Units	Valid Values	<ul style="list-style-type: none"> Location in PDS Label Source
	<p>Note: Required if and only if MAP_PROJECTION_TYPE = "ORTHOGRAPHIC".</p> <p>Note: This is only one of several equivalent ways that the orientation of the orthographic projection might be specified (others are by a 3x3 rotation matrix with rows equal to these vectors, as three Euler angles, or as a unit quaternion).</p>		required)		<ul style="list-style-type: none"> Image Processing Software
QUATERNION_MEASUREMENT_METHOD	<p>Specifies the quality of the rover orientation estimate. Valid values are:</p> <p>"UNKNOWN" – The attitude should simply not be trusted. This is the initial grade given on Landing, for example.</p> <p>"TILT_ONLY" – The attitude estimate is only good for tilt determination (2-axis knowledge). Activities which require azimuth knowledge should be careful.</p> <p>"COARSE" – The attitude estimate is "complete" (it has all three axes) but is crude. This can occur because a sungaze has not yet been performed or because some event (such as traverses or IDD activity) have reduced the quality of the estimate (a.k.a. "ThreeAxisCoarse").</p> <p>"FINE" – Sungaze completed successfully, and the attitude estimate is sufficient for pointing HGA (a.k.a. "ThreeAxisFine").</p>	string		<p>0 = "UNKNOWN"</p> <p>1 = "TILT_ONLY"</p> <p>2 = "COARSE"</p> <p>3 = "FINE"</p>	<p>LOCATION</p> <ul style="list-style-type: none"> ROVER_COORDINATE_SYSTEM (Group) <p>SOURCE</p> <ul style="list-style-type: none"> Table Lookup: <ul style="list-style-type: none"> ImgTlmHdr:rvr_adianc
RADIANCE_OFFSET	<p>Specifies the constant value by which a stored radiance is added.</p> <p>Note: Expressed as an equation: $true_radiance_value = radiance_offset + radiance_scaling_factor * stored_radiance_value.$</p> <p>There are 3 types of radiometric corrections:</p> <p><u>Radiance-calibrated RDRs</u> In Pancam case, these "RAD" (and "RAL")</p>	float	<p>"RAD"</p> <p>WATT*</p> <p>M**-2*</p> <p>NM**-1*</p> <p>SR**-1</p> <p>"IOF"</p> <p>Unitless</p> <p>I/F</p> <p>"CCD"</p>		<p>LOCATION</p> <ul style="list-style-type: none"> DERIVED_IMAGE_PARMS (Group) IMAGE (Object) <p>SOURCE</p> <ul style="list-style-type: none"> Image Processing Software

Keyword Name	Definition	Type	Units	Valid Values	<ul style="list-style-type: none"> Location in PDS Label Source
	<p>RDRs have been scaled to absolute radiance units using either pre-flight radiometric calibration coefficients or calibration coefficients derived from in-flight observations of the Pancam calibration target. The units on these files are (W/m²/nm/sr).</p> <p><u>Radiance factor-calibrated RDRs</u> These "IOF" (and "IOL") RDRs are unitless but have values in the range of 0.0 to 1.0 (for example, average bright Mars soils exhibit I/F ~ 0.35 at 750 nm and I/F ~ 0.05 at 410 nm).</p> <p><u>Instrumentally-calibrated RDRs</u> These "CCD" (and "CCL") RDRs have had no radiance scaling applied, so the units on these files are "corrected" DN.</p>		DN		
RADIANCE_SCALING_FACTOR	<p>Specifies the constant value by which a stored radiance is multiplied.</p> <p>Note: Expressed as an equation: true_radiance_value = radiance_offset + radiance_scaling_factor*stored_radiance_value</p> <p>There are 3 types of radiometric corrections:</p> <p><u>Radiance-calibrated RDRs</u> In Pancam case, these "RAD" (and "RAL") RDRs have been scaled to absolute radiance units using either pre-flight radiometric calibration coefficients or calibration coefficients derived from in-flight observations of the Pancam calibration target. The units on these files are (W/m²/nm/sr).</p> <p><u>Radiance factor-calibrated RDRs</u> These "IOF" (and "IOL") RDRs are unitless but have values in the range of 0.0 to 1.0 (for example, average bright Mars soils exhibit I/F ~ 0.35 at 750 nm and I/F ~ 0.05 at 410 nm).</p>	float	<p>"RAD" WATT* M**-2* NM**-1* SR**-1</p> <p>"IOF" Unitless I/F</p> <p>"CCD" DN</p>		<p>LOCATION</p> <ul style="list-style-type: none"> DERIVED_IMAGE_PARAMS (Group) IMAGE (Object) <p>SOURCE</p> <ul style="list-style-type: none"> Image Processing Software

Keyword Name	Definition	Type	Units	Valid Values	<ul style="list-style-type: none"> Location in PDS Label Source
	<p><u>Instrumentally-calibrated RDRs</u> These "CCD" (and "CCL") RDRs have had no radiance scaling applied, so the units on these files are "corrected" DN.</p>				
RADIOMETRIC_CORRECTION_TYPE	<p>Identifies the method used for radiometric correction.</p> <p>Values include "PANCAL" for the correction done by the science team at Cornell, "MIPLRAD" for the MIPL correction (flat-field, exposure and temperature only), or "NONE" for the case when no radiometric correction has been performed.</p>	string		"PANCAL", "MIPLRAD", "NONE"	<p>LOCATION</p> <ul style="list-style-type: none"> DERIVED_IMAGE_PARMS (Group) <p>SOURCE</p> <ul style="list-style-type: none"> Image Processing Software
RANGE_ORIGIN_VECTOR	<p>Specifies the 3-D space from which the Range values are measured in a Range RDR. This will normally be the same as the C point of the camera. It is expressed in the coordinate system specified by the REFERENCE_COORD_SYSTEM_* keywords in the enclosing DERIVED_IMAGE_PARMS group.</p>	float array[3]			<p>LOCATION</p> <ul style="list-style-type: none"> DERIVED_IMAGE_PARMS <p>SOURCE</p> <ul style="list-style-type: none"> IDPH:ImgTImHdr:cmodel.c[3]
RECEIVED_PACKETS	<p>Specifies the total number of telemetry packets which constitute a reconstructed data product.</p>	integer			<p>LOCATION</p> <ul style="list-style-type: none"> TELEMETRY (Class) <p>SOURCE</p> <ul style="list-style-type: none"> Calculation: <ul style="list-style-type: none"> - UPTH:PacketNumber
RECORD_BYTES	<p>Specifies the number of bytes in a physical file record, including record terminators and separators.</p> <p>Note: In the PDS, the use of record_bytes, along with other file-related data elements is fully described in the Standards Reference.</p>	integer		"0" to n	<p>LOCATION</p> <ul style="list-style-type: none"> FILE (Class) <p>SOURCE</p> <ul style="list-style-type: none"> Calculation
RECORD_TYPE	<p>Specifies the record format of a file.</p> <p>Note: In the PDS, when record_type is used in a detached label file it always describes its corresponding detached data file, not the label file itself. The use of record_type along with other file-related data elements is fully described in the PDS Standards Reference.</p>	string(20)		"FIXED_LENGTH"	<p>LOCATION</p> <ul style="list-style-type: none"> FILE (Class) <p>SOURCE</p> <ul style="list-style-type: none"> Static Value
REFERENCE_AZIMUTH	<p>Specifies the azimuth of the line extending from the center of the image to the top</p>	float	deg		<p>LOCATION</p> <ul style="list-style-type: none"> SURFACE_PROJECTION_PARMS (Group)

Keyword Name	Definition	Type	Units	Valid Values	<ul style="list-style-type: none"> Location in PDS Label Source
	center of the image with respect to a polar projection.		(<deg> unit tag required)		SOURCE <ul style="list-style-type: none"> Image Processing Software
REFERENCE_COORD_SYSTEM_INDEX	<p>Specifies which instance of the coordinate system named by REFERENCE_COORD_SYSTEM_NAME is the reference coordinate system for the group in which the keyword occurs. This index is a set of integers which serve to identify coordinate system instances in a mission-specific manner.</p> <p>For MER, the indices are based on the ROVER_MOTION_COUNTER. This counter is incremented each time the rover moves (or may potentially have moved, e.g. due to arm motion). The full counter may have up to 5 values (SITE, DRIVE, IDD, PMA, HGA), but normally only the first value (for SITE frames) or the first two values (for LOCAL_LEVEL or ROVER frames) are used for defining reference coordinate system instances. It is legal to use any number of indices to describe a reference coordinate system instance, however.</p> <p>See also REFERENCE_COORD_SYSTEM_NAME and COORDINATE_SYSTEM_INDEX.</p>	integer array[5]			LOCATION <ul style="list-style-type: none"> GEOMETRIC_CAMERA_MODEL (Group) ROVER_COORDINATE_SYSTEM (Group) IDD_COORDINATE_SYSTEM (Group) PMA_COORDINATE_SYSTEM (Group) LOCAL_LEVEL_COORDINATE_SYSTEM SITE_COORDINATE_SYSTEM ROVER_DERIVED_GEOMETRY_PARMS (Group) SITE_DERIVED_GEOMETRY_PARMS (Group) DERIVED_IMAGE_PARMS (Group) SURFACE_PROJECTION_PARMS (Group) SURFACE_MODEL_PARMS (Group) SOURCE <ul style="list-style-type: none"> Number of values used is group dependent: <ul style="list-style-type: none"> IDPH:ImgTImHdr:rmc NOTES: <u>Defaults for EDRs</u> <ul style="list-style-type: none"> If ROVER_FRAME, then SITE, DRIVE, IDD, PMA, and HGA indices If SITE_FRAME, then SITE index If MAST_FRAME, then SITE, DRIVE, IDD, PMA, and HGA indices If LOCAL_LEVEL_FRAME, then SITE, DRIVE, IDD, PMA, and HGA indices APXS_FRAME MB_FRAME MI_FRAME If RAT_FRAME, then SITE, DRIVE, IDD, PMA, and HGA indices <u>Defaults for RDRs</u> <ul style="list-style-type: none"> Software and activity dependent.
REFERENCE_COORD_SYSTEM_NAME	Specifies the full name of the reference coordinate system for the group in which the keyword occurs. All vectors and positions relating to 3-D space within the enclosing group are expressed using this reference coordinate system. Non-unique coordinate	string(20)		<u>EDRs</u> "ROVER_FRAME", "ROVER_FRAME_UP", "SITE_FRAME", "SITE_FRAME_UP", "MAST_FRAME", "PANCAM_FRAME",	LOCATION <ul style="list-style-type: none"> GEOMETRIC_CAMERA_MODEL (Group) ROVER_COORDINATE_SYSTEM (Group) IDD_COORDINATE_SYSTEM (Group) PMA_COORDINATE_SYSTEM (Group) LOCAL_LEVEL_COORDINATE_SYSTEM

Keyword Name	Definition	Type	Units	Valid Values	<ul style="list-style-type: none"> Location in PDS Label Source
	<p>systems (such as "SITE" for rover missions), which have multiple instances using the same name, also require REFERENCE_COORD_SYSTEM_INDEX to completely identify the reference coordinate system.</p> <p>For MER, the reference is usually a SITE frame.</p> <p>Note: For RDRs, a value of "GENERIC FIXED" denotes ???</p>			<p>"LOCAL_LEVEL_FRAME", "LOCAL_LEVEL_FRAME_UP", "LANDER_FRAME", "LANDER_FRAME_UP", "MI_FRAME", "MI_FRAME_UP"</p> <p>RDRs "GENERIC FIXED"</p>	<ul style="list-style-type: none"> (Group) SITE_COORDINATE_SYSTEM (Group) ROVER_DERIVED_GEOMETRY_PARMS (Group) SITE_DERIVED_GEOMETRY_PARMS (Group) DERIVED_IMAGE_PARMS (Group) SURFACE_PROJECTION_PARMS (Group) SURFACE_MODEL_PARMS (Group) <p>SOURCE</p> <ul style="list-style-type: none"> Software dependent
REFERENCE_COORD_SYSTEM_SOLN_ID	See SOLUTION_ID.	string			<p>LOCATION</p> <ul style="list-style-type: none"> GEOMETRIC_CAMERA_MODEL (Group) ROVER_COORDINATE_SYSTEM (Group) IDD_COORDINATE_SYSTEM (Group) PMA_COORDINATE_SYSTEM (Group) LOCAL_LEVEL_COORDINATE_SYSTEM (Group) SITE_COORDINATE_SYSTEM (Group) ROVER_DERIVED_GEOMETRY_PARMS (Group) SITE_DERIVED_GEOMETRY_PARMS (Group) DERIVED_IMAGE_PARMS (Group) SURFACE_PROJECTION_PARMS (Group) SURFACE_MODEL_PARMS (Group) <p>SOURCE</p> <ul style="list-style-type: none"> Image Processing Software
REFERENCE_PIXEL_IMAGE	<p>Specifies the value of PRODUCT_ID for the reference pixel EDR that was used to remove bias in generating the RDR.</p> <p>Note: If the model rather than a reference pixel EDR was used to remove the bias then this keyword is not included in the PDS label.</p>	string			<p>LOCATION</p> <ul style="list-style-type: none"> DERIVED_IMAGE_PARMS (Group) <p>SOURCE</p> <ul style="list-style-type: none"> Image Processing Software
RELEASE_ID	Specifies the unique identifier associated with the release to the public of all or part of a data set. The release number is associated with the data set, not the mission.	string			<p>LOCATION</p> <ul style="list-style-type: none"> IDENTIFICATION (Class) <p>SOURCE</p> <ul style="list-style-type: none"> User Parameter

Keyword Name	Definition	Type	Units	Valid Values	<ul style="list-style-type: none"> • Location in PDS Label • Source
	<p>When a data set is released incrementally, such as every three months during a mission, the RELEASE_ID is updated each time part of the data set is released. For each Rover mission, the first release of a data set should have a value of "0001".</p> <p>For example, the first release of the Pancam EDR data set on MER-1 will be August 3, 2004 (according to the Archive Plan), so those products will have RELEASE_ID = "0001". The next Pancam EDR release will be October 4, 2004, so those products will have RELEASE_ID = "0002". The Pancam EDRs from the other rover are a separate data set. Those will be released August 24, 2004 (RELEASE_ID = "0001") and October 25, 2004 (RELEASE_ID = "0002").</p>				
RESPONSIVITY_CONSTANTS	Specifies the array of responsivity constants used in generating the RDR.	float array			<p>LOCATION</p> <ul style="list-style-type: none"> • DERIVED_IMAGE_PARMS (Group) <p>SOURCE</p> <ul style="list-style-type: none"> • Image Processing Software
RESPONSIVITY_CONSTANTS_FILE	Specifies the name of the responsivity constants file used in generating the RDR.	string			<p>LOCATION</p> <ul style="list-style-type: none"> • DERIVED_IMAGE_PARMS (Group) <p>SOURCE</p> <ul style="list-style-type: none"> • Image Processing Software
ROVER_MOTION_COUNTER	Specifies a set of integers which describe a (potentially) unique location (position/orientation) for a rover. Each time something happens that moves, or could potentially move, the rover, a new motion counter value is created. This includes intentional motion due to drive commands, as well as potential motion due to other articulating devices, such as arms or antennae. This motion counter (or part of it) is used as a reference to define instances of coordinate systems which can move such as SITE or ROVER frames. The motion counter is defined in a mission-specific manner. Although the original intent was to have incrementing indices (e.g. MER), the motion counter could also	integer array[5]			<p>LOCATION</p> <ul style="list-style-type: none"> • IDENTIFICATION (Class) <p>SOURCE</p> <ul style="list-style-type: none"> • IDPH:ImgTImHdr:rmc

Keyword Name	Definition	Type	Units	Valid Values	<ul style="list-style-type: none"> Location in PDS Label Source
	<p>contain any integer values which conform to the above definition, such as time or spacecraft clock values.</p> <p>For MER, the motion counter consists of five values. In order, they are Site, Drive, IDD, PMA, and HGA. The Site value increments whenever a new major Site frame is declared. The Drive value increments any time intentional driving is done. Each of those resets all later indices to 0 when they increment. The IDD, PMA, and HGA increment whenever the corresponding articulation device moves. IDD, PMA and HGA increment independently of each other; they are reset to zero only when the Site or Drive changes.</p> <p>Conceptually, a sixth value could be added by ground processing to indicate unintentional slippage (e.g. the wind blew the rover off a rock). This sixth value will never occur in telemetry but might occur in certain RDR's. However, this was NOT implemented for MER.</p>				
ROVER_MOTION_COUNTER_NAME	Specifies an array that provides the formal names identifying each integer in ROVER_MOTION_COUNTER.	string array[5]		("SITE", "DRIVE", "IDD", "PMA", "HGA")	<p>LOCATION</p> <ul style="list-style-type: none"> IDENTIFICATION (Class) <p>SOURCE</p> <ul style="list-style-type: none"> Static Value
SAMPLE_BITS	Specifies the stored number of bits, or units of binary information, contained in a LINE_SAMPLE value.	integer		"1", "2", "4", "8", "16", "32", "64"	<p>LOCATION</p> <ul style="list-style-type: none"> IMAGE (Object) <p>SOURCE</p> <ul style="list-style-type: none"> Calculation: <ul style="list-style-type: none"> IDPH:ImgTImHdr:scale IDPH:ImgTImHdr:hw_scale
SAMPLE_BIT_MASK	Specifies the active bits in a sample. Note: In the PDS, the domain of SAMPLE_BIT_MASK is dependent upon the currently-described value in the SAMPLE_BITS element and only applies to integer values.	non-decimal			<p>LOCATION</p> <ul style="list-style-type: none"> IMAGE (Object) <p>SOURCE</p> <ul style="list-style-type: none"> Calculation: <ul style="list-style-type: none"> IDPH:ImgTImHdr:scale IDPH:ImgTImHdr:hw_scale

Keyword Name	Definition	Type	Units	Valid Values	<ul style="list-style-type: none"> Location in PDS Label Source
	For an 8-bit sample returned as a signed 16-bit integer, only the 8 lower order bits are active, so the SAMPLE_BIT_MASK would be 2#0000000011111111#.				
SAMPLE_BIT_METHOD	<p>Specifies the method in which bit scaling is performed.</p> <p>For MER, the bit scaling is a 12-bit to 8-bit scaling and can be performed onboard via hardware, software or both.</p> <p>Note that values "HARDWARE_INVERTED" and "SOFTWARE_INVERTED" indicate that an Inverse Lookup Table (ILUT) was applied during ground processing to 8-bit data, scaling the lowest 8 bits in the signed 16-bit integer to the lowest 12 bits. This characterizes the Scaled 12-bit version of the Science EDR (SOAS), and the Inverse LUT RDR (OPGS).</p>	string		"NONE", "HARDWARE", "SOFTWARE", "HARDWARE_INVERTED", "SOFTWARE_INVERTED"	<p>LOCATION</p> <ul style="list-style-type: none"> INSTRUMENT_STATE_PARMs (Group) <p>SOURCE</p> <ul style="list-style-type: none"> Calculated: <ul style="list-style-type: none"> IDPH:ImgTImHdr:scale IDPH:ImgTImHdr:hw_scale <p>NOTES: If hw_scale is true and scale=11 then "HARDWARE". If hw_scale is false and scale is > 0 then "SOFTWARE"</p>
SAMPLE_BIT_MODE_ID	<p>Specifies the type of pixel scaling performed.</p> <p>For MER, pixel scaling is accomplished by using onboard lookup tables or by shifting a specified bit into the most significant bit.</p> <p>0 = NONE - no scaling ; keep as 12-bit (if available) LUT1 - use lookup table 1 LUT2 - use lookup table 2 LUT3 - use lookup table 3 LUT4 - use lookup table 4 LUT5 - use lookup table 5 UNDEF - undefined MSB_BIT7 - no scaling, make bit 7 most significant bit MSB_BIT8 - shift to make bit 8 most significant bit MSB_BIT9 - shift to make bit 9 most significant bit MSB_BIT10 - shift to make bit 10 most significant bit MSB_BIT11 - shift to make bit 11 most significant bit AUTOSHIFT - auto-shift to keep highest</p>	string		0 = "NONE" 1 = "LUT1" 2 = "LUT2" 3 = "LUT3" 4 = "LUT4" 5 = "LUT5" 6 = "UNDEF" 7 = "MSB_BIT7" 8 = "MSB_BIT8" 9 = "MSB_BIT9" 10 = "MSB_BIT10" 11 = "MSB_BIT11" 255 = "AUTOSHIFT"	<p>LOCATION</p> <ul style="list-style-type: none"> Group Dependent: <ol style="list-style-type: none"> IMAGE_REQUEST_PARMs (Group) THUMBNAIl_REQUEST_PARMs (Group) INSTRUMENT_STATE_PARMs (Group) <p>SOURCE</p> <ul style="list-style-type: none"> Group Dependent, Table Lookup: <ol style="list-style-type: none"> IDPH:ImgParams:scale IDPH:ImgParams:thumb_scale IDPH:ImgTImHdr:scale

Keyword Name	Definition	Type	Units	Valid Values	<ul style="list-style-type: none"> Location in PDS Label Source
	value				
SAMPLE_CAMERA_MODEL_OFFSET	Specifies the location of the image origin with respect to the camera model's origin. For CAHV/CAHVOR models, this origin is not the center of the camera, but is the upper-left corner of the "standard"-size image, which is encoded in the CAHV vectors. (MIPL Projections - Perspective)	float	pixel (<pixel> unit tag required)		LOCATION <ul style="list-style-type: none"> SURFACE_PROJECTION_PARMS (Group) SOURCE <ul style="list-style-type: none"> Image Processing Software
SAMPLE_PROJECTION_OFFSET	Specifies the sample coordinate of the location in the image of the "special" point of the mosaic. For Polar projections, this is the nadir of the polar projection. For Vertical and Orthographic projections, this is the origin of the projected coordinate system grid (i.e., X=0.0, Y=0.0). Not applicable to other projections.	float	pixel		LOCATION <ul style="list-style-type: none"> SURFACE_PROJECTION_PARMS (Group) SOURCE <ul style="list-style-type: none"> Image Processing Software
SAMPLE_TYPE	Specifies the data storage representation of sample value. The valid values are platform dependent. Suns and Macs and JAVA are MSB and IEEE_REAL. INTEL based machines usually running windows or linux are LSB integers and PC_REAL.	string(30)		"IEEE_REAL", "MSB_INTEGER", "MSB_UNSIGNED_INTEGER", "PC_REAL", "LSB_INTEGER", "LSB_UNSIGNED_INTEGER"	LOCATION <ul style="list-style-type: none"> IMAGE (Object) SOURCE <ul style="list-style-type: none"> Based on: <ul style="list-style-type: none"> IDPH:ImgTImHdr:scale IDPH:ImgTImHdr:hw_scale platform
SEQUENCE_ID	Specifies an identification of the spacecraft sequence associated with the given product. This element replaces the older seq_id, which should no longer be used.	string(30)			LOCATION <ul style="list-style-type: none"> IDENTIFICATION (Class) SOURCE <ul style="list-style-type: none"> UPTH:PrdCmdID:SequenceID
SEQUENCE_VERSION_ID	Specifies the version identifier for a particular observation sequence used during planning or data processing.	string(30)			LOCATION <ul style="list-style-type: none"> IDENTIFICATION (Class) SOURCE <ul style="list-style-type: none"> UPTH:PrdCmdID:SequenceVersion
SHUTTER_CORRECTION_MODE_ID	Specifies whether shutter subtraction will be performed.	string		0 = "FALSE" 1 = "CONDITIONAL" 2 = "TRUE"	LOCATION <ul style="list-style-type: none"> OBSERVATION_REQUEST_PARMS (Group) SOURCE <ul style="list-style-type: none"> Table Lookup: <ul style="list-style-type: none"> IDPH:ImgParams:shutter
SHUTTER_CORRECT_THRESH_COUNT	Specifies the exposure time threshold for conditional shutter subtraction.	unsigned integer	5.1 ms	"0" to "65535"	LOCATION <ul style="list-style-type: none"> OBSERVATION_REQUEST_PARMS (Group)

Keyword Name	Definition	Type	Units	Valid Values	<ul style="list-style-type: none"> Location in PDS Label Source
	For MER, the count is in increments of 5.1 ms.				SOURCE <ul style="list-style-type: none"> IDPH:ImgParams:shutter_thresh
SHUTTER_EFFECT_CORRECTION_FLAG	Specifies whether or not a shutter effect correction was applied to the image. The shutter effect correction involves the removal from the image of the shutter, or fixed-pattern.	string(5)		0 = "FALSE" 1 = "TRUE"	LOCATION <ul style="list-style-type: none"> INSTRUMENT_STATE_PARMS (Group) SOURCE <ul style="list-style-type: none"> IDPH:ImgTImHdr:shutter
SOFTWARE_KEYWORD_NAME_<n>	Specifies the name of the nth keyword used as input to the primary generating software named in SOFTWARE_MODULE_NAME.	string			LOCATION <ul style="list-style-type: none"> DERIVED_IMAGE_PARMS (Group) SOURCE <ul style="list-style-type: none"> Image Processing Software
SOFTWARE_KEYWORD_TYPE_<n>	Specifies the data type of the nth keyword used as input to the primary generating software named in SOFTWARE_MODULE_NAME. NOTE: The value of this keyword will be relevant to SOFTWARE_LANGUAGE.	string			LOCATION <ul style="list-style-type: none"> DERIVED_IMAGE_PARMS (Group) SOURCE <ul style="list-style-type: none"> Image Processing Software
SOFTWARE_KEYWORD_VALUE_<n>	Specifies the value of the nth keyword used as input to the primary generating software named in SOFTWARE_MODULE_NAME.	Any valid type			LOCATION <ul style="list-style-type: none"> DERIVED_IMAGE_PARMS (Group) SOURCE <ul style="list-style-type: none"> Image Processing Software
SOFTWARE_LANGUAGE	Specifies the programming language that the primary RDR generating software is written in (eg: IDL)	string			LOCATION <ul style="list-style-type: none"> DERIVED_IMAGE_PARMS (Group) SOURCE <ul style="list-style-type: none"> Image Processing Software
SOFTWARE_MODULE_NAME	Specifies the name of the primary software module used to generate this product. This is the module to which the PDS label entries SOFTWARE_PARAMETER_* and SOFTWARE_KEYWORD_* apply.	string			LOCATION <ul style="list-style-type: none"> DERIVED_IMAGE_PARMS (Group) SOURCE <ul style="list-style-type: none"> Image Processing Software
SOFTWARE_MODULE_TYPE	Specifies the type of the primary software module named in SOFTWARE_MODULE_NAME.	string		"PROCEDURE", "FUNCTION", "SCRIPT"	LOCATION <ul style="list-style-type: none"> DERIVED_IMAGE_PARMS (Group) SOURCE <ul style="list-style-type: none"> Image Processing Software
SOFTWARE_NAME	Specifies the name of data processing software such as a program or a program library.	string(60)		"MERTELEMPROC", other	LOCATION <ul style="list-style-type: none"> HISTORY (Class) SOURCE

Keyword Name	Definition	Type	Units	Valid Values	<ul style="list-style-type: none"> Location in PDS Label Source
					<ul style="list-style-type: none"> Static Value
SOFTWARE_PARAMETER_NAME_<n>	Specifies the name of the nth positional parameter used as input to the primary generating software named in SOFTWARE_MODULE_NAME.	string			<ul style="list-style-type: none"> LOCATION DERIVED_IMAGE_PARMS (Group) SOURCE Image Processing Software
SOFTWARE_PARAMETER_TYPE_<n>	Specifies the data type of the nth positional parameter used as input to the primary generating software named in SOFTWARE_MODULE_NAME. NOTE: The value of this keyword will be relevant to SOFTWARE_LANGUAGE.	string			<ul style="list-style-type: none"> LOCATION DERIVED_IMAGE_PARMS (Group) SOURCE Image Processing Software
SOFTWARE_PARAMETER_VALUE_<n>	Specifies the value of the nth positional parameter used as input to the primary generating software named in SOFTWARE_MODULE_NAME.	Any valid type			<ul style="list-style-type: none"> LOCATION DERIVED_IMAGE_PARMS (Group) SOURCE Image Processing Software
SOFTWARE_VERSION_ID	Specifies the version (development level) of a program or a program library.	string(20)			<ul style="list-style-type: none"> LOCATION HISTORY (Class) SOURCE Static Value
SOLAR_AZIMUTH	Specifies one of two angular measurements indicating the direction to the Sun as measured from a specific point on the surface of a planet (ex., from a lander or rover). The azimuth is measured positively in the clockwise direction (as viewed from above) with the meridian passing through the positive spin axis of the planet (i.e., the north pole) defining the zero reference. 0 <= SOLAR_AZIMUTH <= 360. Units are degrees.	float	deg (<deg> unit tag required)	"0.0" to "359.99" "N/A" if any SPICE kernel is unavailable.	<ul style="list-style-type: none"> LOCATION SITE_DERIVED_GEOMETRY_PARMS (Group) SOURCE Calculated from SPICE using: <ul style="list-style-type: none"> - EK - SCLK - Leapsecond - SPK - PCK - Surface Kernel
SOLAR_ELEVATION	Specifies one of two angular measurements indicating the direction to the Sun as measured from a specific point on the surface of a planet (ex., from a lander or rover). The positive direction of the elevation is set by the POSITIVE_ELEVATION_DIRECTION data element. It is measured from the plane which is normal to the line passing between the surface point and the planet's center of	float	deg (<deg> unit tag required)	"-90.0" to "90.0" "N/A" if any SPICE kernel is unavailable.	<ul style="list-style-type: none"> LOCATION SITE_DERIVED_GEOMETRY_PARMS (Group) SOURCE Calculated from SPICE using: <ul style="list-style-type: none"> - EK - SCLK - Leapsecond - SPK

Keyword Name	Definition	Type	Units	Valid Values	<ul style="list-style-type: none"> Location in PDS Label Source
	mass, and which intersects the surface point. -90 <= SOLAR_ELEVATION <= 90. Units are degrees.				<ul style="list-style-type: none"> - PCK - Surface Kernel
SOLAR_LONGITUDE	Specifies the value of the angle between the body_Sun line at the time of interest and the body_Sun line at the vernal equinox. This provides a measure of season on a target body, with values of 0 to 90 degrees representing northern spring, 90 to 180 degrees representing northern summer, 180 to 270 degrees representing northern autumn and 270 to 360 degrees representing northern winter. For IRAS: the geocentric ecliptic longitude (B1950) of the Sun at the start of a scan.	float	deg	NOTE: Value will be uncalibrated if SPICE kernels are unavailable.	<p>LOCATION</p> <ul style="list-style-type: none"> IDENTIFICATION (Class) <p>SOURCE</p> <ul style="list-style-type: none"> Calculation: <ul style="list-style-type: none"> - UPTH:DataValidityTime - SCLK kernel - P kernel - Landing Site kernel
SOLUTION_ID	<p>Specifies the unique identifier for the solution set to which the values in the group belong.</p> <p>For certain kinds of information (such as pointing correction and rover localization), more than one valid set of values may exist simultaneously. Each of these sets is called a "solution" to the unknown actual value. The SOLUTION_ID is used to identify which solution is being expressed by the containing group.</p> <p>It is recommended that projects adopt a specific naming convention for SOLUTION_ID. The convention will assist the user in identifying a specific instance of values used. Components making up the naming convention for SOLUTION_ID include one or more of the following: date/time, group id, institution, program, purpose, request ID, user, and version. New components may be added as needed.</p> <p>Note: The value of SOLUTION_ID must not be reused for new solutions – it must be globally unique.</p> <p>Note: A single solution can cross many data sets (e.g. for a mosaic). Therefore, you may see an SOLUTION_ID with the</p>	string		"TELEMETRY", etc.	<p>LOCATION</p> <ul style="list-style-type: none"> GEOMETRIC_CAMERA_MODEL (Group) ROVER_COORDINATE_SYSTEM (Group) HGA_ARTICULATION_STATE (Group) IDD_COORDINATE_SYSTEM (Group) PMA_ARTICULATION_STATE (Group) PMA_COORDINATE_SYSTEM (Group) CHASSIS_ARTICULATION_STATE (Group) LOCAL_LEVEL_COORDINATE_SYSTEM (Group) SITE_COORDINATE_SYSTEM (Group) ROVER_DERIVED_GEOMETRY_PARMS (Group) SITE_DERIVED_GEOMETRY_PARMS (Group) <p>SOURCE</p> <ul style="list-style-type: none"> Image Processing Software

Keyword Name	Definition	Type	Units	Valid Values	<ul style="list-style-type: none"> • Location in PDS Label • Source
	<p>same value appearing in many different data sets.</p> <p>For MER, the naming convention consists of several components separated by underscores: "institution_user_purpose_version".</p> <p>Institution or user may be omitted if not relevant. Examples: "mipI_daa_Gallery-Pan_1", "cornell_bell_yogi-closeup_3", "mipI_rgd_sol3nav_5", "MER-A_sol4_1". The last indicates the project-approved "official" solutions for that day. The special name "telemetry" is used for values telemetered from the rover.</p>				
SOURCE_ID	<p>Specifies an identifier for the source.</p> <p>For MER, it identifies the source of command.</p>	string		<p><u>0-0999999999</u> "GROUND COMMANDED"</p> <p><u>1000000000-1299999999</u> "NAV COMMANDED"</p> <p><u>2000000000-2999999999</u> "SAPP COMMANDED"</p> <p><u>3000000000-3999999999</u> "FP COMMANDED"</p> <p><u>4000000000-4294967295</u> "EDL COMMANDED"</p>	<p>LOCATION</p> <ul style="list-style-type: none"> • OBSERVATION_REQUEST_PARMS (Group) • IMAGE_REQUEST_PARMS (Group) • REFERENCE_PIXEL_REQUEST_PARMS (Group) • THUMBNAIL_REQUEST_PARMS (Group) • SUBFRAME_REQUEST_PARMS (Group) • ROW_SUM_REQUEST_PARM (Group) • COLUMN_SUM_REQUEST_PARMS (Group) • SUN_FIND_REQUEST_PARMS (Group) • HISTOGRAM_REQUEST_PRAMS (Group) <p>SOURCE</p> <ul style="list-style-type: none"> • Table lookup: <ul style="list-style-type: none"> - IDPH:ImgParams:image_id
SPACECRAFT_CLOCK_CNT_PARTITION	<p>Specifies the clock partition active for the SPACECRAFT_CLOCK_START_COUNT and SPACECRAFT_CLOCK_STOP_COUNT elements.</p>	integer		"1"	<p>LOCATION</p> <ul style="list-style-type: none"> • IDENTIFICATION (Class) <p>SOURCE</p> <ul style="list-style-type: none"> • Static Value
SPACECRAFT_CLOCK_START_COUNT	<p>Specifies the value of the spacecraft clock at the beginning of a time period of interest.</p> <p>Format is ssssssss.mmm measured in units of seconds, with the field to the right of the decimal in milliseconds, and stored internally as a floating point number.</p>	string(30)			<p>LOCATION</p> <ul style="list-style-type: none"> • IDENTIFICATION (Class) <p>SOURCE</p> <ul style="list-style-type: none"> • Calculation: <ul style="list-style-type: none"> - UPTH:DataValidityTime

Keyword Name	Definition	Type	Units	Valid Values	<ul style="list-style-type: none"> Location in PDS Label Source
SPACECRAFT_CLOCK_STOP_COUNT	<p>Specifies the value of the spacecraft clock at the end of a time period of interest.</p> <p>Format is ssssssssss.mmm measured in units of seconds, with the field to the right of the decimal in milliseconds, and stored internally as a floating point number.</p>	string(30)			<p>LOCATION</p> <ul style="list-style-type: none"> IDENTIFICATION (Class) <p>SOURCE</p> <ul style="list-style-type: none"> Calculation: <ul style="list-style-type: none"> UPTH:DataValidityTime IDPH:ImgTImHdr:exp_time
SPICE_FILE_ID	Specifies an abbreviated name or acronym which identifies a particular SPICE file.	string			<p>LOCATION</p> <ul style="list-style-type: none"> TELEMETRY (Class) <p>SOURCE</p> <ul style="list-style-type: none"> User Parameter
SPICE_FILE_NAME	Specifies the names of the SPICE files used in processing the data. For Galileo, the SPICE files are used to determine navigation and lighting information.	string (180)			<p>LOCATION</p> <ul style="list-style-type: none"> TELEMETRY (Class) <p>SOURCE</p> <ul style="list-style-type: none"> User parameter
STANDARD_DEVIATION	Specifies the standard deviation of the DN values in the image array.	float			<p>LOCATION</p> <ul style="list-style-type: none"> IMAGE (Object) <p>SOURCE</p> <ul style="list-style-type: none"> Calculation
START_AZIMUTH	<p>Specifies the angular distance from a fixed reference position at which an image or observation starts. Azimuth is measured in a spherical coordinate system, in a plane normal to the principal axis. Azimuth values increase according to the right hand rule relative to the positive direction of the principal axis of the spherical coordinate system.</p> <p>When in a SURFACE_PROJECTION group, specifies the azimuth of the left edge of the output map. Applies to CYLINDRICAL and CYLINDRICAL-PERSPECTIVE projections only.</p>	float	deg (<deg> unit tag required)	"0" to "360"	<p>LOCATION</p> <ul style="list-style-type: none"> SURFACE_PROJECTION_PARMS (Group) <p>SOURCE</p> <ul style="list-style-type: none"> Image Processing Software
START_TIME	Specifies the date and time of the beginning of an event or observation (whether it be a spacecraft, ground-based, or system event) in UTC system format..	string		YYYY-MM-DDThh:mm:ss[.fff]Z NOTE: Value will be uncalibrated if SPICE kernels are unavailable.	<p>LOCATION</p> <ul style="list-style-type: none"> IDENTIFICATION (Class) <p>SOURCE</p> <ul style="list-style-type: none"> Calculation: <ul style="list-style-type: none"> UPTH:DataValidityTime SCLK kernel
STOP_AZIMUTH	Specifies the angular distance from a fixed reference position at which an image or	float	deg	"0" to "360"	LOCATION

Keyword Name	Definition	Type	Units	Valid Values	<ul style="list-style-type: none"> Location in PDS Label Source
	<p>reference position at which an image or observation stops. Azimuth is measured in a spherical coordinate system, in a plane normal to the principal axis. Azimuth values increase according to the right hand rule relative to the positive direction of the principal axis of the spherical coordinate system.</p> <p>When in a SURFACE_PROJECTION group, specifies the azimuth of the right edge of the output map. Applies to CYLINDRICAL and CYLINDRICAL-PERSPECTIVE projections only.</p>		(<deg> unit tag required)		<ul style="list-style-type: none"> SURFACE_PROJECTION_PARMS (Group) <p>SOURCE</p> <ul style="list-style-type: none"> Image Processing Software
STOP_TIME	Specifies the date and time of the end of an event or observation (whether it be a spacecraft, ground-based, or system event) in UTC system format.	string		YYYY-MM-DDThh:mm:ss[.fff]Z NOTE: Value will be uncalibrated if SPICE kernels are unavailable.	<p>LOCATION</p> <ul style="list-style-type: none"> IDENTIFICATION (Class) <p>SOURCE</p> <ul style="list-style-type: none"> Calculation: <ul style="list-style-type: none"> UPTH:DataValidityTime IDPH:ImgTImHdr:exp_time SCLK kernel
SUBFRAME_TYPE	<p>Specifies the method of subframing performed on the image.</p> <p>NONE - No subframing requested. SW_ONLY - Software processing only HW_COND - Use hardware only if compatible. HW_SW - Use hardware then software SUN_NO_IMG - If the sun is found, send a subframed image of the sun. If the sun is not found, send back no image. SUN_FULL - If the sun is found, send a subframed image of the sun. If the sun is not found, send back the entire image.</p>	string		0 = "NONE" 1 = "SW_ONLY" 2 = "HW_COND" 3 = "HW_SW" 4 = "SUN_NO_IMG" 5 = "SUN_FULL"	<p>LOCATION</p> <ul style="list-style-type: none"> SUBFRAME_REQUEST_PARMS (Group) <p>SOURCE</p> <ul style="list-style-type: none"> Table Lookup: <ul style="list-style-type: none"> IDPH:ImgParams:subframe
SUN_FIND_FLAG	Specifies whether the sun is located in the image.	string		0 = "FALSE" 1 = "TRUE"	<p>LOCATION</p> <ul style="list-style-type: none"> INSTRUMENT_STATE_PARMS (Group) <p>SOURCE</p> <ul style="list-style-type: none"> Table Lookup: <ul style="list-style-type: none"> IDPH:ImgTImHdr:sun
SUN_FIND_PARM	Specifies the parameters used in finding the sun centroid. Valid if SUN_FIND_FLAG is "TRUE". If SUN_FIND_FLAG is "FALSE", this value	float array[3]			<p>LOCATION</p> <ul style="list-style-type: none"> INSTRUMENT_STATE_PARMS (Group) <p>SOURCE</p>

Keyword Name	Definition	Type	Units	Valid Values	<ul style="list-style-type: none"> • Location in PDS Label • Source
	<p>becomes "N/A".</p> <p>The sun finding parameters are:</p> <p>Sun Finding Request - TRUE if sun finding is requested, regardless of the source of that request (SAPP, GROUND, other).</p> <p>Sun Found Flag - TRUE if the sun was found in the image. If TRUE, then the following fields have useful information. FALSE if sun finding was not attempted, or if it was attempted but the sun was not found.</p> <p>Sun Centroid Window Size - The actual value used for the parameter that determines how large a computation window to use when analyzing the image. This value comes from an internal table, indexed by camera/filter combination, whose values may be changed from the compile-time defaults by using the SET_IMG_SUN command.</p> <p>Sun Centroid Brightness Threshold – The actual value used for the parameter that determines the minimum acceptable "brightness" value, calculated by the sun-finding algorithm, that is required to declare that the sun was found. This value comes from an internal table, indexed by camera/filter combination, whose values may be changed from the compile-time defaults by using the SET_IMG_SUN command.</p> <p>Sun Centroiding Brightness - The actual brightness value calculated by the algorithm. If sun finding was attempted, but failed, this location will still hold the actual value calculated. While there is no guaranteed way to tell if sun-finding was not attempted vs. if it was attempted and failed, this value will be zero if no attempt was made, and almost certainly nonzero if an attempt</p>				<ul style="list-style-type: none"> • Conversion (integer to float): <ul style="list-style-type: none"> - IDPH:ImgTImHdr:sun_wsize • IDPH:ImgTImHdr:sun_thresh • IDPH:ImgTImHdr:sun_brightness

Keyword Name	Definition	Type	Units	Valid Values	<ul style="list-style-type: none"> Location in PDS Label Source
	<p>was made.</p> <p>A further point on brightness. If SAPP wanted to hunt for the sun in multiple images and not stop the first time you saw one that looked right, you could take a full set of images and see if more than one location is reported as where the sun was found, in which case you would select the answer with the largest corresponding brightness value.</p> <p>Sun Row - The full-resolution image row of the sun centroid, if found.</p> <p>Sun Column - The full-resolution image row of the sun centroid, if found.</p> <p>Sun Vector Position - The viewpoint in rover coordinates from which the sun is seen by the camera, if found.</p> <p>Sun Vector Direction - The viewing direction as a unit vector in rover coordinates pointing toward the sun, if found.</p>				
SUN_FIND_PARM_NAME	Specifies the formal name of SUN_FIND_PARM values.	string array[3]		("WINDOW SIZE", "BRIGHTNESS THRESHOLD", "SUMMED BRIGHTNESS")	<p>LOCATION</p> <ul style="list-style-type: none"> INSTRUMENT_STATE_PARMs (Group) <p>SOURCE</p> <ul style="list-style-type: none"> Static Values
SUN_LINE	Specifies the line location of the Sun for atmospheric images, reported by the on board software.	integer			<p>LOCATION</p> <ul style="list-style-type: none"> INSTRUMENT_STATE_PARMs (Group) <p>SOURCE</p> <ul style="list-style-type: none"> IDPH:ImgTImHdr:sun_row
SUN_LINE_SAMPLE	Specifies the sample location of the Sun for atmospheric images, reported by the on board software.	integer			<p>LOCATION</p> <ul style="list-style-type: none"> INSTRUMENT_STATE_PARMs (Group) <p>SOURCE</p> <ul style="list-style-type: none"> IDPH:ImgTImHdr:sun_col
SUN_VIEW_DIRECTION	Specifies a unit vector identifying the sun viewing direction.	float array[3]			<p>LOCATION</p> <ul style="list-style-type: none"> INSTRUMENT_STATE_PARMs (Group) <p>SOURCE</p>

Keyword Name	Definition	Type	Units	Valid Values	<ul style="list-style-type: none"> Location in PDS Label Source
SUN_VIEW_POSITION	Specifies a set of xyz sun viewing position parameters (m).	float array[3]	meters		<ul style="list-style-type: none"> IDPH:ImgTImHdr:sun_view_dir[3] <p>LOCATION</p> <ul style="list-style-type: none"> INSTRUMENT_STATE_PARS (Group) <p>SOURCE</p> <ul style="list-style-type: none"> IDPH:ImgTImHdr:sun_view_pos[3]
SURFACE_GROUND_LOCATION	Specifies any point on the surface (for SURFACE_MODEL_TYPE of "PLANE"). This point is measured in the coordinates specified by the REFERENCE_COORD_SYSTEM_* keywords in the same group.	float array[3]	meters		<p>LOCATION</p> <ul style="list-style-type: none"> SURFACE_MODEL_PARS (Group) <p>SOURCE</p> <ul style="list-style-type: none"> Image Processing Software
SURFACE_MODEL_FILE	Specifies the name of an XYZ or Z-component RDR used as a digital elevation model onto which the data were projected.	string			<p>LOCATION</p> <ul style="list-style-type: none"> SURFACE_MODEL_PARS (Group) <p>SOURCE</p> <ul style="list-style-type: none"> Image Processing Software
SURFACE_MODEL_TYPE	<p>Specifies the type of surface used for the reprojection performed during the mosaicing process.</p> <p>"INFINITY" - refers to an infinitely distant "surface" in all directions and has no parameters.</p> <p>"PLANE" - refers to a flat plane and require the SURFACE_NORMAL_VECTOR and SURFACE_GROUND_LOCATION keywords as parameters.</p> <p>"MIXED" - refers to a mosaic in which the surface models of the included images were NOT all identical in both type and parameters.</p> <p>"DEM" - refers to a surface model defined by a DEM (digital elevation model) and requires SURFACE_MODEL_FILE.</p> <p>"IN_FOCUS_PLANE" - refers to the use of the in-focus plane corresponding to each MI image in an RDR as the surfac for projection of that image. The position and orientation of the in-focus plane are constant in the MI tool frame, allowing the</p>	string		<p>"PLANE", "INFINITY", "MIXED", "DEM", "IN_FOCUS_PLANE"</p>	<p>LOCATION</p> <ul style="list-style-type: none"> SURFACE_MODEL_PARS (Group) <p>SOURCE</p> <ul style="list-style-type: none"> Image Processing Software

Keyword Name	Definition	Type	Units	Valid Values	<ul style="list-style-type: none"> Location in PDS Label Source
	surface(s) used to be defined implicitly. If the RDR contains data from a single image, the plane is also defined explicitly in the SURFACE_MODEL_PARAMS group by Setting REFERENCE_COORD_SYSTEM_NAME, REFERENCE_COORD_SYSTEM_INDEX, SURFACE_NORMAL_VECTOR, and SURFACE_GROUND_LOCATION. In the MI_FRAME for the given image, SURFACE_NORMAL_VECTOR = (0.0, 0.0,-1.0) and SURFACE_GROUND_LOCATION has zero X and Y components and Z equal to a constant derived from calibration data to be 0.0205 m. If the RDR contains multiple images (i.e., is a mosaic) then the latter keywords are omitted.				
SURFACE_NORMAL_VECTOR	Specifies a vector normal to the surface (for SURFACE_MODEL_TYPE of "PLANE"). This vector is measured in the coordinates specified by the REFERENCE_COORD_SYSTEM_* keywords in the same group.	float array[3]			LOCATION <ul style="list-style-type: none"> SURFACE_MODEL_PARAMS (Group) SOURCE <ul style="list-style-type: none"> Image Processing Software
TARGET_DISTANCE	Specifies a measure of the distance from an observing position (e.g., a spacecraft) to a point on a target body. If not specified otherwise, the target point is assumed to be at the center of the instrument field of view.	float	meters (<m> unit tag required)		LOCATION <ul style="list-style-type: none"> GROUND_SUPPORT_EQUIPMENT (Group) SOURCE <ul style="list-style-type: none"> GSE Software
TARGET_NAME	Specifies a target. The target may be a planet, satellite, ring, region, feature, asteroid or comet. See TARGET_TYPE.	string(30)		"MARS", "CALIBRATION"	LOCATION <ul style="list-style-type: none"> Group Dependent: <ul style="list-style-type: none"> a) IDENTIFICATION (Class) b) GROUND_SUPPORT_EQUIPMENT (Group) SOURCE <ul style="list-style-type: none"> Group Dependent: <ul style="list-style-type: none"> a) Calculated by algorithm to determine if looking at the calibration target, if not, then MARS: <ul style="list-style-type: none"> - IDPH:ImgTImHdr;pma_final.azimuth - IDPH:ImgTImHdr;pma_final.elevation b) GSE software
TARGET_TYPE	Specifies the type of a named target.	string		"CALIBRATION", "DUST", "N/A", "SUN", "PLANET"	LOCATION <ul style="list-style-type: none"> Group Dependent: <ul style="list-style-type: none"> a) IDENTIFICATION (Class)

Keyword Name	Definition	Type	Units	Valid Values	<ul style="list-style-type: none"> Location in PDS Label Source
					<ul style="list-style-type: none"> b) GROUND SUPPORT EQUIPMENT <p>SOURCE</p> <ul style="list-style-type: none"> Group Dependent: <ul style="list-style-type: none"> a) Static Value – “PLANET” b) GSE Software
TELEMETRY_PROVIDER_ID	Specifies the provider and version of the telemetry data used in the generation of this data.	string		“SSW MER_DP”, “TTACS”	<p>LOCATION</p> <ul style="list-style-type: none"> TELEMETRY (Class) <p>SOURCE</p> <ul style="list-style-type: none"> User Parameter
TELEMETRY_SOURCE_NAME	Specifies the name of the telemetry source used in creation of this data set.	string			<p>LOCATION</p> <ul style="list-style-type: none"> TELEMETRY (Class) <p>SOURCE</p> <ul style="list-style-type: none"> Input DP filename
TELEMETRY_SOURCE_TYPE	Specifies the classification of the source of the telemetry used in creating this data set.	string(12)		“SFDU”, “DATA PRODUCT”	<p>LOCATION</p> <ul style="list-style-type: none"> TELEMETRY (Class) <p>SOURCE</p> <ul style="list-style-type: none"> User Parameter
TEST_PHASE_NAME	Specifies the phase of a test for instrument calibration.	string		“DEVELOPMENT”, “CHECKOUT”, “CALIBRATION”, “INTEGRATION AND TEST”	<p>LOCATION</p> <ul style="list-style-type: none"> GROUND_SUPPORT_EQUIPMENT (Group) <p>SOURCE</p> <ul style="list-style-type: none"> GSE Software
TLM_CMD_DISCREPANCY_FLAG	Specifies whether or not discrepancies were found between the uplinked commands and the downlinked telemetry.	string(5)		0 = “FALSE” 1 = “TRUE”	<p>LOCATION</p> <ul style="list-style-type: none"> TELEMETRY (Class) <p>SOURCE</p> <ul style="list-style-type: none"> Calculation
X_AXIS_MAXIMUM	Specifies the value of the X coordinate of a Vertical or Orthographic projection at the top of the image. Note that +X is at the top of the image and +Y is at the right, so +X corresponds to North.	float	meters (<m> unit tag required)		<p>LOCATION</p> <ul style="list-style-type: none"> SURFACE_PROJECTION_PARMS (Group) <p>SOURCE</p> <ul style="list-style-type: none"> Image Processing Software
X_AXIS_MINIMUM	Specifies the value of the X coordinate of a Vertical or Orthographic projection at the bottom of the image.	float	meters (<m> unit tag required)		<p>LOCATION</p> <ul style="list-style-type: none"> SURFACE_PROJECTION_PARMS (Group) <p>SOURCE</p> <ul style="list-style-type: none"> Image Processing Software
Y_AXIS_MAXIMUM	Specifies the value of the Y coordinate of a Vertical or Orthographic projection at the right edge of the image.	float	meters (<m> unit tag required)		<p>LOCATION</p> <ul style="list-style-type: none"> SURFACE_PROJECTION_PARMS (Group) <p>SOURCE</p>

Keyword Name	Definition	Type	Units	Valid Values	<ul style="list-style-type: none"> Location in PDS Label Source
			required)		<ul style="list-style-type: none"> Image Processing Software
Y_AXIS_MINIMUM	Specifies the value of the Y coordinate of a Vertical or Orthographic projection at the left edge of the image.	float	meters (<m> unit tag required)		<ul style="list-style-type: none"> LOCATION SURFACE_PROJECTION_PARAMS (Group) SOURCE Image Processing Software
ZERO_ELEVATION_LINE	Specifies the image line representing 0.0 degree elevation. Applies to Cylindrical projections.	float	pixel (<pixel> unit tag required)		<ul style="list-style-type: none"> LOCATION SURFACE_PROJECTION_PARAMS (Group) SOURCE Image Processing Software
ZERO_EXPOSURE_IMAGE	Specifies the value of PRODUCT_ID for the zero-exposure EDR that is subtracted during RDR generation to account for shutter smear and masked-region dark current. NOTE: This keyword is only placed in the PDS label if a zero-exposure image EDR product was used during on-ground calibration. It is not set when on-board shutter-subtraction is done.	string			<ul style="list-style-type: none"> LOCATION DERIVED_IMAGE_PARAMS (Group) SOURCE Image Processing Software

APPENDIX C – “12 to 8-bit” Inverse Lookup Tables (ILUTs)

8-bit DN	ILUT #1 12-bit DN	ILUT #2 12-bit DN	ILUT #3 12-bit DN	ILUT #4 12-bit DN	ILUT #5 12-bit DN
0	20	0	0	N/A	N/A
1	21	1	1	N/A	N/A
2	22	2	2	N/A	N/A
3	23	3	3	N/A	N/A
4	24	4	4	N/A	N/A
5	25	5	5	N/A	N/A
6	27	7	7	N/A	N/A
7	28	8	8	N/A	N/A
8	30	10	10	N/A	N/A
9	31	11	11	N/A	N/A
10	33	13	13	N/A	N/A
11	35	15	15	N/A	N/A
12	36	16	17	N/A	N/A
13	38	18	19	N/A	N/A
14	40	20	21	N/A	N/A
15	42	22	23	N/A	N/A
16	45	25	25	N/A	N/A
17	47	27	27	N/A	N/A
18	49	29	29	N/A	N/A
19	52	32	32	N/A	N/A
20	54	34	35	N/A	N/A
21	57	37	37	N/A	N/A
22	60	40	40	N/A	N/A
23	63	43	43	N/A	N/A
24	66	46	46	N/A	N/A
25	69	49	50	N/A	N/A
26	72	52	53	N/A	N/A
27	76	56	56	N/A	N/A
28	80	60	60	N/A	N/A
29	83	63	64	N/A	N/A
30	87	67	68	N/A	N/A
31	91	71	72	N/A	N/A
32	95	75	76	N/A	N/A
33	99	79	80	N/A	N/A
34	103	83	84	N/A	N/A
35	108	88	88	N/A	N/A
36	112	92	93	N/A	N/A
37	117	97	98	N/A	N/A
38	121	101	102	N/A	N/A
39	126	106	107	N/A	N/A
40	131	111	112	N/A	N/A
41	136	116	117	N/A	N/A
42	141	121	123	N/A	N/A
43	147	127	128	N/A	N/A

8-bit DN	ILUT #1 12-bit DN	ILUT #2 12-bit DN	ILUT #3 12-bit DN	ILUT #4 12-bit DN	ILUT #5 12-bit DN
44	152	132	134	N/A	N/A
45	158	138	139	N/A	N/A
46	164	144	145	N/A	N/A
47	170	150	151	N/A	N/A
48	176	156	157	N/A	N/A
49	182	162	163	N/A	N/A
50	188	168	170	N/A	N/A
51	194	174	176	N/A	N/A
52	201	181	182	N/A	N/A
53	207	187	189	N/A	N/A
54	214	194	196	N/A	N/A
55	220	200	202	N/A	N/A
56	227	207	210	N/A	N/A
57	234	214	217	N/A	N/A
58	242	222	224	N/A	N/A
59	249	229	232	N/A	N/A
60	257	237	239	N/A	N/A
61	264	244	247	N/A	N/A
62	272	252	255	N/A	N/A
63	280	260	263	N/A	N/A
64	288	268	271	N/A	N/A
65	296	276	279	N/A	N/A
66	304	284	287	N/A	N/A
67	312	292	295	N/A	N/A
68	321	301	304	N/A	N/A
69	329	309	312	N/A	N/A
70	338	318	321	N/A	N/A
71	346	326	330	N/A	N/A
72	355	335	339	N/A	N/A
73	364	344	348	N/A	N/A
74	374	354	357	N/A	N/A
75	383	363	367	N/A	N/A
76	392	372	376	N/A	N/A
77	402	382	386	N/A	N/A
78	412	392	396	N/A	N/A
79	422	402	406	N/A	N/A
80	432	412	416	N/A	N/A
81	442	422	426	N/A	N/A
82	452	432	436	N/A	N/A
83	462	442	447	N/A	N/A
84	472	452	457	N/A	N/A
85	483	463	468	N/A	N/A
86	493	473	478	N/A	N/A
87	504	484	489	N/A	N/A
88	515	495	500	N/A	N/A
89	526	506	512	N/A	N/A
90	537	517	523	N/A	N/A

8-bit DN	ILUT #1 12-bit DN	ILUT #2 12-bit DN	ILUT #3 12-bit DN	ILUT #4 12-bit DN	ILUT #5 12-bit DN
91	549	529	534	N/A	N/A
92	560	540	546	N/A	N/A
93	572	552	558	N/A	N/A
94	583	563	570	N/A	N/A
95	595	575	582	N/A	N/A
96	607	587	594	N/A	N/A
97	619	599	606	N/A	N/A
98	631	611	618	N/A	N/A
99	644	624	630	N/A	N/A
100	656	636	643	N/A	N/A
101	668	648	655	N/A	N/A
102	681	661	668	N/A	N/A
103	694	674	681	N/A	N/A
104	707	687	694	N/A	N/A
105	720	700	707	N/A	N/A
106	733	713	721	N/A	N/A
107	746	726	734	N/A	N/A
108	760	740	748	N/A	N/A
109	773	753	762	N/A	N/A
110	787	767	775	N/A	N/A
111	801	781	789	N/A	N/A
112	815	795	803	N/A	N/A
113	829	809	818	N/A	N/A
114	843	823	832	N/A	N/A
115	857	837	846	N/A	N/A
116	871	851	861	N/A	N/A
117	886	866	875	N/A	N/A
118	900	880	890	N/A	N/A
119	915	895	905	N/A	N/A
120	930	910	920	N/A	N/A
121	945	925	935	N/A	N/A
122	960	940	951	N/A	N/A
123	976	956	966	N/A	N/A
124	991	971	982	N/A	N/A
125	1007	987	998	N/A	N/A
126	1022	1002	1013	N/A	N/A
127	1038	1018	1029	N/A	N/A
128	1054	1034	1045	N/A	N/A
129	1070	1050	1062	N/A	N/A
130	1086	1066	1078	N/A	N/A
131	1102	1082	1094	N/A	N/A
132	1119	1099	1111	N/A	N/A
133	1135	1115	1127	N/A	N/A
134	1152	1132	1144	N/A	N/A
135	1169	1149	1161	N/A	N/A
136	1185	1165	1178	N/A	N/A
137	1202	1182	1196	N/A	N/A

8-bit DN	ILUT #1 12-bit DN	ILUT #2 12-bit DN	ILUT #3 12-bit DN	ILUT #4 12-bit DN	ILUT #5 12-bit DN
138	1220	1200	1213	N/A	N/A
139	1237	1217	1230	N/A	N/A
140	1254	1234	1248	N/A	N/A
141	1272	1252	1266	N/A	N/A
142	1290	1270	1284	N/A	N/A
143	1308	1288	1302	N/A	N/A
144	1326	1306	1320	N/A	N/A
145	1344	1324	1338	N/A	N/A
146	1362	1342	1356	N/A	N/A
147	1380	1360	1375	N/A	N/A
148	1398	1378	1393	N/A	N/A
149	1417	1397	1412	N/A	N/A
150	1435	1415	1431	N/A	N/A
151	1454	1434	1450	N/A	N/A
152	1473	1453	1469	N/A	N/A
153	1492	1472	1488	N/A	N/A
154	1511	1491	1507	N/A	N/A
155	1530	1510	1527	N/A	N/A
156	1550	1530	1547	N/A	N/A
157	1569	1549	1566	N/A	N/A
158	1589	1569	1586	N/A	N/A
159	1609	1589	1606	N/A	N/A
160	1629	1609	1626	N/A	N/A
161	1649	1629	1647	N/A	N/A
162	1669	1649	1667	N/A	N/A
163	1689	1669	1687	N/A	N/A
164	1709	1689	1708	N/A	N/A
165	1730	1710	1729	N/A	N/A
166	1750	1730	1749	N/A	N/A
167	1771	1751	1770	N/A	N/A
168	1792	1772	1791	N/A	N/A
169	1813	1793	1813	N/A	N/A
170	1834	1814	1834	N/A	N/A
171	1855	1835	1856	N/A	N/A
172	1877	1857	1877	N/A	N/A
173	1898	1878	1899	N/A	N/A
174	1920	1900	1921	N/A	N/A
175	1942	1922	1943	N/A	N/A
176	1964	1944	1965	N/A	N/A
177	1986	1966	1987	N/A	N/A
178	2008	1988	2010	N/A	N/A
179	2030	2010	2032	N/A	N/A
180	2052	2032	2055	N/A	N/A
181	2075	2055	2077	N/A	N/A
182	2097	2077	2100	N/A	N/A
183	2120	2100	2123	N/A	N/A
184	2143	2123	2146	N/A	N/A

8-bit DN	ILUT #1 12-bit DN	ILUT #2 12-bit DN	ILUT #3 12-bit DN	ILUT #4 12-bit DN	ILUT #5 12-bit DN
185	2166	2146	2170	N/A	N/A
186	2189	2169	2193	N/A	N/A
187	2213	2193	2217	N/A	N/A
188	2236	2216	2241	N/A	N/A
189	2260	2240	2264	N/A	N/A
190	2283	2263	2288	N/A	N/A
191	2307	2287	2312	N/A	N/A
192	2331	2311	2336	N/A	N/A
193	2355	2335	2361	N/A	N/A
194	2379	2359	2385	N/A	N/A
195	2403	2383	2409	N/A	N/A
196	2428	2408	2434	N/A	N/A
197	2452	2432	2459	N/A	N/A
198	2477	2457	2484	N/A	N/A
199	2501	2481	2509	N/A	N/A
200	2526	2506	2534	N/A	N/A
201	2551	2531	2559	N/A	N/A
202	2576	2556	2585	N/A	N/A
203	2602	2582	2610	N/A	N/A
204	2627	2607	2636	N/A	N/A
205	2652	2632	2662	N/A	N/A
206	2678	2658	2688	N/A	N/A
207	2704	2684	2714	N/A	N/A
208	2730	2710	2740	N/A	N/A
209	2756	2736	2766	N/A	N/A
210	2782	2762	2792	N/A	N/A
211	2808	2788	2819	N/A	N/A
212	2834	2814	2845	N/A	N/A
213	2861	2841	2872	N/A	N/A
214	2887	2867	2899	N/A	N/A
215	2914	2894	2926	N/A	N/A
216	2941	2921	2953	N/A	N/A
217	2968	2948	2981	N/A	N/A
218	2995	2975	3008	N/A	N/A
219	3022	3002	3036	N/A	N/A
220	3050	3030	3063	N/A	N/A
221	3077	3057	3091	N/A	N/A
222	3105	3085	3119	N/A	N/A
223	3133	3113	3147	N/A	N/A
224	3161	3141	3175	N/A	N/A
225	3189	3169	3204	N/A	N/A
226	3217	3197	3232	N/A	N/A
227	3245	3225	3261	N/A	N/A
228	3273	3253	3289	N/A	N/A
229	3302	3282	3318	N/A	N/A
230	3330	3310	3347	N/A	N/A
231	3359	3339	3376	N/A	N/A

8-bit DN	ILUT #1 12-bit DN	ILUT #2 12-bit DN	ILUT #3 12-bit DN	ILUT #4 12-bit DN	ILUT #5 12-bit DN
232	3388	3368	3405	N/A	N/A
233	3417	3397	3435	N/A	N/A
234	3446	3426	3464	N/A	N/A
235	3475	3455	3494	N/A	N/A
236	3505	3485	3523	N/A	N/A
237	3534	3514	3553	N/A	N/A
238	3564	3544	3583	N/A	N/A
239	3594	3574	3613	N/A	N/A
240	3624	3604	3643	N/A	N/A
241	3654	3634	3674	N/A	N/A
242	3684	3664	3704	N/A	N/A
243	3714	3694	3735	N/A	N/A
244	3744	3724	3765	N/A	N/A
245	3775	3755	3796	N/A	N/A
246	3805	3785	3827	N/A	N/A
247	3836	3816	3858	N/A	N/A
248	3867	3847	3889	N/A	N/A
249	3898	3878	3921	N/A	N/A
240	3624	3604	3643	N/A	N/A
241	3654	3634	3674	N/A	N/A
242	3684	3664	3704	N/A	N/A
243	3714	3694	3735	N/A	N/A
244	3744	3724	3765	N/A	N/A
245	3775	3755	3796	N/A	N/A
246	3805	3785	3827	N/A	N/A
247	3836	3816	3858	N/A	N/A
248	3867	3847	3889	N/A	N/A
249	3898	3878	3921	N/A	N/A
250	3929	3909	3952	N/A	N/A
251	3960	3940	3984	N/A	N/A
252	3991	3971	4016	N/A	N/A
253	4023	4003	4047	N/A	N/A
254	4055	4035	4079	N/A	N/A
255	4083	4095	4095	N/A	N/A

APPENDIX D – Radiometric Correction Files and Parameters

SCID (Mission)	Instr.	Camera SN	Filter Position	Flat Field Filename	Responsivity Parameters R0, R1, R2
2 (MER-A)	Pancam Left	104	1	MER_FLAT_SN_104_F_1.IMG	3.174E-07, -2.111E-11, 0.0
			2	MER_FLAT_SN_104_F_2.IMG	4.470E-06, 2.241E-09, 0.0
			3	MER_FLAT_SN_104_F_3.IMG	8.123E-06, 1.041E-08, 0.0
			4	MER_FLAT_SN_104_F_4.IMG	9.792E-06, 1.669E-08, 0.0
			5	MER_FLAT_SN_104_F_5.IMG	1.504E-05, 2.814E-08, 0.0
			6	MER_FLAT_SN_104_F_6.IMG	1.751E-05, 4.282E-08, 0.0
			7	MER_FLAT_SN_104_F_7.IMG	4.253E-05, 1.293E-07, 0.0
			8	MER_FLAT_SN_104_F_8.IMG	7.14, 5.64E-03, 0.0
2 (MER-A)	Pancam Right	103	1	MER_FLAT_SN_103_F_1.IMG	5.040E-05, 3.039E-07, 0.0
			2	MER_FLAT_SN_103_F_2.IMG	4.427E-06, 2.596E-09, 0.0
			3	MER_FLAT_SN_103_F_3.IMG	5.489E-06, -1.707E-09, 0.0
			4	MER_FLAT_SN_103_F_4.IMG	8.537E-06, -1.462E-08, 0.0
			5	MER_FLAT_SN_103_F_5.IMG	5.798E-06, -1.575E-08, 0.0
			6	MER_FLAT_SN_103_F_6.IMG	7.633E-06, -2.871E-08, 0.0
			7	MER_FLAT_SN_103_F_7.IMG	9.292E-06, -7.973E-08, 0.0
			8	MER_FLAT_SN_103_F_8.IMG	0.5049, -9.29E-04, 0.0
2 (MER-A)	Navcam Left	112	n/a	MER_FLAT_SN_112.IMG	7.066E-06, 1.437E-09, 0.0
2 (MER-A)	Navcam Right	113	n/a	MER_FLAT_SN_113.IMG	7.066E-06, 1.437E-09, 0.0
2 (MER-A)	Front Hazcam Left	107	n/a	MER_FLAT_SN_107.IMG	7.066E-06, 1.437E-09, 0.0
2 (MER-A)	Front Hazcam Right	109	n/a	MER_FLAT_SN_109.IMG	7.066E-06, 1.437E-09, 0.0
2 (MER-A)	Rear Hazcam Left	106	n/a	MER_FLAT_SN_106.IMG	7.066E-06, 1.437E-09, 0.0
2 (MER-A)	Rear Hazcam Right	108	n/a	MER_FLAT_SN_108.IMG	7.066E-06, 1.437E-09, 0.0
2 (MER-A)	MI	105	1	missing	missing
			2	missing	missing
1 (MER-B)	Pancam Left	115	1	MER_FLAT_SN_115_F_1.IMG	3.330E-07, -1.029E-11, 0.0
			2	MER_FLAT_SN_115_F_2.IMG	4.750E-06, 3.607E-09, 0.0
			3	MER_FLAT_SN_115_F_3.IMG	8.611E-06, 1.345E-08, 0.0
			4	MER_FLAT_SN_115_F_4.IMG	9.891E-06, 1.803E-08, 0.0
			5	MER_FLAT_SN_115_F_5.IMG	1.588E-05, 3.288E-08, 0.0
			6	MER_FLAT_SN_115_F_6.IMG	1.813E-05, 4.290E-08, 0.0
			7	MER_FLAT_SN_115_F_7.IMG	5.065E-05, 1.717E-07, 0.0
			8	MER_FLAT_SN_115_F_8.IMG	7.33, 7.04E-03, 0.0

SCID (Mission)	Instr.	Camera SN	Filter Position	Flat Field Filename	Responsivity Parameters R0, R1, R2
1 (MER-B)	Pancam Right	114	1	MER_FLAT_SN_114_F_1.IMG	4.198E-05, 1.167E-07, 0.0
			2	MER_FLAT_SN_114_F_2.IMG	4.607E-06, 1.920E-09, 0.0
			3	MER_FLAT_SN_114_F_3.IMG	6.023E-06, -2.704E-09, 0.0
			4	MER_FLAT_SN_114_F_4.IMG	8.454E-06, -1.474E-08, 0.0
			5	MER_FLAT_SN_114_F_5.IMG	5.766E-06, -1.646E-08, 0.0
			6	MER_FLAT_SN_114_F_6.IMG	7.607E-06, -3.036E-08, 0.0
			7	MER_FLAT_SN_114_F_7.IMG	1.009E-05, -1.067E-07, 0.0
			8	MER_FLAT_SN_114_F_8.IMG	0.405, -8.59E-04, 0.0
1 (MER-B)	Navcam Left	102	n/a	MER_FLAT_SN_102.IMG	7.066E-06, 1.437E-09, 0.0
1 (MER-B)	Navcam Right	117	n/a	MER_FLAT_SN_117.IMG	1.2719-05, 1.437E-09, 0.0
1 (MER-B)	Front Hazcam Left	120	n/a	MER_FLAT_SN_120.IMG	7.066E-06, 1.437E-09, 0.0
1 (MER-B)	Front Hazcam Right	122	n/a	MER_FLAT_SN_122.IMG	7.066E-06, 1.437E-09, 0.0
1 (MER-B)	Rear Hazcam Left	119	n/a	MER_FLAT_SN_119.IMG	7.066E-06, 1.437E-09, 0.0
1 (MER-B)	Rear Hazcam Right	121	n/a	MER_FLAT_SN_121.IMG	7.066E-06, 1.437E-09, 0.0
1 (MER-B)	MI	110	1	missing	missing
			2	missing	missing

Note: The measured responsivity value for SN 117 (MER B, right Navcam) differs from the rest of the Navcams/Hazcams.